

These Rolling Stock Information Sheets have been compiled to provide some key technical data and illustrations on the current passenger fleet in operation across the whole London Underground network. By way of comparison, a short illustrative insight is also provided into some of the older (withdrawn) passenger stock of the past. From which much has been learnt in the evolution of technical and design development for today's fleet. In addition, there is also some basic information about some of the engineer's rolling stock in use.

The information is not totally comprehensive – such a publication would require many volumes. Therefore, should you require any further information, please contact Graham Neil, LU's Rolling Stock Engineer, in the first instance.

Thanks go to the representatives of LU's business partners and associates in Tube Lines and Metronet; Transplant; LU Contracts department; London's transport Museum; Transport for London's (TfL) Visual Image Service; TfL's marketing communications and Corporate Design department and others for their assistance in the provision of information and assistance in the production of this publication.



Equipment details

Bodies:	Welded steel underframe riveted aluminium frame and unpainted aluminium alloy panelling. Exterior painted on refurbishment in LUL corporate red, white
Bogies:	4-wheel symmetrical plate frame bogies of welded/riveted construction. Wheel diameter – 2ft 6 ins.
Couplers:	London Underground Automatic Wedgelock between units, semi-permanent tray between cars within a unit.
Traction system:	A.E.I. Traction pneumatic single camshaft, resistance controller with series/parallel grouping and 2 stages of weak field. Crompton Parkinson Brush LT115 axle-hung, nose-suspended motors, 16/65 gear ratio, 4 per driving motor car, 1 per driving axle, the two motors on each bogie are connected in permanent series.
Compressors:	Reavell TBC38Z (reciprocating), 1 on each trailer.
Brakes:	Rheostatic on Driving Motor cars. 1 air-operated brake block per wheel on all cars. Service braking – Rheostatic and staged e.p. with mercury retarders Note that the rheostatic brake does all the braking at low brake rate and low passenger load. As the rate and/or load increase, trailer (air) brakes are applied, then motor (air) brakes. Emergency braking – e.p. and Westinghouse automatic air brake. Parking brake – Automatic spring-applied, air released.
A.T.O.:	John Kent driver box controlled by discrete track command spots.
A.T.P.:	Westinghouse safety box controlled by mechanical governor and coded track circuits.
Auxiliary power supplies:	One A.E.I Traction Motor- Alternator-Rectifier (type MG3005 & MG3007), one per trailer car.
Main lighting:	115V ac Fluorescent tubes – 12x5ft, 4x4ft, 4x2ft and 4x'D' tubes (2x2ft and 2x'D' tubes less on driving motor cars). All are inverter driven and fed by a 115V ac supply.
Emergency lighting:	2 inverter-fed, 50V dc powered, fluorescent tubes per car.



1967 Tube Stock

Victoria line



Built by Metro-Cammell, Birmingham 1967 - 1969

Entered service Victoria line 1968-1971

Refurbished by Tickford Rail Limited at Rosyth Royal Dockyard 1991-1995

Maintained by: Metronet Rail BCV Ltd

Principal characteristics

Track gauge:	4ft 8½ ins/1435mm
Current system:	630V dc 3 rd and 4 th rail, floating earth
Types of vehicle:	Driving Motor (DM); Trailer (T)
Formation per unit:	Four cars, formed DM – T – T – DM
Formation per train:	Eight cars, formed DM – T – T – DM + DM – T – T – DM
Number of train:	43 Eight-car trains.
Operation:	One person operated. Doors operating by train operator in the leading cab. Automatic train operation (A.T.O.). Manual driving (coded manual or slow manual). Some cabs (including all ex-1972MkI DM cars) are no longer fitted with full ATC equipment and have been downgraded to 'middle motor' status. These can be used for shunting in the depots.

Information sheet date: March 2007



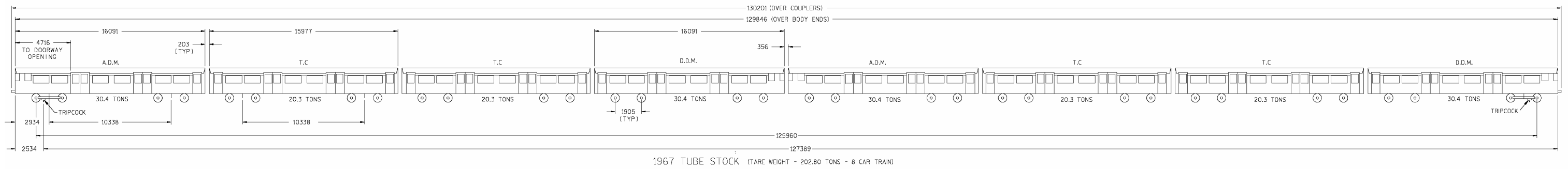

Vehicle details and statistics

	Driving Motor Car	Trailer Car
Length over body ends:	52ft 9ins	52ft 5ins
Width of body:	8ft 8ins	8ft 8ins
Car height:	9ft 5¼ins	9ft 5¼ins
Tare weight	30.4 tons	20.3 tons
Tare weight of 8-car train:	202.80 tons	
Passenger door open width (double):	4ft 6ins	4ft 6ins
(single):	2ft 3ins	2ft 3ins
Car number series:	3001-3086	4001-4086
	3101-3186	4101-4186
Vehicles in stock:	172	172
Grand total in stock	344	

It should be noted that 28 cars (14 driving motors and 14 trailers) were converted in 1987-1989 from Northern line crew-operated 1972 MKI tube stock. A further 3 cars (2 driving motors and 1 trailer) were converted in 1995-1999.

Passenger accommodation:

Please note that standing capacity figures exclude seating capacity

Seating capacity: (Number of seats per train)	304
Standing capacities: Floor area available for standing passengers (m ²) ^a	132.24
Maximum observed standing capacity (5 customers per m ²)	661
Maximum full load standing capacity (6 customers per m ²) ^b	793
Theoretical crush standing capacity (7 customers per m ²) ^c	926

NOTES:

- Capacities here are figures **calculated** from floor area for design purposes
- For propulsion performance rating
- For structural and braking capacity

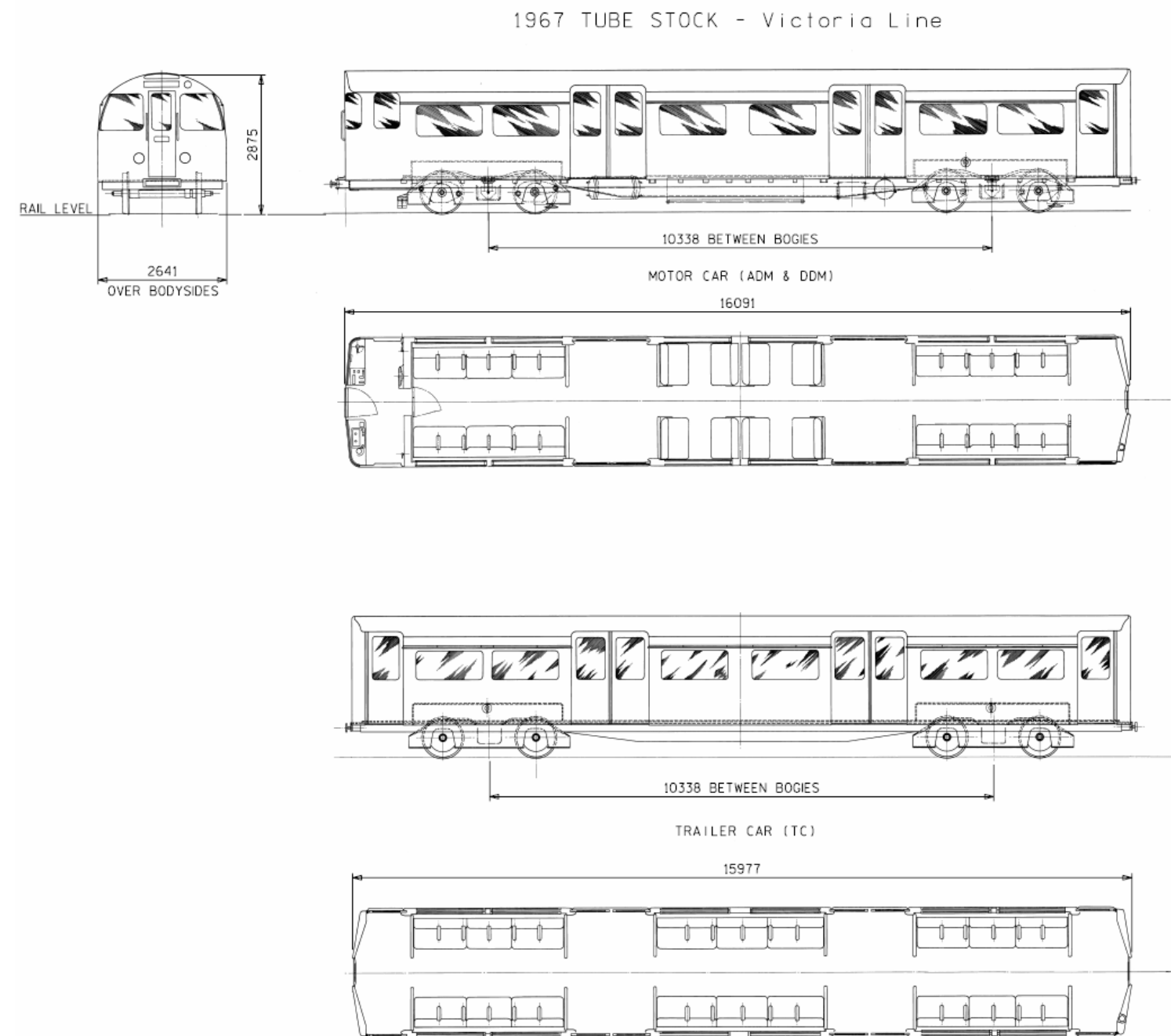

Equipment details

Bodies:	Welded steel underframe riveted aluminium frame and aluminium alloy panelling. Exterior painted on refurbishment in LUL corporate red, white and blue livery.
Bogies:	4-wheel symmetrical plateframe bogies of welded/riveted construction. Wheel diameter, new, 31ins.
Couplers:	London Underground Automatic Wedglock between units, semi-permanent tray between cars within a unit.
Traction system:	A.E.I. Traction pneumatic single camshaft, resistance controller with series/parallel grouping and 2 stages of weak field. Brush LT115 axle-hung, nose-suspended motors, 16/65 gear ratio, 4 per driving motor car, 1 per driving axle, the two motors on each bogie are connected in permanent series.
Compressors:	Reavell TBC38Z or Westinghouse 3HC43 (reciprocating), 1 on each trailer.
Brakes:	Rheostatic on Driving Motor cars. 1 air-operated brake block per wheel on all cars. Service braking – Rheostatic and staged e.p. with mercury retarders. Note that the rheostatic brake does all the braking at low brake rate and low passenger load. As the rate and/or load increase, trailer (air) brakes are applied, then motor (air) brakes. Emergency braking – e.p. and Westinghouse automatic air brake. Parking brake – Automatic spring-applied, air released.
Auxiliary power supplies:	One A.E.I Traction Motor- Alternator-Rectifier (MG3007), per trailer car.
Main lighting:	115V ac Fluorescent tubes – 12x5ft, 4x4ft, 4x2ft and 4x'D' tubes (2x2ft and 2x'D' tubes less on driving motor cars). All are inverter driven and fed by a 115V ac supply.
Emergency lighting:	Two of the 4ft tubes in each car are fed from a 50V dc supply. In addition, all 2ft tubes on cars in 4-car units are similarly fed.



1972 MkI and MkII Tube Stocks

Bakerloo line



Built by Metro-Cammell, Birmingham 1972 - 1974

Entered service Northern line 1972-1975

Refurbished by Tickford Rail Limited at Rosyth Royal Dockyard 1991-1995

Maintained by: Metronet Rail BCV Ltd

Principal characteristics

Track gauge:	4ft 8½ ins/1435mm
Current system:	630V dc 3 rd and 4 th rail, floating earth
Types of vehicle:	Driving Motor (DM); Trailer (T); Uncoupling Non-Driving Motor (UNDM)
Formation per unit:	Four cars, formed DM – T – T – DM*, and three cars formed UNDM – T – DM
Formation per train:	Eight cars, formed DM – T – T – DM + UNDM – T – DM* 8 one train is formed of DM – T – T – UNDM – UNDM – T – DM
Number of train:	36 seven-car trains.
Operation:	Conventional O.P.O. driving with doors operated by train operator in leading cab.

Information sheet date: March 2007



Equipment details

Bodies:	Welded steel underframe riveted aluminium body frame and aluminium alloy panelling. Exterior painted on refurbishment in LUL corporate red, white and blue livery.
Bogies:	4-wheel symmetrical plateframe bogies of welded/riveted construction. Wheel diameter 790mm new, 710mm worn.
Couplers:	London Underground Automatic Wedglock between units, semi-permanent bar between cars within a unit.
Traction system:	G.E.C. Traction pneumatic single camshaft, resistance controller with series/parallel grouping and 2 stages of weak field and rheostatic dynamic brake. Brush LT118 axle-hung, nose-suspended motors, 300 volt motors, 17/75 gear ratio, 4 per driving motor car, 1 per driving axle, the two motors on each bogie are connected in permanent series.
Compressors:	Westinghouse 3HC43 (reciprocating) with integral 630V dc motor, 1 on each single-ended trailer, 2 on special trailers (double-ended units)
Brakes:	Service brake: Motor cars – blended rheostatic/friction brake with load control. Trailer cars – friction brake with load control. Friction brake – one brake per wheel. Emergency Brake: All cars – Friction brake. Brake control: via energise to release Westcode 7-step valve. Steps 3,4,5,6, for service, step 7 for emergency. Service brake: Energise to apply 3-wire control system. Emergency: Energise to release electric control. Parking brake: Automatic spring-applied, air released.
Auxiliary power supplies:	G.E.C. Traction type MG3007 Motor- Alternator-Rectifier – one per motor car, nominal 50V lead acid battery, 77Ah, Powernetics 6kVA single phase, 240V, 50Hz static converter to feed saloon fans and cab air conditioning – one per trailer.
Main lighting:	115V, 850Hz supply from the motor alternator supplying fluorescent tubes via individual inverters – 20 tubes per driving motor car and 22 tubes per trailer/UNDM car.
Emergency lighting:	Four battery-fed fluorescent tubes per car supplied by individual inverters and normally forming part of the main saloon lighting.
Heating:	Panel heaters, 4.2kW per car.
Ventilation:	Seven extractor fans per car, two of which are inverter-fed from the battery. Manually operated ventilators over saloon side windows.
Passenger Information:	Six LED, scrolling visual display units per car. Semi-automatic audio station announcements. Passenger alarm with talkback to driver.
Doors:	Pneumatically operated sliding doors. Two double and one single per side (driving motor cars), two double and two single per side (trailer and UNDM cars).
Train Protection	Tripcocks/train stops/deadman's handle.

1973 Tube Stocks

Piccadilly line



Built by Metro-Cammell, Birmingham 1974 - 1977

Entered service Piccadilly line 1975-1978

Refurbished by Bombardier Prorail 1995-2000

Maintained by: Tube Lines

Principal characteristics

Track gauge:	4ft 8½ ins/1435mm
Current system:	630V dc 3 rd and 4 th rail, floating earth
Types of vehicle:	Driving Motor (DM); Trailer (T); Uncoupling Non-Driving Motor (UNDM), Double End Driving Motor (DM*), Special Trailer (T*).
Formation per unit:	Three cars, formed DM – T – UNDM (152 units) or DM* – T* – DM* (21 units)
Formation per train:	Eight cars, formed DM – T – UNDM + UNDM – T – DM DM* – T* – DM* + UNDM – T – DM DM – T – UNDM + DM* – T – DM* DM* – T – DM* + DM* – T – DM*
Number of train:	86.5 six-car trains.
Operation:	Conventional O.P.O. driving with doors operated by train operator in leading cab.

Information sheet date: March 2007



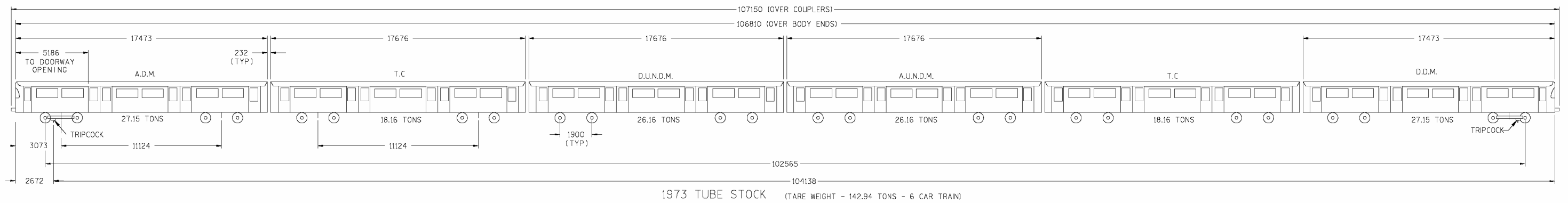

Vehicle details and statistics

	Driving Motor Car	Trailer Car	UNDM
Length over body ends:	17473mm	17676mm	17676mm
Width of body:	2629mm	2629mm	2629mm
Car height:	2888mm	2888mm	2888mm
Tare weight	29.76 tonnes	20.18 tonnes	28.53 tonnes
Double-Ender	30.22 tonnes	20.93 tonnes	-
Tare weight of 6-car train:	156.93 – 159.84 tonnes (dependent on formation)		
Passenger door open width : (double) :	1370mm	1370mm	1370mm
Passenger door open width : (single) :	685mm	685mm	685mm
Car number series:	100-253	500-696	300-453
Double-Ender	864-897		
Vehicles in stock:	194	173	152
Grand total in stock		519	

Passenger accommodation:

Please note that standing capacity figures exclude seating capacity

Seating capacity: (Number of seats per train) 228

Standing capacities: Floor area available for standing passengers (m²)^a 114

Maximum observed standing capacity (5 customers per m²) 570

Maximum full load standing capacity (6 customers per m²)^b 684

Theoretical crush standing capacity (7 customers per m²)^c 798

NOTES:

- a) Capacities here are figures **calculated** from floor area for design purposes
- b) For propulsion performance rating
- c) For structural and braking capacity

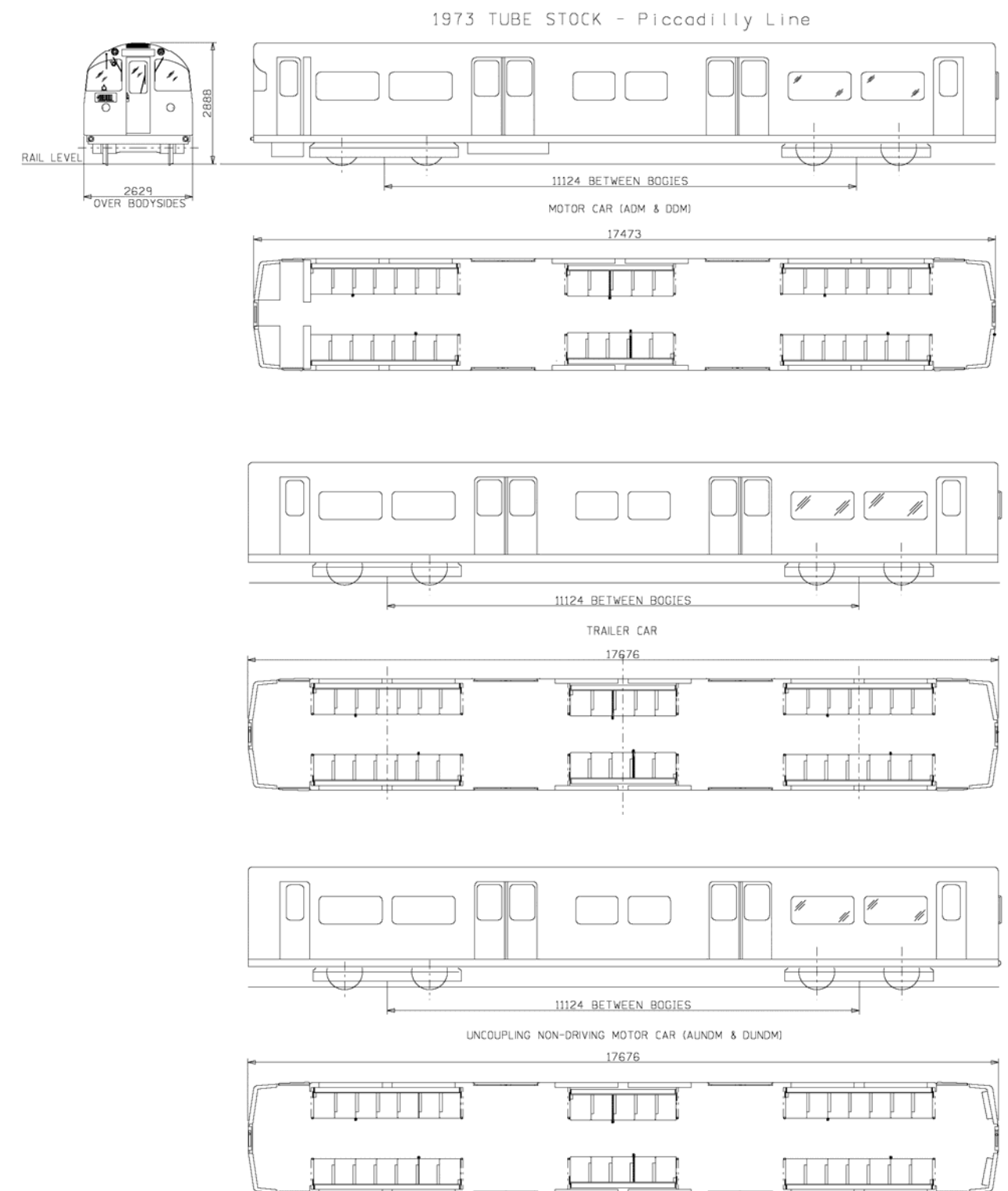

Equipment details

Bodies:	Constructed by using welded aluminium extrusions. Pneumatically-operated sliding doors, externally hung. Exterior painted in London Underground corporate red, white and blue livery.
Bogies:	H-frame type bogies without headstocks, for welded steel-box section, built by Kawasaki Heavy Industries, Japan. Wheel diameter 700mm.
Couplers:	London Underground Automatic Wedgelock between units, semi-permanent bar between cars within a unit.
Traction system:	Brush Traction/ABB G.T.O. thyristor, dc chopper control with all axles motor by Brush Electrical Machines type LT130, frame-mounted traction motors with 21/136 gearbox ratio.
Compressors:	Westinghouse Type V.R.S.20 (reciprocating).
Brakes:	Fully blended dynamic regenerative rheostatic and E.P. brake with slip/slide protection. Automatic controlled spring applied, air-released parking brakes.
Auxiliary power supplies:	A.B.B./Brush Electrical Machines static converter, one per 2-car unit.
Main lighting:	Fluorescent tubes fed by inverters from 50V dc – 26 per car
Emergency lighting:	As main lighting, but remains lit when line supply fails. 4 fluorescent tubes per DM, 6 per NDM (additional to main lighting).



1992 Tube Stocks

Central line



Built by ABB Transportation, Derby 1991-1994
Entered service Central line 1993-1995
Maintained by: Metronet Rail BCV

Principal characteristics

Track gauge:	4ft 8½ ins/1435mm
Current system:	630V dc 3 rd and 4 th rail, floating earth
Types of vehicle:	Driving Motor (DM) – car type 'A' Non-Driving Motor (NDM) – car types 'B' or 'C' De-icing Non-Driving Motor (NDM) – car type 'D'
Formation per unit:	Two cars, formed A-B, B-C or B-D
Formation per train:	Eight cars, in any one of 36 combinations of A-B, B-C and B-D two car units, with 'A' type car always at outer ends.
Number of train:	85 eight-car trains.
Operation:	Fully Automatic (A.T.O.). Non-automatic driving (coded manual (A.T.P.)). Emergency driving (slow manual) Doors operated by the train operator in leading cab. One person operated.

Information sheet date: March 2007



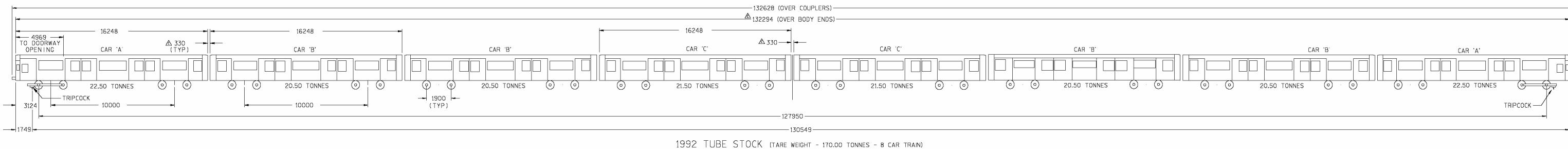

1992 TUBE STOCK (TARE WEIGHT - 170.00 TONNES - 8 CAR TRAIN)

Vehicle details and statistics

	DM Car 'A'	NDM 'B'	NDM 'C'/'D'
Length over body ends:	16248mm	16248mm	16248mm
Width of body:	2620mm	2620mm	2620mm
Car height:	2869mm	2869mm	2869mm
Tare weight	22.5 tonnes	20.5 tonnes	21.5 tonnes
Tare weight of 8-car train:		170.0 tonnes	
Passenger door open width (double) :	1664mm	1664mm	1664mm
Passenger door open width (single) :	832mm	832mm	832mm
Car number series:	AB Units	B: 920001-92349 (odd numbers)	-
		B: 920002 - 92266 (even numbers)	C: 93002-93266 (even numbers)
	BC Units	B: 92402-92464 (even numbers)	D: 93402-93464 (even numbers)
	BD Units		
Vehicles in stock:	175	340	165
Grand total in stock		680	

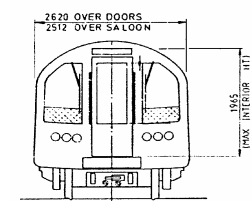

1992 TUBE STOCK - Central Line

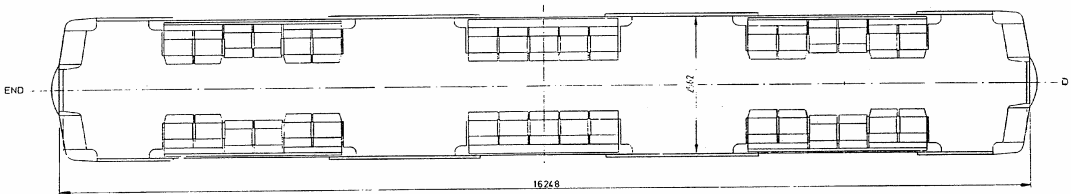
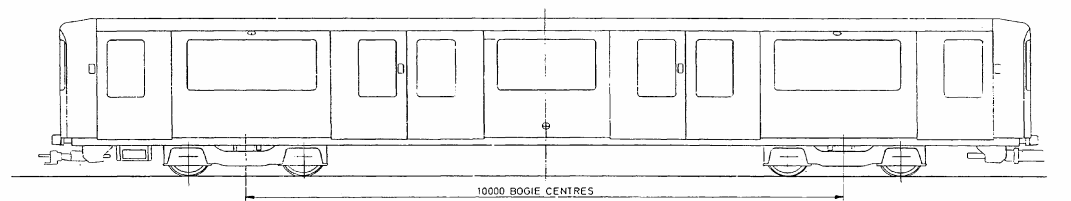
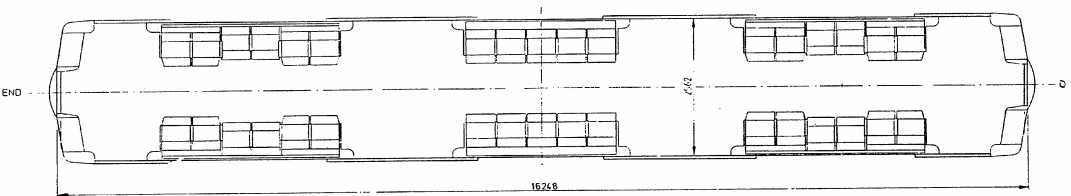
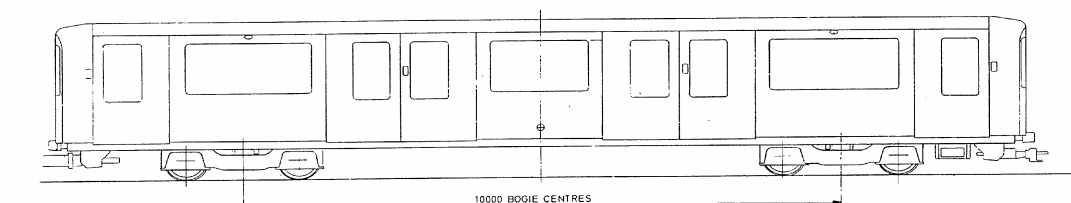
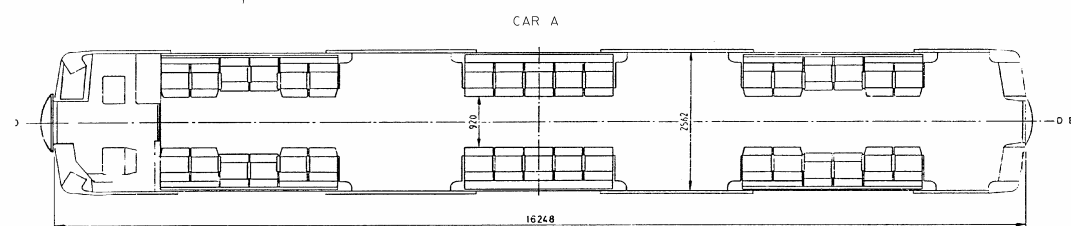
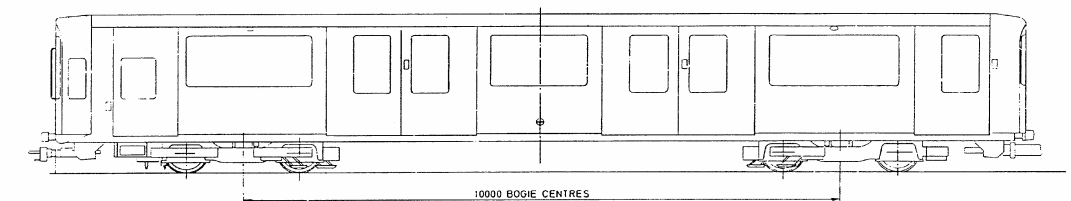

Passenger accommodation:

Please note that standing capacity figures exclude seating capacity

Seating capacity: (Number of seats per train) 272

Standing capacities: Floor area available for standing passengers (m²)^a 155.02

Maximum observed standing capacity (5 customers per m²) 775

Maximum full load standing capacity (6 customers per m²)^b 930

Theoretical crush standing capacity (7 customers per m²)^c 1085

NOTES:

- Capacities here are figures **calculated** from floor area for design purposes
- For propulsion performance rating
- For structural and braking capacity

Equipment details

Bodies:	Constructed by using welded aluminium extrusions. Pneumatically-operated sliding doors, externally hung. Exterior painted in Network South East livery.
Bogies:	H-frame type bogies without headstocks, for welded steel-box section, built by Kawasaki Heavy Industries, Japan. Wheel diameter 700mm.
Couplers:	London Underground Automatic Wedgelock between units, semi-permanent bar between cars within a unit.
Traction system:	Brush Traction/ABB G.T.O. thyristor, dc chopper control with all axles motor by Brush Electrical Machines type LT130, frame-mounted traction motors with 21/136 gearbox ratio.
Compressors:	Westinghouse Type V.R.S.20 (reciprocating).
Brakes:	Fully blended dynamic regenerative rheostatic and e.p. brake with slip/slide protection. Automatic controlled spring applied, air-released parking brakes.
Auxiliary power supplies:	A.B.B./Brush Electrical Machines static converter, one per 2-car unit.
Main lighting:	Fluorescent tubes fed by inverters from 50V dc – 26 per car
Emergency lighting:	As main lighting, but remains lit when line supply fails. 4 Fluorescent tubes per DM, 6 per NDM (additional to main lighting).



1992 Tube Stocks

Waterloo & City line



Built by ABB Transportation, Derby 1991-1994
Entered service Waterloo & City line 1993 (classified as Class 482 rolling stock)
Refurbished by: Bombardier Transportation UK, Derby 2006.
Maintained by: Metronet Rail BCV Ltd

Principal characteristics

Track gauge:	4ft 8½ ins/1435mm
Current system:	630V dc 3 rd and 4 th rail (earth return through 4 th rail)
Types of vehicle:	Driving Motor (DM) – car type 'E' Non-Driving Motor (NDM) – car type 'F'
Formation per unit:	Two cars formed E-F.
Formation per train:	Four cars formed E – F + F – E
Number of train:	5 Four-car trains.
Operation:	Non-automatic driving (tripcock). Capable of conversion to A.T.P./A.T.O. Emergency driving (slow manual) Doors operated by train operator in leading cab. One person operated.

Information sheet date: March 2007



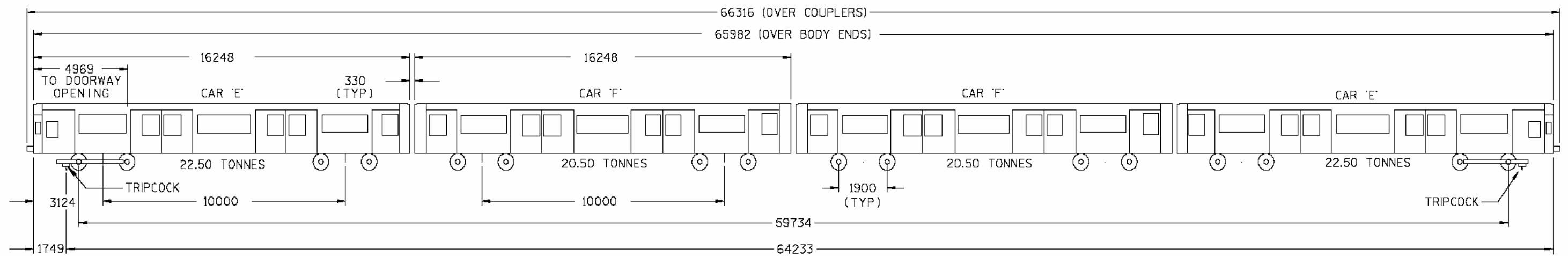

Vehicle details and statistics

	DM Car 'E'	NDM 'F'
Length over body ends:	16248mm	16248mm
Width of body:	2620mm	2620mm
Car height:	2869mm	2869mm
Tare weight	22.5 tonnes	21.5 tonnes
Tare weight of 4-car train:	86.0 tonnes	
Passenger door open width (double) :	1664mm	1664mm
Passenger door open width (single) :	832mm	832mm
Car number series:	EF Units A: 65501-65510	F: 67501-67510
Vehicles in stock:	10	10
Grand total in stock	20	

Passenger accommodation:

Please note that standing capacity figures exclude seating capacity

Seating capacity: (Number of seats per train)	136
Standing capacities: Floor area available for standing passengers (m ²) ^a	74.04
Maximum observed standing capacity (5 customers per m ²)	370
Maximum full load standing capacity (6 customers per m ²) ^b	444
Theoretical crush standing capacity (7 customers per m ²) ^c	518

NOTES:

- Capacities here are figures **calculated** from floor area for design purposes
- For propulsion performance rating
- For structural and braking capacity

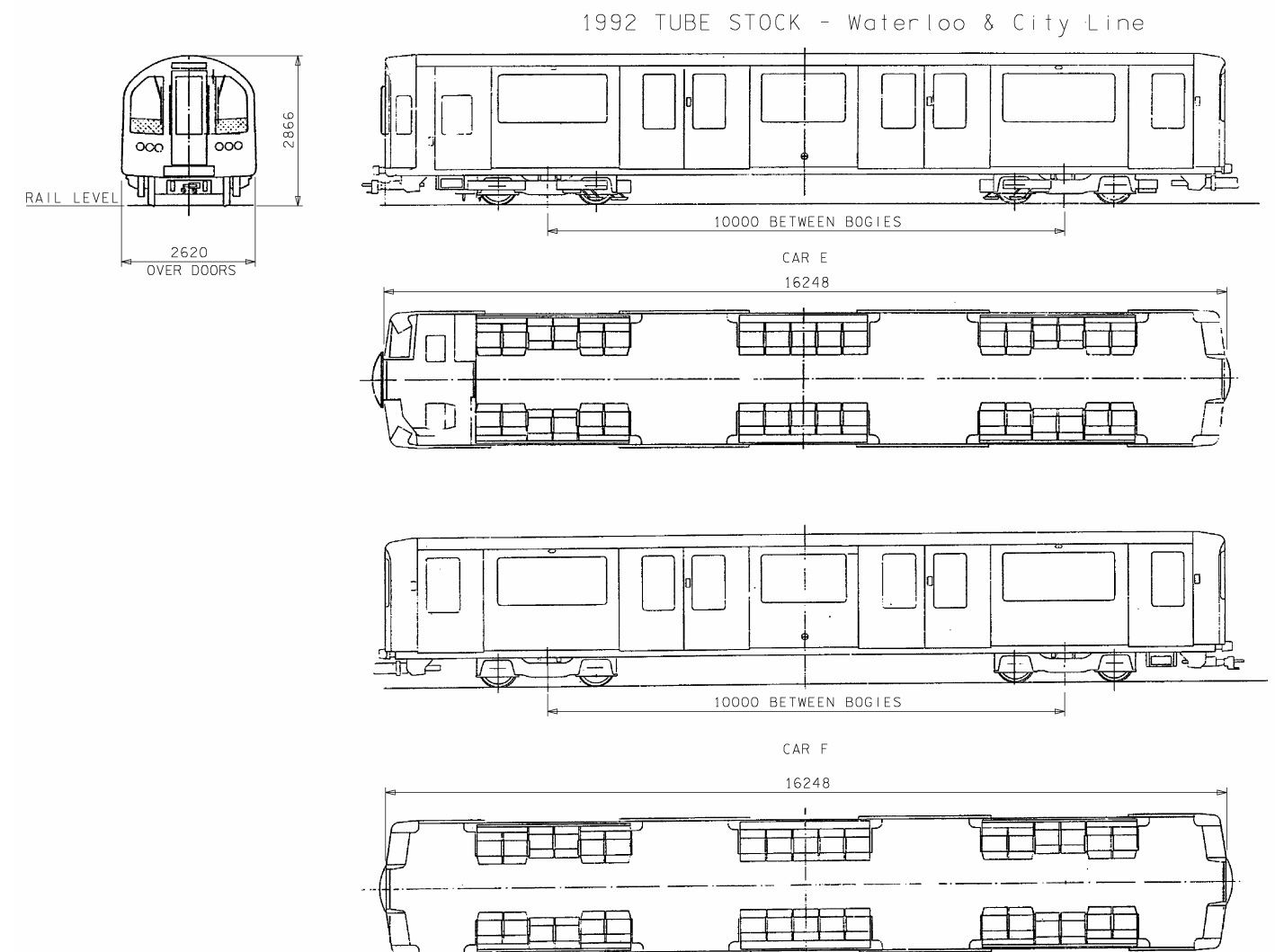

Equipment details

Bodies:	Body shell of welded aluminium extrusions. Exterior painted in London Underground corporate red, white and blue livery.
Bogies:	Twin-transom flexible frame bogies without headstocks. Frame constructed from steel plate sections and steel castings, built by ADtranz. Rubber chevron primary and secondary suspension. Wheel diameter 770mm (new).
Couplers:	London Underground Automatic Wedglock between units, semi-permanent bar between cars within a unit.
Traction system:	Alstom Onyx 3 phase AC drive using IGBT technology providing variable voltage and frequency supplies to four frame mounted 3-phase induction motors per motor car, each driving and individual axle through a flexible coupling and double reduction gearbox.
Compressors:	Westinghouse RCS rotary screw compressor driven by integral electric motor.
Brakes	Fully blended regenerative/rheostatic and e.p. friction tread brake with load control and slip/slide protection. Independent control circuits for emergency brake (energise to release) and service brakes (energise to apply). Spring applied, air released parking brake. One block per wheel, all wheels.
Auxiliary power supplies:	One IGBT auxiliary converter per unit. Provides 3-phase 415V, 50Hz to supply 3-phase and 240V single phase equipment and 52V dc for battery charging and control circuits.
Main lighting:	Fluorescent tubes fed by inverters from 50V dc – 26 tubes per motor car, 28 per trailer car and UNDM car.
Emergency lighting:	Four fluorescent tubes per car fed from a 52V battery and normally forming part of the main salon lighting.
Ventilation:	Electric heating and forced ventilation system with six ventilation fans per car, three of which have d.c. brushless motors fed from the 52V battery. Operators cab air conditioned.
Passenger Information:	Six automated LED scrolling visual display units per car. Automated audio station announcements and driver operable Public Address. Passenger alarm with talkback to driver.
Doors:	Pneumatically operated sliding doors, externally hung. Two double and one single per side (DM cars), two double and two single per side (trailers and UNDM cars)



1995 Tube Stocks

Northern line



Built by Alstom Transportation 1996-1999

Entered service Northern line 1997-2000

Maintained by: Alstom under a PFI agreement under contract to Tube Lines.

Principal characteristics

Track gauge:	4ft 8½ ins/1435mm
Current system:	630V dc 3 rd and 4 th rail, floating earth.
Types of vehicle:	Driving Motor (DM) Trailer (T) Uncoupling Non-Driving Motor Car (UNDM)
Formation per unit:	Three cars, formed DM – T - UNDM
Formation per train:	Six cars formed DM – T – UNDM + UNDM – T - DM
Number of train:	106 six-car trains.
Operation:	Conventional O.P.O driving with doors operated by Train Operator in leading cab.

Information sheet date: March 2007



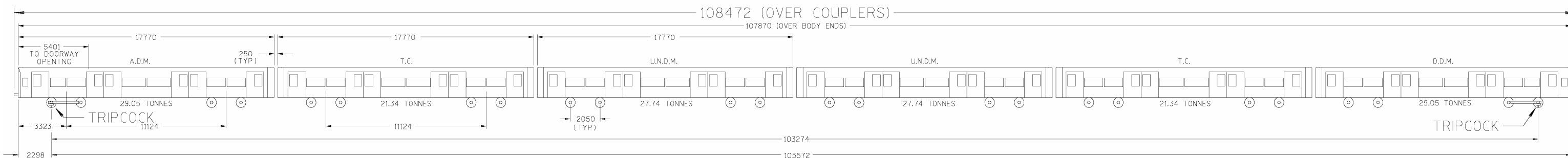

1995 TUBE STOCK - TARE WEIGHT - 156.66 TONNES - 6 CAR TRAIN

Vehicle details and statistics			
	Driving Motor Car	Trailer Car	UNDM
Length over body ends:	17770mm	17770mm	17770mm
Width of body:	2630mm	2630mm	2630mm
Car height:	2875mm	2875mm	2875mm
Tare weight	29.4 tonnes	21.5 tonnes	27.9 tonnes
Tare weight of 7-car train:		157.6 tonnes	
Passenger door open width: double:	1406mm	1406mm	1406mm
:single:	703mm	703mm	703mm
Car number series:	51501-51686	52501-52686	53501-53686
De-icing units:	51701-51726	52701-52726	53701-53726
Vehicles in stock:	212	212	212
Grand total in stock		636	

Passenger accommodation:

Please note that standing capacity figures exclude seating capacity

Seating capacity: (Number of seats per train)	248
Standing capacities: Floor area available for standing passengers (m ²) ^a	110.36
Maximum observed standing capacity (5 customers per m ²)	552
Maximum full load standing capacity (6 customers per m ²) ^b	662
Theoretical crush standing capacity (7 customers per m ²) ^c	773

- NOTES:**
- a) Capacities here are figures **calculated** from floor area for design purposes
 - b) For propulsion performance rating
 - c) For structural and braking capacity

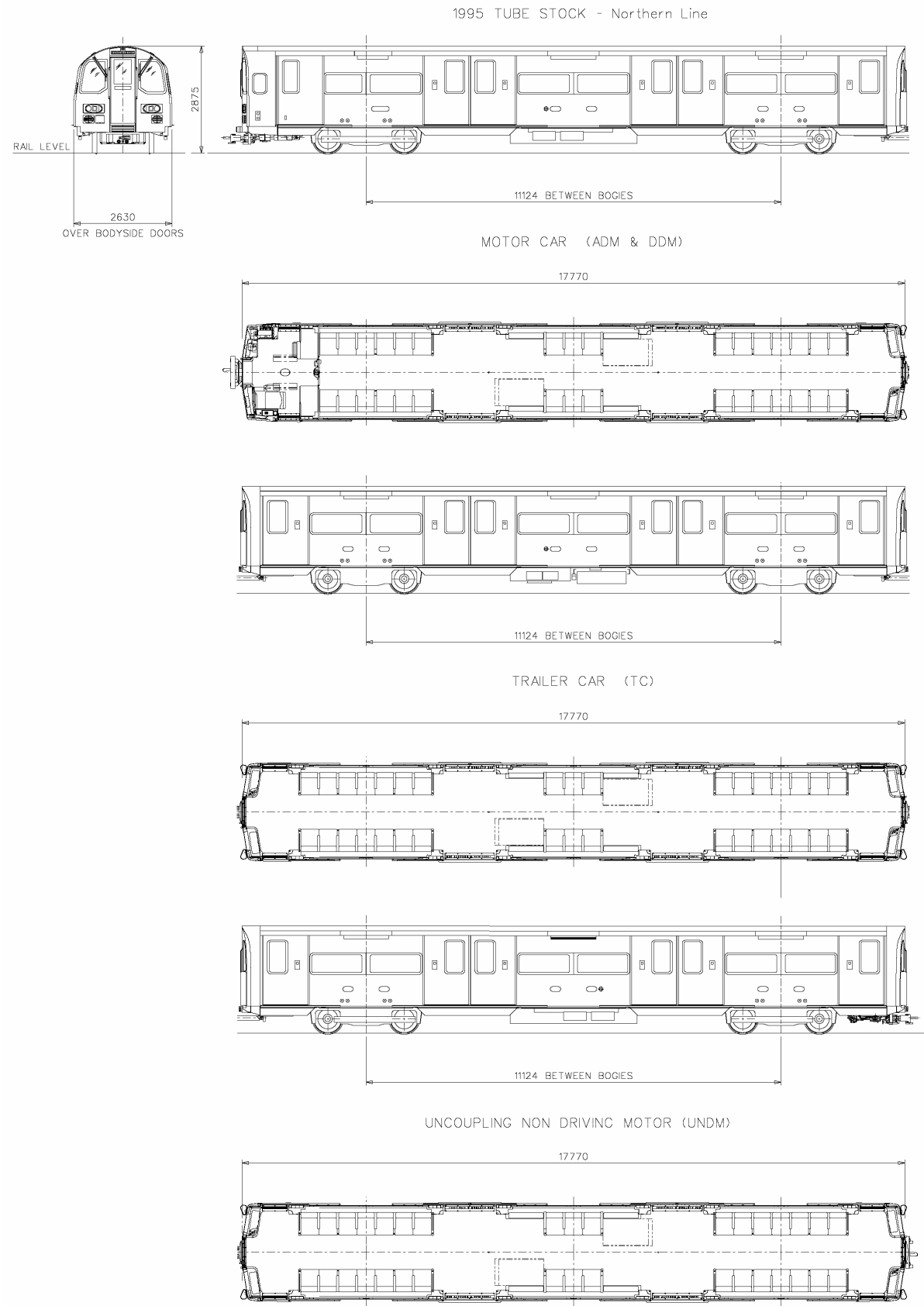

Equipment details

Bodies:	Constructed using welded aluminium extrusions. Exteriors painted in London Underground corporate red, white and blue livery. Interiors are finished in a turquoise, purple and ivory colour scheme with yellow grab poles.
Bogies:	Two axle, H-frame bogies without headstocks, of welded steel box-section, built by Alstom ACR, France. Rubber chevron primary and rubber Diablo secondary suspension. Wheel diameter 770mm (new). Flange lubrication is provided by a bogie mounted, solid stick sprung against the wheel flange.
Couplers:	Automatic Wedglock between units, semi-permanent bar between cars within a unit.
Traction system:	Four frame mounted, 3-phase induction motors per car, each driving an individual axle through a flexible coupling and double reduction gearbox. All four motors per car are fed from a single voltage-source inverter using GTO thyristor devices, derived from those used on Class 465 Networked trains
Compressors:	Westinghouse HRS reciprocating compressor driven by integral 630V dc electric motor.
Brakes	Fully blended regenerative/rheostatic and e.p. friction tread brake with load control and slip/slide protection. One tread brake block per wheel. Independent control circuits for emergency brake (energise to release) and service brakes (energise to apply). Automatic spring applied, air released parking brake. One block per wheel, all wheels.
Auxiliary power supplies:	One IGBT auxiliary converter per unit, configured as a GTO thyristor step-down chopper feeding an IGBT inverter. Provides 3-phase 415V, 50Hz to supply 3-phase and 240V single phase equipment and 52V dc for battery charging and control circuits.
Main lighting:	230V ac fluorescent tubes individually fed by inverter from 50V dc – 26 tubes per motor car, 28 per trailer car and UNDM car.
Emergency lighting:	Four fluorescent tubes per car fed from a 52V battery and normally forming part of the main salon lighting.
Ventilation:	Electric heating and forced ventilation system with six ventilation fans per car, three of which have d.c. brushless motors fed from the 52V battery. Operators cab air conditioned.
Passenger Information:	Six automated LED scrolling visual display units per car. Automated audio station announcements and driver operable Public Address. Passenger alarm with talkback to driver.
Doors:	Pneumatically operated sliding doors, externally hung. Two double and one single per side (DM cars), two double and two single per side (trailers and UNDM cars)



1996 Tube Stocks

Jubilee line



Built by Alstom Transportation 1995-1998 and 2005-2006
Entered service Jubilee line 1997-2000 and 2005-2006
Maintained by: Alstom under contract to Tube Lines.

Principal characteristics

Track gauge:	4ft 8½ ins/1435mm
Current system:	630V dc 3 rd and 4 th rail, floating earth.
Types of vehicle:	Driving Motor (DM) Trailer (T) Uncoupling Non-Driving Motor Car (UNDM)
Formation per unit:	Three cars formed, DM – T - UNDM (west/north) Four cars formed, UNDM – T- T – DM (east/south)
Formation per train:	Seven cars formed DM – T – UNDM + UNDM – T - T - DM
Number of train:	63 seven-car trains.
Operation:	(1) Conventional one person Operation (O.P.O.) with tripcock Train Protection. (2) Designed for conversion to Automatic Train Operation (A.T.O.) or manual train operation with transmission based Automatic Train Protection (A.T.P.). (Both with doors enabled and closed by train operators in leading cab).

Information sheet date: March 2007



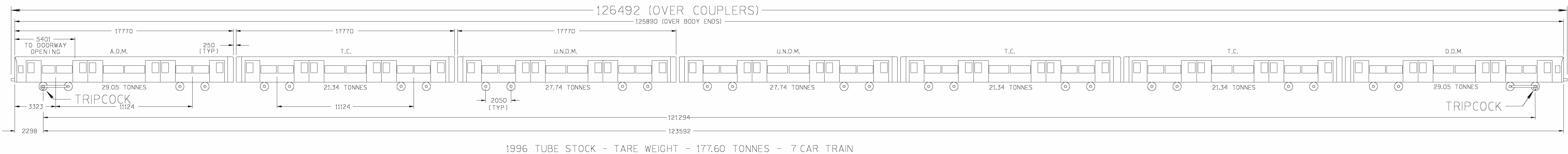

Vehicle details and statistics

	Driving Motor Car	Trailer Car	UNDM
Length over body ends:	17770mm	17770mm	17770mm
Width of body:	2629mm	2629mm	2629mm
Car height:	2875mm	2875mm	2875mm
Tare weight	30.0 tonnes	20.9 tonnes	27.1 tonnes
Tare weight of 7-car train:		176.9 tonnes	
Passenger door open width:			
double:	1406mm	1406mm	1406mm
:single:	703mm	703mm	703mm
Car number series:	96001-96126	96201-96279 96318-96326 96281-96317 (odd numbers) 96601-96725 (odd numbers) De-icing trailers: 96880-96918 (even numbers)	96401-96526
Vehicles in stock:	126	189	126
Grand total in stock		441	

Passenger accommodation:

Please note that standing capacity figures exclude seating capacity

Seating capacity: (Number of seats per train)	234
Standing capacities: Floor area available for standing passengers (m ²) ^a	145.92
Maximum observed standing capacity (5 customers per m ²)	730.0
Maximum full load standing capacity (6 customers per m ²) ^b	875.16
Theoretical crush standing capacity (7 customers per m ²) ^c	1021.41

NOTES:

- Capacities here are figures **calculated** from floor area for design purposes
- For propulsion performance rating
- For structural and braking capacity



Equipment details

Bodies:	Aluminium alloy panels, extrusions and castings, riveted together with underframes of aluminium alloy extrusions and castings with steel headstock and bolsters. Exteriors painted on refurbishment in LUL red, white and blue corporate livery.
Bogies:	4-wheel symmetrical plate frame of welded/riveted construction. Wheel diameter 3ft (915mm)
Couplers:	London Underground Automatic Wedgelock between units, semi-permanent bar between cars within a unit.
Traction system:	G.E.C. (Witton) LT114, axle-hung, nose-suspended, 300V motors, 17/74 gear ratio, 4 per motor car. 1 motor per driving axle, motors connected in permanent series pairs. AEI pneumatic camshaft resistance controller with series/parallel groupings and 2 stages of weak field.
Compressors:	Westinghouse DHC 5A reciprocating, one on each trailer car (A60 stock). Reavell TBC 38Z reciprocating, one on each trailer car (A62 stock).
Brakes:	Service braking – Westinghouse electro-pneumatic, 2 blocks per wheel, all wheels. Emergency braking – Westinghouse automatic air brake. Parking brake – automatic spring-applied air released.
Auxiliary power supplies:	1 A.E.I. Motor-Alternator-Rectifier (type MG3005) per Driving Motor car.
Main lighting:	18 fluorescent tubes per car, 15 of which are fed by 115V, 850Hz supply from MA.
Emergency lighting:	3 of the main lighting tubes per car are fed from a 50V battery via one inverter per tube.
Doors:	Two double and one single (Driving Motors), three double (Trailers) per side.



A60 & A62 Stock

Metropolitan and East London lines



Built by Cravens, Sheffield 1960-1963

Entered service Metropolitan line 1961-1963

Four-car trains on East London line 1977-1985 and from 1987

Refurbished by ADtranz Ltd., Derby 1994-1997

Maintained by: Metronet Rail SSL Ltd

Principal characteristics

Track gauge:	4ft 8½ ins/1435mm
Current system:	630V dc 3 rd and 4 th rail, floating earth
Types of vehicle:	Driving Motor (DM) Trailer (T)
Formation per unit:	Four cars, formed DM – T – T – DM
Formation per train:	Four cars, formed DM – T – T – DM (Chesham shuttle and East London line) Eight cars, formed DM – T – T – DM + DM – T – T – DM
Number of train:	56½ eight-car
Operation:	Conventional O.P.O. driving with doors operated by train operator in leading cab. (Some cabs have not been converted to O.P.O. and have been down-graded to 'Middle Motor' status. These cabs can still be used for shunting in depots.)

Information sheet date: March 2007



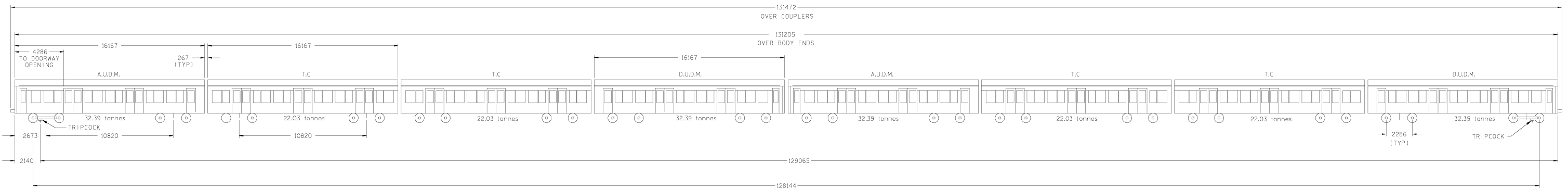

Vehicle details and statistics

	Driving Motor Car	Trailer Car
Length over body ends:	16167mm	16167mm
Width of body:	2946mm	2946mm
Car height:	3689mm	3689mm
Tare weight	31.9 tons	21.7 tons
Tare weight of 8-car train:	214.24 tons	
Passenger door open width (double)	1372mm	1372mm
(single)	686mm	-
Car number series:	A60 5000-5123	6000-6123*
De-icing units:	A60 5232-5235	6232-6235
	A62 5124-5231	6124-6231
Vehicles in stock:	226	227*
Grand total in stock	453	

*one car (6036) converted to Rail Adhesion Car to apply Sandite to running rails as required.

Passenger accommodation:

Please note that standing capacity figures exclude seating capacity

	ELL	Met
Seating capacity: (Number of seats per train)	184	448
Standing capacities: Floor area available for standing passengers (m ²) ^a	74.66	149.32
Maximum observed standing capacity (5 customers per m ²)	373	747
Maximum full load standing capacity (6 customers per m ²) ^b	448	896
Theoretical crush standing capacity (7 customers per m ²) ^c	523	1045

- NOTES:**
- a) Capacities here are figures **calculated** from floor area for design purposes
 - b) For propulsion performance rating
 - c) For structural and braking capacity

A60/62 SURFACE STOCK - Metropolitan Line

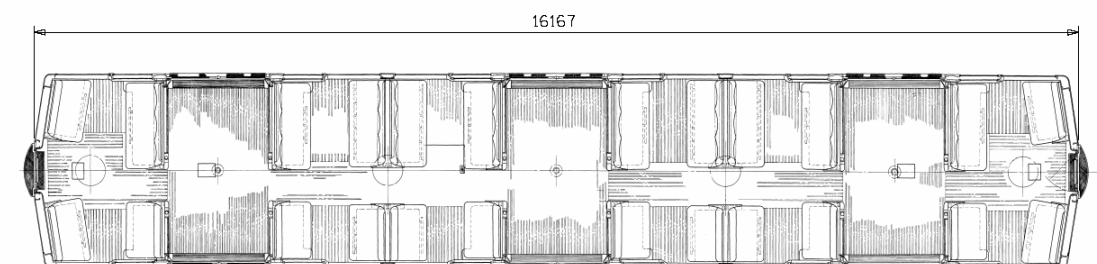
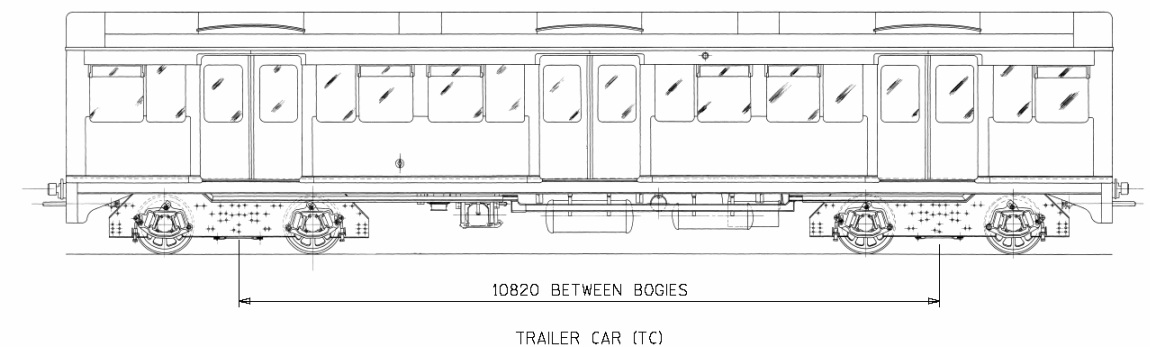
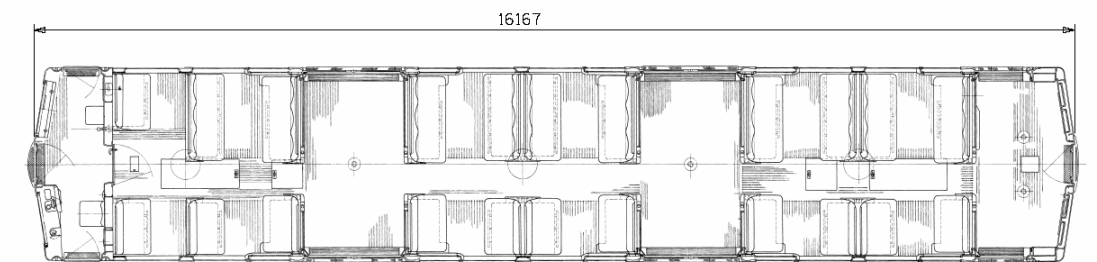
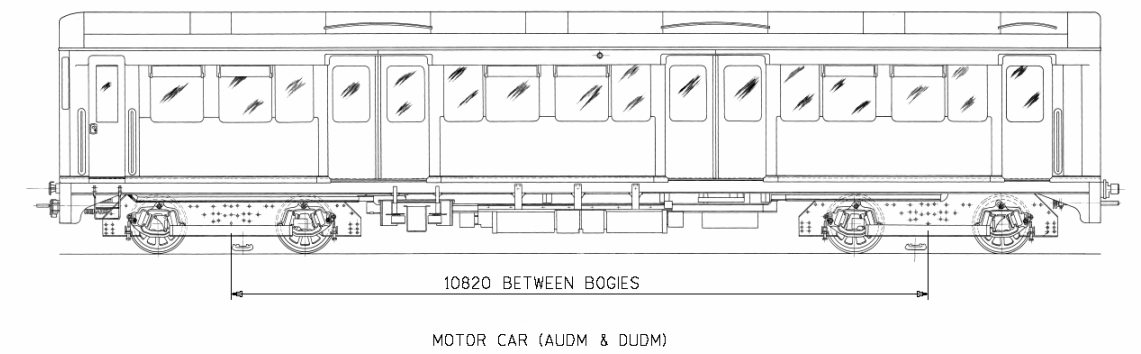
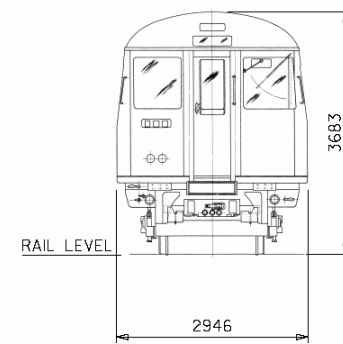

Equipment details

Bodies:	Aluminium underframe, originally unpainted aluminium alloy panelling - exteriors painted on refurbishment in LUL red, white and blue corporate livery.
Bogies:	4-wheel symmetrical plate frame bogies of welded/riveted construction. Wheel diameter 3ft (915mm).
Couplers:	London Underground Automatic Wedgelock between units, semi-permanent tray between cars within a unit.
Traction system:	English Electric – A.E.I. Traction Ltd. (C69) or G.E.C. Traction (C77), pneumatic double camshaft, resistance controller with series/parallel grouping and 2 stages of weak field. Brush LT117 axle-hung, nose-suspended motors, 17/114 gear ratio, 4 per driving motors car, 1 per driving axle, the two motors on each bogie are connected in permanent series.
Compressors:	Reavell TBC 38Z (some C69 and all C77) or Westinghouse 3HC43 (some C69), reciprocating, one on each trailer car.
Brakes:	Rheostatic on Driving Motors, one pneumatically-operated brake block per wheel on all cars. Service braking – electro-pneumatic with rheostatic on motor cars; electro-pneumatic only on trailer cars. Emergency braking – Westinghouse automatic air brake. Parking brake – Automatic spring applied, air released.
Auxiliary power supplies:	English Electric - A.E.I. Traction Ltd (C69) or G.E.C. Traction (C77) Motor-Alternator-Rectifier (type MG3005), one per Driving Motor car.
Main lighting:	Inverter driven, 115V ac Fluorescent tubes, 16 per car.
Emergency lighting:	2 inverter-fed, 50V dc powered, fluorescent tubes per car.
Doors:	4 double sliding per car, per side.



C69 & C77 Stock

Circle, Hammersmith & City line and District line (Edgware Road-Wimbledon/Olympia)



Built by Metro-Cammell, Birmingham 1969-1971 (C69) and 1977-1978 (C77)
Entered service Hammersmith & City and Circle line 1970-1971 (C69) and 1977-1979 (C77)
Commenced operation on the District line from April 1978
Refurbished by RFS Industries, Doncaster 1991-1994
Maintained by: Metronet Rail SSL Ltd

Principal characteristics

Track gauge:	4ft 8½ ins/1435mm
Current system:	630V dc 3 rd and 4 th rail, floating earth
Types of vehicle:	Driving Motor (DM); Trailer (T)
Formation per unit:	Two cars, formed DM – T
Formation per train:	Six cars, formed DM – T + T – DM + T – DM or DM – T + DM – T + T – DM
Number of train:	35 six-car trains (C69 stock) and 11 six-car trains (C77 stock)
Operation:	Conventional O.P.O. driving with doors operated by train operator in leading cab. Both C69 and C77 stock trains are compatible and are able to operate together in service. Following refurbishment there is no visible distinction between the two types.

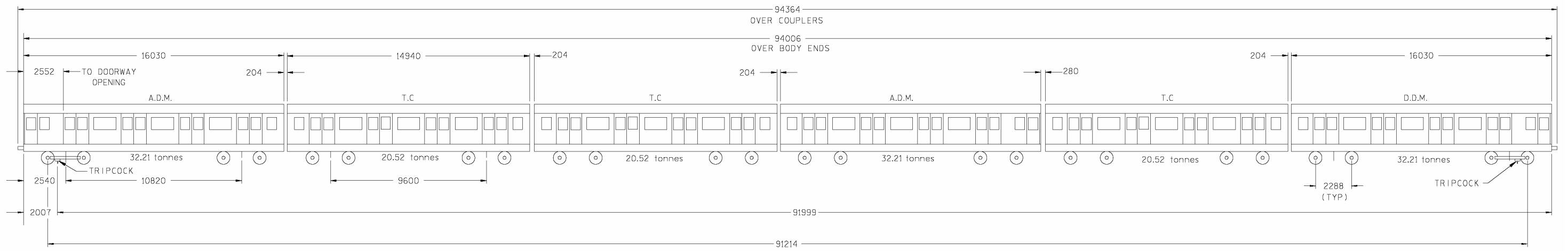

C69/77 SURFACE STOCK - TARE WEIGHT - 158.19 tonnes - 6 CAR TRAIN

Vehicle details and statistics

	Driving Motor Car	Trailer Car
Length over body ends:	52ft 7ins	49ft 0ins
Width of body:	9ft 7ins	9ft 7ins
Car height:	12ft 1in	12ft 1in
Tare weight	31.7 tons	20.2 tons
Tare weight of 8-car train:	155.70 tons	
Passenger door open width (double)	4ft 6ins	4ft 6ins
Car number series:	C69	5501-5605
	C77	5701-5733
Vehicles in stock:	138	138
Grand total in stock	276	
*Trailers 6543 to 6556 were originally de-icing units, 6554 to 6556 have since been decommissioned.		

Passenger accommodation:

Please note that standing capacity figures exclude seating capacity

Seating capacity: (Number of seats per train)	198
Standing capacities: Floor area available for standing passengers (m ²) ^a	136.89
Maximum observed standing capacity (5 customers per m ²)	684
Maximum full load standing capacity (6 customers per m ²) ^b	821
Theoretical crush standing capacity (7 customers per m ²) ^c	958

NOTES:

- Capacities here are figures **calculated** from floor area for design purposes
- For propulsion performance rating
- For structural and braking capacity

C69/77 SURFACE STOCK - Hammersmith & City Lines



Equipment details

Bodies:	Aluminium underframe, riveted aluminium body frame. Unpainted aluminium alloy panelling pre-refurbishment, exteriors painted on refurbishment in LUL red, white and blue corporate livery.
Bogies:	Flexible H-frame type bogies without headstocks of welded steel-box section with rubber joints to accommodate track twist. Wheel diameter 790mm new, 710 worn.
Couplers:	London Underground Automatic Wedglock between units, semi-permanent bar between cars within a unit.
Traction system:	G.E.C. Traction pneumatic single camshaft, resistance controller with series/parallel grouping and 2 stages of weak field. Brush LT118 axle-hung, nose-suspended motors, 17/75 gear ratio, 4 per driving motor car, 1 per driving axle, the two motors on each bogie are connected in permanent series.
Compressors:	Westinghouse 3HC43, reciprocating with integral 630V dc motor, 1 on single-ended trailer cars, 2 on double-ended units.
Brakes:	Service brake: Motor – blended rheostatic/friction brake with load control. Trailer cars – friction brake with load control. Friction brake – one brake block per wheel. Emergency brake: All cars – Friction brake. Brake control: via energise to release Westcode 7-step valve. Steps 3/7, 4/7, 5/7, 6/7 for service, step 7/7 for emergency. Service brake: Energise to apply 3-wire control system. Parking brake: automatic spring applied, air released.
Auxiliary power supplies:	One G.E.C. Traction Motor- Alternator-Rectifier (type MA3007), one per DM and UNDM car. One Mawdsley type 7CA Motor-Alternator-Rectifier per trailer car for supplying 240V ac extractor fans.
Main lighting:	115V ac Fluorescent tubes, 18 per motor car, 20 per trailer/UNDM car.
Emergency lighting:	2 inverter-fed, 50V dc powered, fluorescent tubes per car.
Doors:	4 double sliding per car, per side.



D78 Stock

District line



Built by Metro-Cammell, Birmingham 1978 - 1981

Entered service District line 1979-1983

Refurbished by Bombardier Transportation UK, Derby 2004 - 2008

Maintained by: Metronet Rail SSL Ltd

Principal characteristics

Track gauge:	4ft 8½ ins/1435mm
Current system:	630V dc 3 rd and 4 th rail, floating earth
Types of vehicle:	Driving Motor (DM), Double Ender Driving Motor (DM ₂) Trailer (T), Uncoupling Non-Driving Motor (UNDM)
Formation per unit:	Three cars, formed DM – T – UNDM or DM ₂ – T – DM ₂
Formation per train:	Six cars, formed DM – T – UNDM + UNDM – T – DM DM – T – UNDM + DM ₂ – T – DM ₂ DM ₂ – T – DM ₂ + DM ₂ – T – DM ₂ DM – T – UNDM + DM ₂ – T – DM ₂
Number of train:	75 six-car trains.
Operation:	Conventional one person operation (OPO) driving with doors operated by train operator in leading cab.

Information sheet date: March 2007



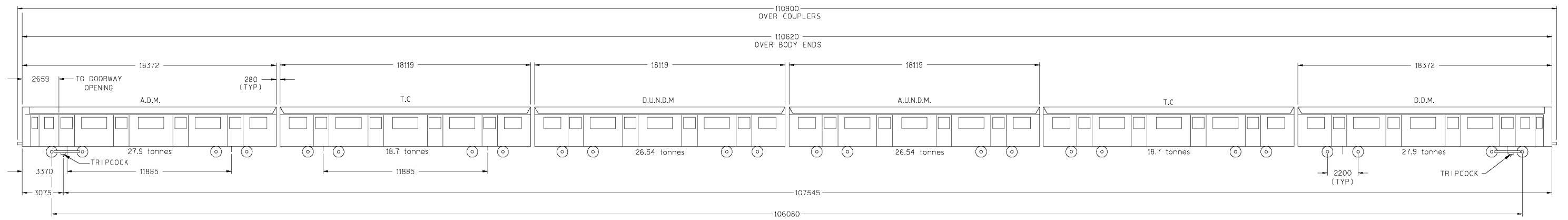

D78 SURFACE STOCK - TARE WEIGHT - 146.28 tonnes - 6 CAR TRAIN

Vehicle details and statistics

	Driving Motor Car	Trailer Car	UNDM
Length over body ends:	18372mm	18119mm	18119mm
Width of body:	2840mm	2840mm	2840mm
Car height:	3630mm	3630mm	3630mm
Tare weight	29.8 tonnes	20.2 tonnes	29.1 tonnes
Post – Refurbishment	30.7 tonnes	21.2 tonnes	29.8 tonnes
Tare weight of 6-car train:		158.2 tonnes	
Post Refurbishment		163.6 tonnes	
Passenger door open width	1127mm	1127mm	1127mm
Car number series:	7000-7129	17000-17129	8000-8129
Double-Ender	7500-7539	17500-17538	-
Vehicles in stock:	170	150	130
Grand total in stock		450	

Passenger accommodation:

Please note that standing capacity figures exclude seating capacity

Seating capacity: (Number of seats per train)	280
Standing capacities: Floor area available for standing passengers (m ²) ^a	136.91
Maximum observed standing capacity (5 customers per m ²)	685
Maximum full load standing capacity (6 customers per m ²) ^b	821
Theoretical crush standing capacity (7 customers per m ²) ^c	958

NOTES:

- Capacities here are figures **calculated** from floor area for design purposes
- For propulsion performance rating
- For structural and braking capacity

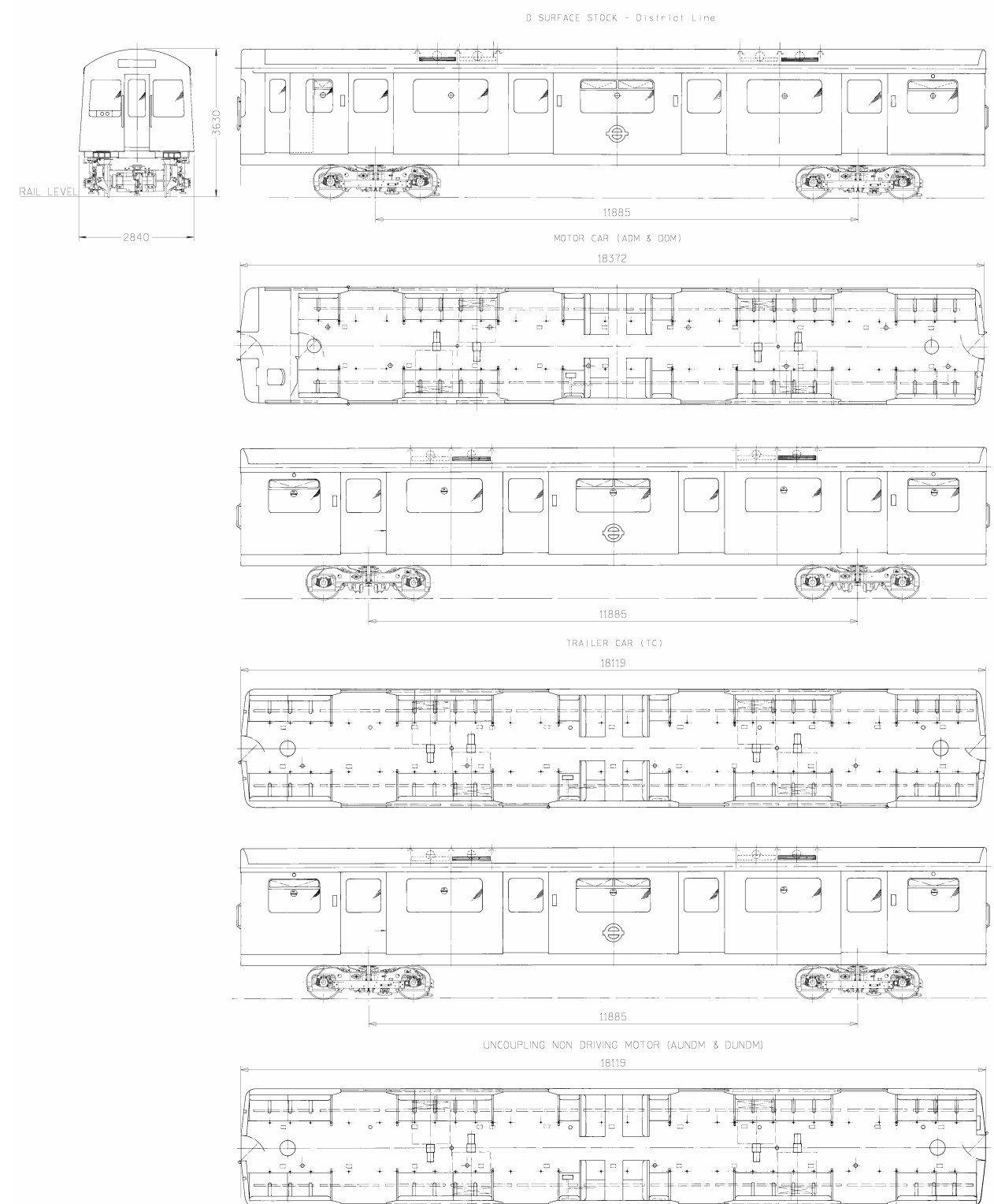

Engineers' Rolling Stock

All information taken from Transplant Drawings

The following are just seven examples of engineering rolling stock in use across the LU network



Type: Track Recording Train
 In service between: Converted 1987
 Key characteristics: Pilot cars L132/L133 Ex-1960 Cravens Stock
 Track Recording Car Ex-1973 Metro-Cammell Stock
 Train Length: 50.7m (approx)
 Train weight: 87.8 Tonnes
 Max speed: 60mph
 Equipment summary: Air braked
 Wedgelock couplers
 Onboard computers and instrumentation to produce data travelling at normal line speed. Analogue data is plotted on chart recorders. Statistical and defect reports are generated from plotters, recorders store data for off line analysis. Paint is sprayed on the track if certain faults are detected.



Type: Spoil and Ballast Wagon (ex BR Turbot) – Fleet of 60
 In service between: January/February 1996
 Key characteristics: Length: 16332mm – over extended buffers
 Tare weight: 14 Tonnes
 Gross weight: 48 Tonnes
 Payload capacity: 34 Tonnes
 Equipment summary: Two pipe distributor air brake system
 Control wiring to allow remote control of rear locomotive
 Drophead Buckeye couplers with conventional drawhooks and buffer for emergency use.



Type: Schoma CFL500VR Diesel Locomotive – Fleet of 14
 In service between: February 1996
 Key characteristics: Weight: 33.88 Tonnes
 Length: 8500mm over buffers
 Gauge: LU Tube Profile
 Max speed: 50km/h
 Primary power 6 cylinder, inline diesel engine
 500Horse Power (380kw)
 Direct and Automatic Braking
 Equipment summary: Two pipe distributor air brake system
 Retractable buffers
 Drophead Buckeye couplers with conventional drawhook and buffers for emergency use.



Type: Tunnel Cleaning Train
 In service between: Converted 1978
 Key characteristics: TCC1/TCC5 Driving motor cars Ex-1938 stock
 TCC2, TCC3, TCC4 – Constructed 1972-1977 LUL Ltd.
 Train weight: 173 Tonnes (Gross)
 Service speed: 0.8-10 km/h
 Max speed: 48km/h
 Equipment summary: Air Braked
 Wedgelock couplers
 Standard electric PCM drive to move to and from site
 Electro-hydraulic drive for constant low speed during cleaning
 Sucking fans and inlets to remove dirt
 Filtration units
 Dirt discharge units
 Heavy refuse compartments
 Blowing fans and nozzles to disturb dirt



Type: Plasser PU 07-16 Tamping and Lining Machine – Fleet of 3
 In service between: 1980
 Key characteristics: Length 19600mm – over extended buffers
 Gross weight: 40 Tonnes
 'Deutz' air cooled Diesel engine
 Equipment summary: Air braked
 Buckeye couplers



Type: Battery Locomotive – Fleet of 37
 In service between: 1964, 1970, 1974
 Key characteristics: Length 16962mm over extended buffers
 Weight: 62 Tonnes approx
 Max speed 48km/h
 Equipment summary: Able to run on normal traction supply or from 320V dc traction battery
 Normally runs to and from site on traction power and on-site using batteries
 Two pipe distributor air brake system
 Drophead Buckeye couplers with conventional drawhooks and buffers for emergency use. Emergency Wedgelock coupler.
 320V DC 15A Socket on cab back for cement mixers.
 White box (10 pin socket) control jumper for long welded rail train lights and communication.
 320V DC (3 pin socket) for wagon mounted compressors and concrete breaker.



Type: General Purpose Wagon – Fleet of 56
 In service between: 1985 (Jubilee Line Extension Fleet built 1994)
 41- 1985, 15 -1994)
 Key characteristics: Length: 16332mm over extended buffers
 Tare Weight: 19 Tonnes
 Gross Weight: 49 Tonnes
 Payload capacity: 30 Tonnes/19.5 Cubic Metres
 Equipment summary: Two pipe distributor air brake system
 Drophead Buckeye couplers with conventional drawhooks and buffers for emergency use.
 Automatic empty/load valve
 Retractable buffers Buckeye/RCH
 One motor per bogie on motor cars
 Five motor cars per seven car train

Passenger Rolling Stock

Through the ages

The following are just a few examples that illustrate the evolution of London Underground Rolling Stock through the ages



Type: City and South London Railway Locomotive
 In service between: 1890-1923
 Key characteristics: 2 axle locomotive, 43 built
 Equipment summary: Originally axle mounted direct drive
 Air brakes with air reservoirs charged at terminus
 Gear drive motors and compressors fitted in 1907



Type: City and South London Railway Passenger Car
 In service between: 1890-1923
 Key characteristics: Known as 'padded cells' due to the very small windows
 Seats for 35 passengers
 Entrance and Exit platforms with lattice gates supported on bogies of adjacent cars
 Equipment summary: Lighting directly from 500v dc traction supply



Type: City and South London Railway Motor Coach
 In service between: 1903-1939
 Key characteristics: All steel underframe and Switch-gear compartment.
 Wooden body. 42 seats Lattice gates at each end for entrance and exit. Ran as six car train or three car train with control trailer at one end
 Equipment summary: Air doors fitted 1926/1928. First Tube train with Tripcock and Trainstop equipment.



Type: Metropolitan Railway Electric Locomotive
 In service between: 1906-1961 (Rebuilt around 1920)
 No. 12 "Sarah Siddons" is still in operation and is used on special trains
 Key characteristics: 2 axle locomotive, 43 built
 Equipment summary: Originally axle mounted direct drive



Type: F Stock
 In service between: 1920-1963
 Key characteristics: All steel construction
 3 x double leaf sliding doors – originally hand operated
 Equipment summary: Fitted with Electro-pneumatic brakes circa 1929
 Doors converted to pneumatic operation circa 1938

Passenger Rolling Stock

Through the ages



Type: Standard Stock
 In service between: 1923-1964. Train pictured from 1931.
 Key characteristics: Individual car arrangement allowing flexible formation of cars into trains
 Equipment summary: Equipment cubicle behind driving cabs
 Air doors
 Electro-pneumatic brakes fitted during 1930's



Type: 1938 Tube Stock
 In service between: 1938-1987.
 A number of units continue to operate on the Isle of Wight
 Key characteristics: More than 1200 purchased originally. The first tube stock with all equipment under the floor. First true multiple unit train.
 Equipment summary: Underfloor 'PCM' air powered camshaft resistance controller
 One motor per bogie on motor cars
 Five motors cars per seven car train



Type: O/P Stock
 In service between: 1937-1981
 Key characteristics: All steel construction
 Two double and one single passenger doors per car
 Equipment summary: Originally fitted with 'Metadyne' rotary converters which permitted regenerative braking
 Converted to 'PCM' type controller circa 1955



Type: 1959/1962 Tube Stock
 In service between: 1959-2000
 Key characteristics: Unpainted aluminium panelling on steel frame
 Equipment summary: Underfloor 'PCM' air powered camshaft resistance controller
 One motor per bogie on motor cars
 Five motor cars per seven car train
 Fluorescent lights and rubber suspension

