



The status of the blind spot information and warning signals and the motion inhibit system shall be recorded, along with the VRU test target and VUT positions, from time T_0 to $T_1 + 3$ seconds.

The evaluation distance shall be taken as the difference between the VRU test target positions at T_0 and T_1 .

Each specified test scenario shall be undertaken once.

Should the motion inhibit function be activated, the driver may use the over-ride function to move the vehicle.

The motion inhibit over-ride function shall be applied manually through one of the following conditions:

- a) A throttle action that requires deliberate additional force similar to kick-down actions or other defined sequence of inputs not typical of normal driving
- b) A button that is held down for at least 3 seconds
- c) A switch, series of switches or menu-based screen interface, where at least 3 discrete actions are required

A collision warning signal shall be issued whilst the motion inhibit over-ride function is applied.

With the motion inhibit over-ride function applied, the VUT shall be driven away from the test target to a finish point no further than 10 m away where no further hazards are present.

The motion inhibit over-ride function shall deactivate before either reaching the finish point or 10 seconds after activation, whichever is a greater time period.

8.2 Bus in motion Scenarios

8.2.1 General Test Scenario Configuration

The general test scenario configuration is designed to be representative of collisions with VRUs in an urban area. Two categories of test scenario are assessed: the first where a bicyclist cycles alongside the nearside of a bus driving forward or performing a nearside turn and the second where a pedestrian crosses the road on the nearside of a bus whilst driving forward or performing a nearside turn.

Representative VUT and VRU test target starting positions and intended motions are illustrated in Figure 24_7, alongside positioning information for the standardised environmental clutter.

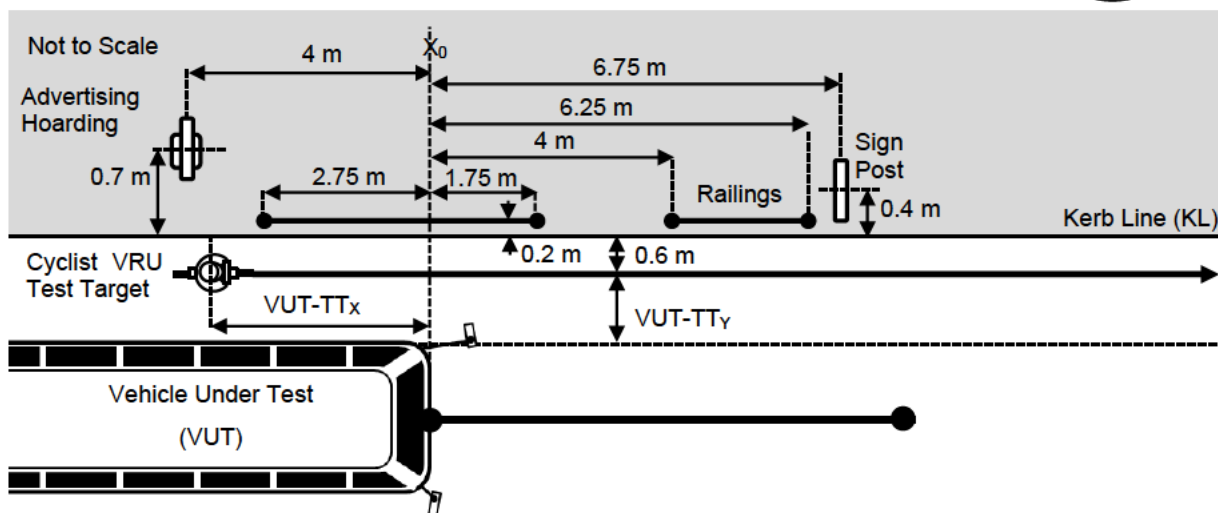

Figure 24_7: General test configuration for vehicle under test (VUT), test target (VRU) and standardised environmental clutter positions at time T_0 with intended motions for nearside turn test scenarios

All test scenario configuration dimensions illustrated in Figure 24_7 are described in greater detail below. Fixed dimensions are enumerated, whilst dimensions that vary with each test scenario are described by their acronym:

- a) Vehicle under test, length (VUT_L)
- b) Kerb Line (KL) is a line parallel to the global X-axis defining the nominal kerb edge of the road, prior to the simulated junction.
- c) Turn Point (TP) is the X-position of the foremost point of the VUT at the moment that it commences steering
- d) Longitudinal distance from AP to centreline of cyclist VRU ($VUT-TT_x$)
- e) Lateral distance from nearside of VUT to centreline of cyclist VRU ($VUT-TT_y$)
- f) Lateral distance from KL to centreline of cyclist VRU = 0.6 m
- g) Longitudinal distance from X_0 to centreline of pedestrian VRU = 8.5 m
- h) Lateral distance from nearside of VUT to centreline of cyclist VRU = 2.0 m
- i) Lateral distance from KL to centreline of cyclist VRU = 1.0 m
- j) Lateral distance from KL to centreline of railings = 0.2 m
- k) Longitudinal distance from X_0 to leading edge of foremost railing = 6.25 m
- l) Longitudinal distance from X_0 to trailing edge of foremost railing = 4.0 m
- m) Longitudinal distance from X_0 to leading edge of rearmost railing = 1.75 m
- n) Longitudinal distance from X_0 to trailing edge of rearmost railing = 2.75 m
- o) Lateral distance from KL to centreline of Advertising Hoarding = 0.7m
- p) Longitudinal distance from AP to centreline of Advertising Hoarding = 4.0 m
- q) Lateral distance from KL to centreline of signpost = 0.4 m
- r) Longitudinal distance from X_0 to centreline of signpost = 6.75



8.2.2 Cyclist Undertaking Bus Proximity Information Signal (CUPI) Scenario

This test assesses the ability of a system to detect a cyclist manoeuvring along the nearside of a bus and provide an effective VRU proximity information signal. The vehicle under test, test target and standardised environmental clutter shall be set up as specified in Section 8.2.1 with additional test scenario specific parameters detailed in Figure 24_8 and Table 24_6.

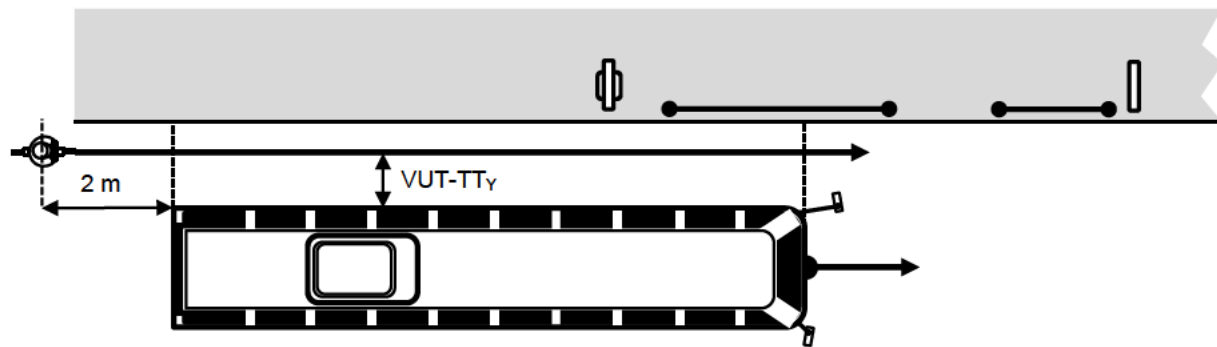

Figure 24_8: Test target positions at time T_0 for Cyclist Undertaking Bus Proximity Information signal (CUPI) scenario

Table 24_6: Definition of test scenario specific parameters for the Cyclist Undertaking Bus Proximity Information signal (CUPI) scenario

Parameter	Test Scenario		
	0.5m	1.0m	1.5m
$VUT-TT_y$	0.5m	1.0m	1.5m
$VUT-TT_x$ start (T_0)	$VUT_{rear} - 4m$	$VUT_{rear} - 4m$	$VUT_{rear} - 4m$
$VUT-TT_x$ end (T_1)	$VUT_{front} + 4m$	$VUT_{front} + 4m$	$VUT_{front} + 4m$
VRU Test Target	EBT	EBT	EBT

For all test scenarios, the VUT shall maintain a constant speed of 6.5mph \pm 0.5mph in the X-axis. The VUT speed shall be maintained as constant until the completion of the test (T_1).

The VRU test target speed shall be 10.0mph \pm 0.5mph, maintained as constant from the point 2 m rearward of the rearmost point of the VUT to a point 2 m forward of the front most point of the vehicle, excluding wingmirrors.

Start positions and initial accelerations for the VUT and the VRU test target shall be at the discretion of the Test Service, required to ensure the compliance with position requirements.



The start of each test shall be taken as T_0 (position X_0), where the VRU test target is 2m behind the rear of the VUT.

The completion of each test shall be taken as T_1 , where the VRU test target is 2m in front of the VUT.

The status of the blind spot information and warning signals shall be recorded, along with VRU test target position, from time T_0 to T_1 .

The evaluation distance shall be taken as between the point where the VRU is 1 m rearward of the rearmost point of the VUT to the point where the VRU is in line with the frontmost point of the VUT, excluding wingmirrors.

Each specified test scenario shall be undertaken once.

8.2.3 Bus Overtaking Cyclist Proximity Information signal (BOPI) Scenario

This test assesses the ability of a system to detect a cyclist manoeuvring at a low relative speed along the nearside of a bus and provide effective VRU proximity information signal.

The vehicle under test, test target and standardised environmental clutter shall be set up as specified in Section 8.2.1 with additional test scenario specific parameters as detailed in Figure 24_9 and



Table 24_7.

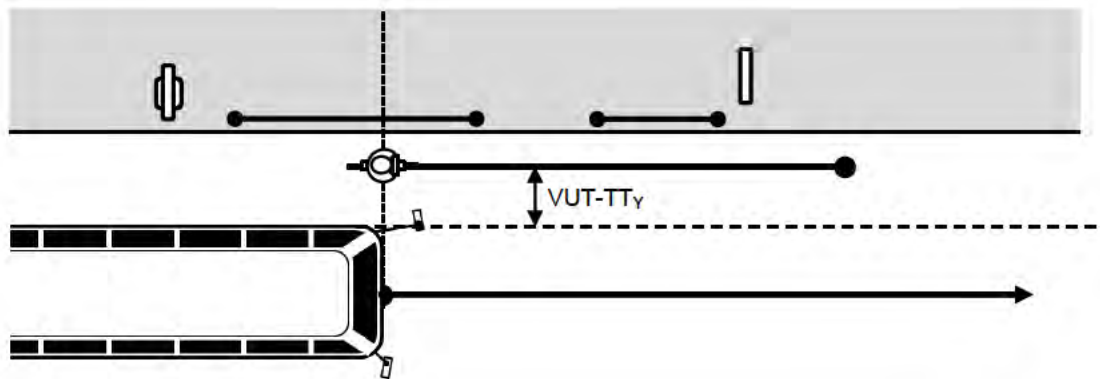

Figure 24_9: Vehicle under test and test target position at time T_0 for Bus Overtaking Cyclist Proximity Information signal (BOPI) scenario



Table 24_7: Definition of test scenario specific parameters for the Bus Overtaking Cyclist Proximity Information signal (BOPI) scenario

Parameter	Test Scenario		
TV-TT _Y	0.5m	1.0m	1.5m
TV-TT _X at T ₀	VUT _{rear} - 2m	VUT _{rear} - 2m	VUT _{rear} - 2m
TV-TT _X at T ₁	VUT _{front} + 0m	VUT _{front} + 0m	VUT _{front} + 0m
TV-TT _X at T ₂	VUT _{front} + 2m	VUT _{front} + 2m	VUT _{front} + 2m
VRU Test Target	EBT	EBT	EBT

For all test scenarios, the VUT shall maintain a constant speed of 10mph \pm 0.5mph in the X-axis. The VUT speed shall be maintained as constant until the completion of the test (T₁).

The VRU test target shall maintain a constant speed of 6.5mph \pm 0.5 mph in the X-axis, along a line parallel to the VUT, at the specified distance of separation in the Y-axis to the LH side of the bus.

The VUT and VRU shall travel at their constant test speeds from T₀ until the T₂.

Start positions and initial accelerations for the VUT and the VRU test target shall be at the discretion of the Test Service, required to ensure the compliance with position requirements.

The start of each test shall be taken as T₀, where the VUT is 2 m rearward of the VRU.

The completion of each test shall be taken as T₂, where the VRU is 2 m rearward of the rearmost point of the VUT.

The status of the blind spot information and warning signals shall be recorded, along with the VRU test target and VUT positions, from time T₀ to T₁.

The proximity signal evaluation distance shall be taken as the difference between the VRU test target positions at T₀ and the point where the VRU is in line with the front most point of the VUT, excluding wing mirrors, (T₁)

Each specified test scenario shall be undertaken once.

8.2.4 Cyclist Nearside turn Collision Warning (CTCW) Scenario

This test assesses the ability of a system to detect a cyclist manoeuvring along the nearside whilst the bus performs a nearside turn and provide effective VRU proximity information and collision warning signals.

The vehicle under test and test target shall be set up as specified in Section 8.2.1, without need for street furniture. Additional test scenario specific parameters as detailed in Figure 24_10 and Table 24_8. The test scenario has been designed to replicate the relative approach of the VUT and test target with the VUT traveling tangential to the arc of its turn at the point of collision. This has been chosen to ensure a comparable, reproducible and repeatable test.

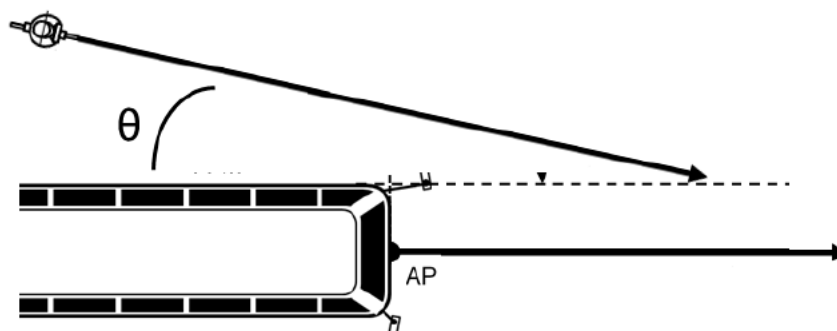

Figure 24_10: Vehicle under test and test target paths for Cyclist Nearside Turn Collision Warning (CTCW) scenario

For all test scenarios, the VUT shall maintain a constant speed of 10mph \pm 0.5 mph in the X-axis until the completion of the test (T_1).

The VRU test target shall maintain a constant speed of 12 mph \pm 0.5 mph at the specified angle, θ , from the X-axis of the VUT.

Start positions and initial accelerations for the VUT and the VRU test target shall be at the discretion of the Test Service, required to ensure the compliance with position requirements.

Start time, T_0 , shall be taken as time for each scenario when TTC is 5 seconds.

The completion of each test, T_1 shall be defined as the point at which $TTC = 0.75$ seconds. At T_1 , the VRU test target is to be decelerated to 0 mph to avoid unnecessary damage to the test target.

Tests shall be conducted so as to achieve a collision point at nearside outermost edge of the VUT at positions 25%, 50% and 75% of the vehicle length.

Table 24_8: Definition of test scenario specific parameters for the Cyclist Nearside Turn Collision Warning (CTCW) scenario

Parameter	Test Scenarios to be repeated at; 25%, 50%, 75% of the vehicle length		
V_{TT} at T_0	12mph	12mph	12mph
V_{VUT} at T_0	10mph	10mph	10mph
θ	10°	15°	20°
Collision point	25%, 50% and 75%	25%, 50% and 75%	25%, 50% and 75%
VRU Test Target	EBT	EBT	EBT

The status of the blind spot information and warning signals shall be recorded, along with the VRU test target and VUT positions, from time T_0 to end of test, T_1 .

The collision warning evaluation distance shall be taken as the difference between the VRU test target positions at T_0 and T_1 .

Each specified test scenario shall be undertaken once.

8.2.5 Nearside Turn Crossing Pedestrian Collision Warning (NPCW) Scenario

This test assesses the ability of a system to detect a pedestrian crossing an entrance to a road whilst the bus performs a nearside turn into the road and provide effective VRU proximity information and collision warning signals. The vehicle under test, test target and standardised environmental clutter shall be set up as specified in Section 8.2.1 with additional test scenario specific parameters as detailed in Figure 24_11. The test shall be conducted on a EuroNCAP specification junction.

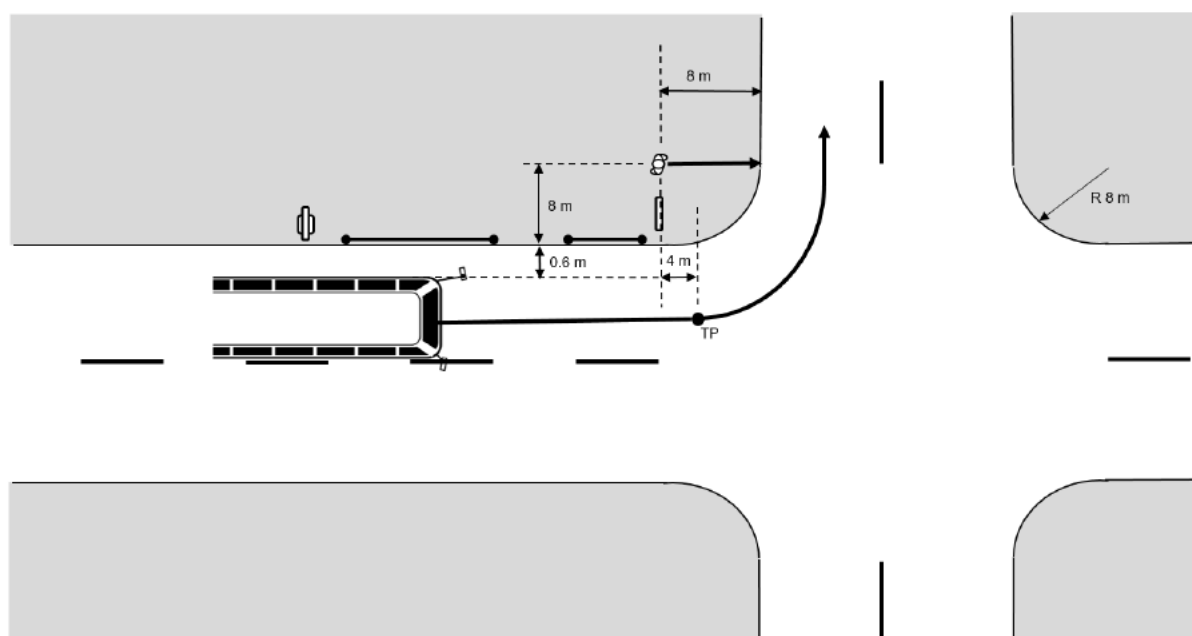

Figure 24_11: Vehicle under test and test target paths for Nearside Turn Crossing Pedestrian Collision Warning (NPCW) scenario

The VUT shall maintain a constant speed of $6.5\text{mph} \pm 0.5\text{mph}$ from a point 10 m prior to the turn point (TP), at (T_0), until the completion of the test (T_3).

At the TP, steering shall be applied to the VUT such that the foremost point of its centreline follows the arc of a circle with a radius (R) of 10 m.

The VRU test target shall be located a distance of +8.0 m in the Y-axis direction from the road edge, such that it enters the road at the first point at which the bus straightens after completing the turning manoeuvre. The VUT shall be located a distance of -0.5 m in the Y-axis from the road edge.



The VRU test target shall be accelerated in the direction of the positive X-axis to a nominal steady state speed of 2.5mph \pm 0.5mph within a distance of 2 m. The VRU test target shall commence acceleration at the moment in time such that when the constant speed is maintained for a distance of 4 m, the VRU would collide with a point 50% down the length of the bus were the VRU to maintain a constant speed.

When the VRU is a distance of 1.5m from the collision point it shall decelerate, achieving a complete stop at a distance 0.5m from the collision point. The moment in time that the VRU starts decelerating shall be defined as T_1 , and the point at which the VRU stops shall be defined as T_2 .

The speed of the VRU test target may be varied in response to the actual speed and path achieved by the VUT to ensure compliance with the above criteria.

The start of each test shall be taken as T_0 .

The completion of each test (T_3) shall be defined as $T_2 + 3$ seconds.

The status of the blind spot information and warning signals shall be recorded, along with the VRU test target and VUT positions, from time T_0 to T_3 .

Proximity signal evaluation distance shall be defined as the difference between the VRU test target positions $T_1 - 2$ seconds and T_1 .

Collision Warning evaluation distance shall be taken as the difference between positions at TP and T_1 .

This test scenario shall be undertaken once.

8.2.6 Nearside Turn No Test Target (NTNT) Scenario

This test assesses the false positive rate of a system in high levels of environmental clutter for both the VRU proximity information and collision warning signals. This may be used to evaluate the effectiveness of the system in differentiating between the at-risk VRUs and the environment.

The NTNT scenario shall be conducted in exactly the same manner as the NPCW scenario. Instead of a VRU test target, as used for the NPCW scenario, an obscuration dummy shall be used. The dummy shall be positioned in the same location as that defined in the NPCW scenario for the test target at T_0 . The VUT and standardised environmental clutter shall be set up as specified in Section 8.2.1, with additional test scenario specific parameters as detailed in 24_11.

This test scenario shall be undertaken once.

9 Assessment of results

9.1 Moving-Off Proximity Information signal (MOPI) Scenario

Test Scenario Performance Evaluation

The evaluation of the system performance during the Moving-Off Proximity Information Signal (MOPI) test scenarios shall be assessed according to Table 24_9.

Where percentage of evaluation distance is stated the results metric generated shall be a sliding scale between the maximum and minimum stated values.



Table 24_9: Evaluation of test performance for the Moving-Off Proximity Information signal (MOPI) test scenarios

Test Scenario	Points Available	Result Criteria	Result Metric	Score
All Scenarios (False Positive)	-2 to 0	Proximity information signal status before T_0 in any test condition	Inactive: [0] Active: [-2]	
Adult Close (True Positive)	0 to 1	Percentage of evaluation distance for which proximity information signal was active	100% Active: [1] . . . 0% Active: [0]	
Child Mid (True Positive)	0 to 1		100% Active: [1] . . . 0% Active: [0]	
Adult Far (False Positive)	-1 to 0		0% Active: [0] . . . 100% Active: [-1]	
All Scenarios (False Positive)	-2 to 0		Collision warning status in any test scenario	Inactive: [0] Active: [-2]
Max. Points	2	Total Score		
Total Score/Max. Points				

9.1.1 HMI Performance Evaluation

The evaluation of the performance of the blind spot system HMI across all Moving-Off Proximity Information signal (MOPI) test scenarios shall be assessed according to Table 24_10.



Table 24_10: Evaluation of human-machine interface (HMI) performance for the Moving-Off Proximity Information signal (MOPI) test scenarios

HMI Criteria	Points Available	Result Criteria	Score
Proximity information signal transmitted using a visual mode	0 to 3	Visual: [3] Tonal or Haptic or Speech: [0]	
Visual proximity information signal located within a horizontal field of view angle between $\pm 30^\circ$ from XZ plain, without causing an obstruction to direct or indirect vision	-1 to 1	In zone: [1] Out of zone: [0] Causing obstruction to vision: [-1]	
Visual proximity information signal is amber in colour	0 to 1	Amber: [1] Other colour: [0]	
Visual proximity information signal ceases automatically within [1] second of the VRU moving out of vehicle path	0 to 1	Ceases < [1.0] sec: [1] Ceases > [1.0] sec: [0]	
Max. Points	6	Total Score	
Total Score/Max. Points			

9.2 Moving-Off collision Warning and motion Inhibit (MOWI) Scenario

9.2.1 Test Scenario Performance Evaluation

The evaluation of the blind spot system performance during the Moving-Off collision Warning and motion Inhibit (MOWI) test scenarios shall be assessed in accordance with Table 24_11.

Where percentage of evaluation distance is stated the results metric generated shall be a sliding scale between the maximum and minimum stated values.



Table 24_11: Evaluation of test performance for the Moving-Off collision Warning and motion Inhibit (MOWI) test scenarios

Test Scenario	Points Available	Result Criteria	Result Metric	Score
Adult Close (Motion Inhibit)	0 to 1	The vehicle remains stationary despite the driver actions	Stationary: [1] Motion: [0]	
Child Close (Motion Inhibit)	0 to 1		Stationary: [1] Motion: [0]	
Adult Far (Motion Inhibit or Collision Warning)	0 to 1	The vehicle remains stationary despite the driver actions	Stationary: [1] Motion: [0]	
	0 to 1	Percentage of evaluation distance for which collision warning was active	100% Active: [1] . . . 0% Active: [0]	
Max. Points	3	Total Score		
Total Score/Max. Points				

9.2.2 HMI Performance Evaluation

The evaluation of the performance of the blind spot system HMI across all Moving-Off collision Warning and motion Inhibit (MOWI) test scenarios shall be assessed in accordance with Table 24_12.



Table 24_12: Evaluation of human-machine interface (HMI) performance for the Moving-Off collision Warning and motion Inhibit (MOWI) test scenarios

HMI Criteria	Points Available	Result criteria	Score
Collision warning signal is transmitted using visual and one other mode	0 to 1	Multi-mode inc. visual: [1] Single mode: [0]	
Collision warning signal is transmitted over at least one of audible/haptic modes	0 to 1	Audible/Haptic Mode: [1] No Audible/Haptic Mode: [0]	
Collision warning signal uses a different mode to the proximity information signal or is distinctly different in presentation	0 to 1	Different: [1] Similar: [0]	
Visual collision warning signal located within a horizontal field of view angle between $\pm 30^\circ$ from XZ plain, without causing an obstruction to direct or indirect vision	0 to 1	In zone: [1] Out of zone: [0] Causing obstruction to vision: [-1]	
Visual collision warning signal is red in colour	0 to 1	Red: [1] Other colour: [0]	
Visual collision warning signal displayed on windscreen via a head-up display that does not obstruct driver vision	0 to 1	HUD: [1] No HUD: [0]	
Audible collision warning signal does not use speech	0 to 1	Tonal: [1] Speech: [0]	
Tonal collision warnings are distinct from other sounds used within the vehicle	0 to 1	Distinct: [1] Similar: [0]	
Tonal collision warnings have a signal to ambient noise ratio of greater than 1.3 between relevant loudness spectra	0 to 1	s/n ratio >1.3: [1] s/n ratio \leq 1.3: [0]	
Collision warning signal automatically ceases in less than [1] second after T_1	0 to 1	Ceases < [1.0] sec: [1] Ceases > [1.0] sec: [0]	
Max. Points	10	Total Score	
Total Score/Max. Points			



9.3 Cyclist Undertaking Bus Proximity Information signal (CUPI) Scenario

9.3.1 Test Scenario Performance Evaluation

The evaluation of the performance of the blind spot system during the Cyclist Undertaking Bus Proximity Information signal (CUPI) test scenarios shall be assessed in accordance with Table 24_13.

Where percentage of evaluation distance is stated the results metric generated shall be a sliding scale between the maximum and minimum stated values.

Table 24_13: Evaluation of test performance for the Cyclist Undertaking Proximity Information signal (CUPI) test scenarios

Test Scenario	Points Available	Result Criteria	Result Metric	Score
All Scenarios (False Positive)	-2 to 0	Proximity information signal status before T_0 in any test scenario	Inactive: [0] Active: [-2]	
Cyclist 0.5m (True Positive)	0 to 1	Percentage of evaluation distance for which proximity information signal was active	100% Active: [1] . . . 0% Active: [0]	
Cyclist 1.0m (True Positive)	0 to 1	Percentage of evaluation distance for which proximity information signal was active	Active: [1] . . . Inactive: [0]	
Cyclist 1.5m (True Positive)	0 to 1	Percentage of evaluation distance for which proximity information signal was active	100%Active: [1] . . . 0% Active: [0]	
All Scenarios (False Positive)	-2 to 0	Collision warning status in any test scenario	Inactive: [0] Active: [-2]	
Max. Points	3	Total Score		
Total Score/Max. Points				

9.3.2 HMI Performance Evaluation

The evaluation of the performance of the blind spot system HMI across all Cyclist Undertaking Proximity Information signal (CUPI) test scenarios shall be assessed according to Table 24_14.



Table 24_14: Evaluation of human-machine interface (HMI) performance for the Cyclist Undertaking Bus Proximity Information signal (CUPI) test scenarios

HMI Criteria	Points Available	Result Criteria	Score
Proximity information signal transmitted over the visual mode only	0 to 3	Visual: [3] Tonal/Haptic/Speech: [0]	
Visual proximity information signal located within a horizontal field of view angle between $\pm 30^\circ$ towards the nearside of the vehicle, without causing an obstruction to direct or indirect vision	0 to 1	In zone: [1] Out of zone: [0] Causing obstruction to vision [-1]	
Visual proximity information signal is amber in colour	0 to 1	Amber: [1] Other colour: [0]	
Max. Points	5	Total Score	
Total Score/Max. Points			

9.4 Bus overtaking Cyclist Proximity Indicator (BOPI) Scenario

9.4.1 Test Scenario Performance Evaluation

The evaluation of the performance of the blind spot system during the Bus overtaking cyclist proximity indicator (BOPI) test scenarios shall be assessed in accordance with Table 24_15.

Where percentage of evaluation distance is stated the results metric generated shall be a sliding scale between the maximum and minimum stated values.



Table 24_15: Evaluation of test performance for the Bus overtaking cyclist Proximity Indicating (BOPI) test scenarios

Test Scenario	Points Available	Result Criteria	Result Metric	Score
All Scenarios (False Positive)	-2 to 0	Proximity information signal status before T_0 in any test scenario	Inactive: [0] Active: [-2]	
Cyclist 0.5m (True Positive)	0 to 1	Percentage of evaluation distance for which proximity information signal was active	Active: [1] . . . Inactive: [0]	
Cyclist 1.0m (True Positive)	0 to 1	Percentage of evaluation distance for which proximity information signal was active	Active: [1] . . . Inactive: [0]	
Cyclist 1.5m (True Positive)	0 to 1	Percentage of evaluation distance for which proximity information signal was active	Active: [1] . . . Inactive: [0]	
All Scenarios (False Positive)	-2 to 0	Collision warning status in any test scenario	Inactive: [0] Active: [-2]	
Max. Points	3	Total Score		
Total Score/Max. Points				

9.4.2 HMI Performance Evaluation

The evaluation of the performance of the blind spot system HMI across all Bus overtaking cyclist Proximity indicator (BOPI) test scenarios shall be assessed according to Table 24_16.



Table 24_16: Evaluation of human-machine interface (HMI) performance for the Bus overtaking cyclist Proximity Indicator (BOPI) test scenarios

HMI Criteria	Points Available	Result Criteria	Score
Proximity information signal transmitted over the visual mode only	0 to 3	Visual: [3] Tonal/Haptic/Speech: [0]	
Visual proximity information signal located within a horizontal field of view angle between $\pm 30^\circ$ towards the nearside of the vehicle, without causing an obstruction to direct or indirect vision	0 to 1	In zone: [1] Out of zone: [0] Causing obstruction to vision [-1]	
Visual proximity information signal is amber in colour	0 to 1	Amber: [1] Other colour: [0]	
Max. Points	5	Total Score	
Total Score/Max. Points			

9.5 Cyclist Nearside Turn Collision Warning (CTCW) Scenario

9.5.1 Test Scenario Performance Evaluation

The evaluation of the performance of the blind spot system during the Cyclist Nearside Turn Collision Warning (CTCW) test scenarios shall be assessed in accordance with Table 24_17.

Where percentage of evaluation distance is stated the results metric generated shall be a sliding scale between the maximum and minimum stated values.

Table 24_17: Evaluation of test performance for the Cyclist Nearside Turn Collision Warning (CTCW) test scenarios

Test Scenario	Points Available	Result Criteria	Result Metric	Score
Collision 25% of vehicle length (Collision Warning)	0 to 2	Percentage of collision test evaluation distance for which collision warning was active	100% Active [2] . . 0% Active [0]	
Collision 25% of vehicle length (Premature Collision Warning)	-1 to 0	Collision warning status before T_0 in any test scenario	Inactive: [0] Active: [-1]	
Collision 50% of vehicle length (Collision Warning)	0 to 2	Percentage of collision test evaluation distance for which collision warning was active	100% Active [2] . . 0% Active [0]	
Collision 50% of vehicle length (Premature Collision Warning)	-1 to 0	Collision warning status before T_0 in any test scenario	Inactive: [0] Active: [-1]	
Collision 75% of vehicle length (Collision Warning)	0 to 2	Percentage of collision test evaluation distance for which collision warning was active	100% Active [2] . . 0% Active [0]	
Collision 75% of vehicle length (Premature Collision Warning)	-1 to 0	Collision warning status before T_0 in any test scenario	Inactive: [0] Active: [-1]	
Max. Points	6	Total Score		
		Total Score/Max. Points		

HMI Performance Evaluation

The evaluation of the performance of the blind spot system HMI across all Cyclist Nearside Turn Collision Warning (CTCW) test scenarios shall be assessed according to Table 24_18.



Table 24_18: Evaluation of human-machine interface (HMI) performance for the Cyclist Nearside Turn Collision Warning (CTCW) test scenarios

HMI Criteria	Points Available	Result Criteria	Score
Collision warning signal is transmitted using visual and one other mode	0 to 1	Multi-mode inc. visual: [1] Single mode: [0]	
Collision warning signal is transmitted over at least one of audible/haptic modes	0 to 1	Audible/Haptic Mode: [1] No Audible/Haptic Mode: [0]	
Collision warning signal uses a different mode to the proximity information signal or is distinctly different in presentation	0 to 1	Different: [1] Similar: [0]	
Collision Warning information signal located within a horizontal field of view angle between $\pm 30^\circ$ towards the nearside of the vehicle, without causing an obstruction to direct or indirect vision	0 to 1	In zone: [1] Out of zone: [0]	
Visual collision warning signal is red in colour	0 to 1	Red: [1] Other colour: [0]	
Audible collision warning signal does not use speech coding	0 to 1	Tonal: [1] Speech Coding: [0]	
Tonal collision warnings are distinct from other sounds used within the vehicle	0 to 1	Distinct: [1] Similar: [0]	
Tonal collision warnings have a signal to ambient noise ratio of greater than 1.3 between relevant loudness spectra	0 to 1	s/n > 1.3: [1] s/n \leq 1.3: [0]	
Collision warning signal automatically ceases in less than [2] seconds after T_1	0 to 1	Ceases < [2] sec: [1] Ceases \geq [2] sec: [0]	
Max. Points	9	Total Score	
Total Score/Max. Points			



9.6 Nearside Turn Pedestrian collision warning (NPCW) Scenario

9.6.1 Test Scenario Performance Evaluation

The evaluation of the performance of the blind spot system during the Nearside Turn Pedestrian collision warning (NPCW) test scenario shall be assessed according to Table 24_19.

Where percentage of evaluation distance is stated the results metric generated shall be a sliding scale between the maximum and minimum stated values.

Table 24_19: Evaluation of test performance for the Nearside Turn Pedestrian collision warning (NPCW) test scenario

Test Scenario	Points Available	Result Criteria	Result Metric	Score
Pedestrian (Proximity Information Signal)	0 to 1	Percentage of total proximity test evaluation distance for which proximity information signal was active	100% Active: [1] . . . 0% Active: [0]	
Pedestrian (Collision Warning)	0 to 2	Percentage of collision test evaluation distance for which collision warning was active	100% Active: [2] . . . 0% Active: [0]	
Pedestrian (Premature Collision Warning)	-2 to 0	Collision warning status before TP in any test scenario	Inactive: [0] Active: [-2]	
Max. Points	3	Total Score		
Total Score/Max. Points				

9.6.2 HMI Performance Evaluation

The evaluation of the performance of the blind spot system HMI across all Nearside Turn Pedestrian Collision Warning (NPCW) test scenarios shall be assessed according to



Table 24_20.



Table 24_20: Evaluation of human-machine interface (HMI) performance for the Nearside Turn Pedestrian Collision Warning (NPCW) test scenario

HMI Criteria	Points Available	Result Criteria	Score
Proximity information signal transmitted over the visual mode only	0 to 3	Visual: [3] Tonal/Haptic/Speech: [0]	
Visual proximity information signal located within a horizontal field of view angle between $\pm 30^\circ$ towards the nearside of the vehicle, without causing an obstruction to direct or indirect vision	0 to 1	In zone: [1] Out of zone: [0]	
Visual proximity information signal is amber in colour	0 to 1	Amber: [1] Other colour: [0]	
Visual proximity information signal ceases automatically on activation of the collision warning signal	0 to 1	Ceases on Activation: [1] Does not cease on Activation: [0]	
Collision warning signal is transmitted using visual and one other mode	0 to 1	Multi-mode inc. visual: [1] Single mode: [0]	
Collision warning signal is transmitted over at least one of audible/haptic modes	0 to 1	Audible/Haptic Mode: [1] No Audible/Haptic Mode: [0]	
Collision warning signal uses a different mode to the proximity information signal or is distinctly different in presentation	0 to 1	Different: [1] Similar: [0]	
Collision Warning information signal located within a horizontal field of view angle between $\pm 30^\circ$ towards the nearside of the vehicle, without causing an obstruction to direct or indirect vision	0 to 1	In zone: [1] Out of zone: [0]	
Visual collision warning signal is red in colour	0 to 1	Red: [1] Other colour: [0]	



Audible collision warning signal does not use speech coding	0 to 1	Tonal: [1] Speech Coding: [0]	
Tonal collision warnings are distinct from other sounds used within the vehicle	0 to 1	Distinct: [1] Similar: [0]	
Tonal collision warnings have a signal to ambient noise ratio of greater than 1.3 between relevant loudness spectra	0 to 1	s/n >1.3: [1] s/n ≤1.3: [0]	
Collision warning signal automatically ceases in less than [2] seconds after T₁	0 to 1	Ceases < [2] sec: [1] Ceases ≥ [2] sec: [0]	
Max. Points	15	Total Score	
			Total Score/Max. Points

9.7 Nearside Turn No test Target (NTNT) Scenario

9.7.1 Test Scenario Performance Evaluation

The evaluation of the performance of the blind spot system during the Nearside Turn No test Target (NTNT) test scenario shall be assessed in accordance with Table 24_21. No assessment of the HMI performance shall be performed for the Nearside Turn No test Target (NTNT) test scenario.

Table 24_21: Evaluation of test performance for the Nearside Turn No test Target (NTNT) test scenario

Test Scenario	Points Available	Result Criteria	Result Metric	Score
Proximity Information Signal (False Positive)	-1 to 0	Proximity information signal status in any test scenario	Inactive: [0] Active: [-1]	
Collision Warning (False Positive)	-2 to 0	Collision warning status in any test scenario	Inactive: [0] Active: [-2]	
Max. Points	0 (min -3)	Total Score		
				Total Score/Max. Points



9.8 General HMI Evaluation

Formal independent tests need not be undertaken in respect of the additional HMI requirements specified in Table 24_22. Assessment may be based on documentary evidence provided by the system supplier and demonstration of functionality.

Table 24_22: Requirements for warning systems

HMI Criteria	Points Available	Result criteria	Score
The device automatically switches off above a speed of 18.5mph	0 to 1	Switches Off: [1] Does Not Switch Off: [0]	
The operational status of the device is communicated to the driver	0 to 1	Status Communicated: [1] Status Not Communicated: [0]	
Visual displays use colour combinations recommended by ISO 15008:2009	0 to 1	Recommended: [1] Not recommended: [0]	
Visual displays shall have a brightness of $\geq 6000 \text{ cd/m}^2$ in daylight conditions	0 to 1	Brightness $\geq 6000 \text{ cd/m}^2$: [1] Brightness $< 6000 \text{ cd/m}^2$: [0]	
Visual displays have a (manually or automatically) adjustable brightness to compensate for ambient conditions	0 to 1	Adjustable: [1] Fixed: [0]	
Visual displays are of sufficient size with minimum dimensions of 12 mm x 12 mm on driver side and 20 mm x 20 mm on passenger side of vehicle	0 to 1	Sufficient Size: [1] Insufficient Size: [0]	
Max. Points	6	Total Score	
Total Score/Max. Points			

Motion inhibit systems shall be over-rideable by the driver to continue making progress in the event of a false positive.



9.9 Quality, Durability and Installation Requirements

Additional score will be awarded if the system or vehicle supplier can demonstrate documentary evidence of compliance with the requirements in Table 24_23.

Table 24_23: Requirements for Quality, Durability and Installation

Criteria	Points Available	Result criteria	Score
Complies with EN50498 for Electro-Magnetic Compatibility	0 to 1	Compliant: [1] Not Compliant: [0]	
Complies with UNECE Regulation 10.04 for immunity to radio frequency interference (RFI)	0 to 1	Compliant: [1] Not Compliant: [0]	
Complies with ISO 11452-9 or ISO 11451-3	0 to 1	Compliant: [1] Not Compliant: [0]	
Complies with the Mechanical Test aspects of ISO 16001	0 to 1	Compliant: [1] Not Compliant: [0]	
Complies with the Mechanical Test aspects of ISO 15998	0 to 1	Compliant: [1] Not Compliant: [0]	
Max. Points	5	Total Score	
Total Score/Max. Points			

9.10 Overall Rating

Each of the individual assessments defined across the previous sections will provide a normalised performance score between 0 and 1. Due to the characteristics of the London collision landscape, however, some test scenarios are deemed to be more important than others for preventing bus-to-VRU collisions. These individual scores are, therefore, weighted by importance then summed together to produce an overall Blind Spot information signal, Warning and intervention (BSW) performance score between 0% and 100%, as shown in Table 24_24.



Table 24_24: Weightings for overall Blind Spot information signal, Warning and intervention (BSW) performance rating score

Scenario	Evaluation Method	Evaluation Score (E)	Scenario Weighting	Collision Population Weighting	Scenario Weighting	Evaluation Method Weighting	Overall Weighting (W)	Weighted Score (W*E)
Moving-Off Proximity Information signal (MOPI)	Performance		90%	57%	45%	75%	0.173	
	HMI					25%		
Moving-Off collision Warning and motion Inhibit (MOWI)	Performance		90%	57%	55%	95%	0.268	
	HMI					5%		
Cyclist undertaking Bus Proximity Information signal (CUPI)	Performance		90%	15%	20%	75%	0.030	
	HMI					25%		
Bus Overtaking Cyclist Proximity Information signal (BOPI)	Performance		90%	15%	30%	75%	0.020	
	HMI					25%		
Cyclist Nearside Turn Collision Warning (CTCW)	Performance		90%	15%	30%	75%	0.030	
	HMI					25%		
Nearside Turn Crossing Pedestrian Collision Warning (NPCW)	Performance		90%	28%	100%	75%	0.189	
	HMI					25%		
Nearside Turn No test Target (NTNT)	Performance		90%	15%	20%	75%	0.020	
	HMI					25%		
Additional HMI Requirements			5%				0.050	
Quality, Durability & Installation			5%				0.050	
Overall BSW Performance Rating Score (%)								



10 Test Report

The Test Service shall provide a comprehensive Test Report that will be made available to TfL. The test report shall consist of three distinct sections:

- a) Performance data
- b) Confirmation of protocol compliance
- c) Reference information

The minimum performance data required is the completion of each table of results listed in this document.

In order to confirm protocol compliance, the Test Service shall:

- a) Include in the report processed data (e.g. graphs, tables etc.) that show that each test was compliant with its associated variables and tolerances
- b) Provide data on environmental validity criteria, including temperature, weather and lighting measurements, demonstrating compliance with respective limit values.

The reference information required includes as a minimum:

- a) Vehicle Make
- b) Vehicle Model
- c) Vehicle Model Variant
- d) BSW Hardware version (e.g. sensor types, ECU references)
- e) BSW Software version



Attachment 25: Blind Spot Warning

Guidance Notes

1 Introduction

The aim of the Blind Spot information signal, Warning and intervention (BSW) safety measure is to recognise that good vision alone will not guarantee that drivers will successfully avoid all collisions with VRUs in close proximity to buses performing low speed manoeuvres. Information signals, warnings and interventions based on the detection of vulnerable road users through electronic sensing systems can, therefore, still have a significant potential benefit in these circumstances. Separate requirements are intended to ensure that drivers have a good field of view from a bus in respect to vulnerable road users (VRUs) in close proximity to the bus.

This document sets out the guidance notes related to the testing and assessment of the safety performance of BSW systems. These guidance notes are aimed at bus operators and manufacturers as a practical guide for implementation of the Bus Safety Standard.

These notes are for guidance only, and are not legally binding. In all circumstances, guidance provided by the manufacturer of a bus or system shall take precedence, and these guidance notes are only for use in the absence of other information. These are not intended to be exhaustive, but to point the operators toward practical advice and questions to raise with manufacturers/suppliers.

2 Selection of buses/systems

Any bus that meets the TfL Bus Vehicle Specification.

The blind spot information warning and intervention (BSW) requirements may be assessed against a new build bus with functions integrated in the factory by the bus OEM, or against a vehicle fitted with a system supplied by an organisation other than a bus OEM either for dealer fit or as an aftermarket fitment.

2.1 Compliance and warranty

A bus operator should seek evidence from the system supplier and/or bus manufacturer that a dealer fit or aftermarket fitted device does not create any warranty problems for the bus OEM. Operators should also be aware that a regulation governing the technical standards of systems with some of the functionality described in the assessment is in development and will be applied to HGVs. It is possible that this may be extended to buses, but any regulatory requirements will only apply to new buses first registered from the relevant future date. It will not render devices fitted before that time illegal, even if they do not comply with the new requirements.



2.2 Interpreting the requirements and selecting the most effective way to fulfil them

In order to recognise a potentially dangerous situation during low speed manoeuvres and successfully avoid a collision, then the following elements are required:

- **Available to be seen:** The hazard (pedestrian, cyclist, other vehicle etc.) needs to be available to be seen by the driver sufficiently ahead of time to allow avoiding action to be taken. That is, the hazard needs to be in view at least around 2 seconds before collision.
- **Alert and attentive:** The driver needs to be attentive to the road and traffic environment and alert to the possible need to react.
- **Looking in the right direction:** In complex driving situations, the driving task can demand attention in multiple different directions; the driver needs to be looking in the right direction at the right time to see the hazard. In dynamic moving environments this is not guaranteed even if the driver is alert and attentive.
- **Recognition:** Once the hazard is seen, then the driver must recognise the hazard and the risk that it poses.
- **Reaction:** Once the risk is recognised, the driver must react quickly and correctly to the risk. In some circumstances this may be steering around the hazard, in many it will be braking the vehicle to a stop and in others it might simply be to remain stationary instead of moving off from rest.

Thus, the ability to avoid a collision in the low speed manoeuvring circumstances envisaged for BSW systems is also strongly related to the vision performance of the bus and so the two safety measures should be considered together so that they are complementary and work in synergy.

BSW systems can supplement the vision requirements in circumstances where the hazard is still unavailable to be seen by the driver. However, the main benefit is likely to be in drawing the drivers attention to the presence of the hazard when, either for legitimate reasons of driver workload or for reasons of distraction or fatigue, the driver is not looking in the direction of the hazard at the exact time needed to avoid collision. In these circumstances the BSW can draw the driver attention to the right spot at the right time where the hazard will be visible in direct or indirect vision such that it maximises the chance of prompt recognition and correct reactions.

In order to achieve this, the way that the systems interact with the driver to inform them, warn them or intervene on their behalf is considered critical to the likely success of the system. This aspect of system design is known as the human-machine interface, or HMI. Measures are in place to encourage good HMI in the test and assessment protocol and are based on established industry standards (e.g. ISO standards). They are typically related to the criticality of the driving situation (is a collision likely in the next couple of seconds, in a longer period or not necessarily likely at all) and the urgency of the warning. However, HMI has inevitable subjective elements and can be difficult to measure objectively so there will still be room for substantial variation in the systems available on the market. The guidance below provides both the rationale for the protocol requirements and information to help operators choose systems that they believe will work well with their vehicles, in the operating environments the vehicles will be used in and by their drivers.



2.3 Proximity information signals

Proximity information signals are systems that will inform the driver any time a vulnerable road user is in close proximity to the vehicle. In London traffic these will be issued very frequently. In the vast majority of these situations, the situation will not be critical i.e. a collision will not be imminent in the next couple of seconds and the driver may well already be well aware of the presence of the hazard. Thus, reaction to non-critical situations should be discouraged and the warning should not be urgent or intrusive. In these circumstances an urgent, intrusive warning such as a loud tonal sound, a buzzer etc. can be annoying to the driver. They may subconsciously tune the warning out such that they ignore it when it is really needed or they may even find ways of disabling the system. Thus, examples of amber visual warnings may be much more acceptable to the driver in the many cases where the situation is not critical and/or they were already aware, while still providing useful information about the presence of hazards, when they are hidden or the driver has not seen them.

2.4 Collision warnings

Collision warnings should be issued only when the driving situation is critical i.e. the system has calculated that a collision is imminent in the next few seconds. Thus, even in London traffic they should go off far less frequently than proximity warnings. In this case, it is necessary for the warnings to be urgent and intrusive because they must quickly grab the attention of the driver and provoke rapid action to prevent a collision. These intrusive warnings are far less likely to annoy the driver, firstly because they should be far less frequent than proximity warnings and secondly because if they are working well it should be possible for the driver to see the reason for the warning in the majority of instances. False or premature activations when either the system has misdiagnosed the situation or reacted too soon will undermine driver confidence in the system and should be minimised, though what constitutes 'too soon' or even 'false' is to some degree subjective and driver dependent.

As such warnings issued over more than one channel (e.g. audible and visual and/or haptic warnings that are felt such as vibrations) are desirable, and speech warnings are undesirable because they take a finite time to complete and the drivers take a finite amount of time to process and understand the warning. Visual warnings should be red and audible warnings sufficiently loud to be heard against the backdrop of engine/passenger noise etc.

2.5 Other alert/warning signals

It should be noted that the test and assessment protocol only considers information signals and collision warnings in relation to close proximity manoeuvring but system suppliers may offer such signals in other driving circumstances, for example in relation to lane departure or imminent collision with a vehicle ahead. The requirements of the Bus Vehicle Specification and the test and assessment protocol do not apply to these other functions but also do not prohibit them. You can have other functions on the vehicle if considered beneficial. However, operators should consider the same HMI principles in relation to these other warnings and consider driver workload, recognition and reaction issues in terms of how well the system communicates the type of hazard to the driver such that it maximises the chance of a



quick and correct response and avoids driver confusion. Having very similar anonymous beeps in reaction to multiple different undesirable traffic situations is unlikely to maximise driver effectiveness in collision avoidance.

2.6 Signal directionality and workload

Systems that draw the driver's attention in the direction of the hazard are considered more desirable than those that do not. For example, a system detecting the proximity of a cyclist to the left of the bus might illuminate an amber visual warning at the left side of the bus. By contrast a system that issues an audible and visual collision warning at a point low down in the dashboard near the driver, actually draws driver attention away from the hazard and may well be less effective as a consequence and generally increase driver workload.

2.7 Intervention systems

Even with the best vision and a high quality warning, successful collision avoidance will still rely on the driver taking the correct course of action sufficiently quickly and is, therefore, not guaranteed. Intervention systems will act in the event that the driver does not make the correct avoidance action or makes it insufficiently quickly. There are also clear risks with intervention systems if, for example, they misdiagnose the situation and intervene when they should not.

2.7.1 Vehicle Moving

At the time of drafting the BSW requirements, there were no systems available which automated emergency braking systems during low speed manoeuvres (i.e. <10 km/h), particularly during left or right turns. Although it is known that prototypes are in development, technical challenges remain around sensor accuracy, sensor fields of view and brake build up times, so it is not clear when they would be available. Systems which would prevent a collision by use of brakes or other means, whilst the vehicle is moving at low speed, have therefore not been included in the bus safety standard. Systems are not prohibited and if they become available should be analysed, assessed and considered.

2.7.2 Vehicle moves off from rest

Collisions where the vehicle moves off from rest and hits a pedestrian immediately in front of the vehicle present a particular challenge. In HGVs they are thought to occur because of blind spots. Buses typically do not suffer from such blind spots but collisions do still occur, albeit relatively less frequently. One possible explanation for this is that the driver is legitimately looking over their shoulder to check it is clear to move out from a bus stop into traffic at the time they move off. A non-intrusive visual warning may or may not be sufficient to draw the attention of the driver to the hazard given how far away from the relevant direction they may be looking.

By definition, a collision warning can only activate once the vehicle first moves such that it is on a collision course. If the pedestrian is close to the front of the vehicle, a collision warning may be issued too late for the driver to react and stop before the collision occurs, though it may still prevent run-over by the wheels.



A system may prevent moving off from rest when a VRU is detected in front of the vehicle. This may be achieved by, for example, disabling the response to application of the accelerator pedal. This would result in the vehicle remaining stationary which is seen as a low risk.

In the event of a spurious activation, preventing the vehicle from moving off whilst in a safe condition, a driver over-ride shall be provided to prevent the vehicle being 'marooned'. This over-ride should not be so easy to activate that it could be done accidentally but not so complicated that the driver would forget how to do it. Driver over-ride should only be activated when the driver is absolutely confident there is no hazard immediately in front of the vehicle. Once the system determines that the detected hazard has been avoided the over-ride function should deactivate to enable system to prevent moving off from rest in future. .

3 Training

3.1 For test houses

Test houses accredited to undertake Euro NCAP AEB tests will have the skills and equipment required for these tests. Test houses without such accreditation will be required to demonstrate to TfL at their expense that they can achieve the same standard of testing as an accredited organisation.

3.2 Bus drivers

Drivers should be familiarised with the system such that they know what any warnings mean and, where applicable, how to over-ride an intervention system and when to do so. They should also be trained to understand the circumstances where the system can help them and those where it can't, for example, if a system does not perform at night or in adverse weather.

3.3 Shift Supervisors

Supervisors should also be familiar with systems such that they can answer any questions from drivers and recognise any problems that may require maintenance.

3.4 Bus maintenance engineers

The engineers carrying out general bus maintenance should be aware of the location and details of the sensors and warning displays/tell tales. They should be trained in any routine maintenance required (e.g. keeping sensors clean, free from obstruction etc.) and how to fault find and repair the system.

4 Maintenance

Operators are encouraged to establish what (if any) daily checks are required, and to plan for these additional operational costs.

5 Repair



If the driver or anyone else reports a failure or a problem with the system this should be investigated and, if confirmed, repaired.



Attachment 26: Pedal Application Error

Assessment Protocol

1 Introduction

This document presents a procedure for objectively assessing the performance of systems designed to stop incidents of pedal application error from occurring and to aid recovery from pedal application error.

For full understanding of this Attachment it should be read in conjunction with the New Bus Specification, Section 4.3.5.2 and Attachment 27 – Pedal Application Error Guidance Notes

2 Scope

This protocol applies to all new buses intended for service under contract to TfL that are passenger vehicles with a maximum mass exceeding 5 tonnes and a capacity exceeding 22 passengers. The passenger vehicles will be capable of carrying seated but unrestrained occupants and standing occupants. Such vehicles are categorised the Consolidated Resolution on the Construction of Vehicles (R.E.3) as M₃; Class I, Class II.

The pedal acoustic feedback assessment shall only apply to quiet running buses with a hybrid (HEV), pure electric (PEV), electrified vehicle (EV), fuel cell vehicle (FCV) or a fuel cell hybrid vehicle (FCHV) drivetrain.

3 Purpose

The purpose of this assessment is to provide data from a controlled and repeatable test that can be used to assess the potential benefits (reduced casualties and damage) of a system to minimise pedal application error incidents, namely:

- The misapplication of the accelerator pedal; or
- The failure of the drivers to realise that they have applied the incorrect pedal.

In addition to measuring aspects of vehicle dynamics, the protocol provides a method for measuring how the system affects driver performance and how drivers interact with and understand the system.

4 Normative references

The following normative documents, in whole or in part, are referenced in this document and are indispensable for its application. For dated references, only the edition cited applies. For undated references, the latest edition of the referenced document (including any amendments) applies.

- London Bus Services Limited New Bus Specification: Section 4.3.5.2



- London Bus Services Limited New Bus Specification: Attachment 27 – Pedal Application Error Guidance Notes
- UNECE Regulation No, 121 - Uniform Provisions Concerning the Approval of: Vehicles with Regard to the Location and Identification of Hand Controls, Tell-tales and Indicators
- ISO 2575:2004 – Road Vehicles – Symbols for controls, indicators and tell-tales.
- NHTSA Human Factors Design Guidance for Driver-Vehicle Interfaces (DOT HS 812 360).

5 Definitions

For the purpose of this Protocol:

- **ALS: Accelerator Light System** – a light system to inform the driver which pedal is currently being pressed.
- **Approval Authority** – the body within TfL that certifies that a bus is approved for use in the TfL fleet and assigns its score under the Bus Safety Standard for use in procurement processes.
- **BTS: Brake Toggle System** – a system that requires an extra brake press in order to release the halt brake after the bus doors have opened or the passenger ramp has been lowered.
- **CAN bus: Controller Area Network bus** – a vehicle bus standard to allow communication between microcontrollers and devices in applications without a host computer.
- **Halt Brake** – an automated braking system that prevents a bus from moving under certain conditions (e.g. when the bus doors are open or the bus ramp is lowered).
- **New Build** – a vehicle that has been built by the Vehicle ManufacturerOEM with the system to be assessed fitted during the assembly process prior to first registration of the vehicle.
- **OEM: Original Equipment Manufacturer** - The company responsible for the manufacture of a completed bus, delivered to a bus operator
- **Pedal Acoustic Feedback System** – a system fitted on quiet running buses that provides an acoustic feedback to the driver as to the acceleration and change of acceleration of the bus as determined by pedal usage, in order to help the driver recover from pedal confusion incident.
- **Pedal Application Error** – an incident where a driver mistakenly presses the accelerator pedal instead of the brake pedal.
- **Retrofit** – fitment of the system to be assessed after the first registration of the vehicle. Installation is may be completed by the Vehicle ManufacturerOEM or an authorised fitter.
- **Test Service** – The organisation undertaking the testing and certifying the results to the Approval Authority.



- **VUT: Vehicle Under Test** – means a vehicle that is being tested to this protocol.

6 Test conditions

6.1 Test Track

Testing shall be conducted on solid-paved road surfaces, with only a small amount of surface moisture, ice or other environmental factors that could reduce surface adhesion permitted.

The road surface shall not contain any major irregularities such as large pot holes or cracks in the road surface that may affect the behaviour of the driver (e.g. forcing them to take avoiding action) or have a physical impact on them (e.g. disturbing their foot and body position by causing them to move around excessively in their seat).

There shall be no obstructions in front of or behind the VUT for a distance of 10m. There shall be an area of free space of 3m to either side of the VUT.

6.2 Weather and lighting

Testing shall be conducted in clear and dry weather conditions with no precipitation falling and temperatures no lower than 5°C and not higher than 40°C.

Testing shall be conducted in both daytime and night time lighting conditions:

- a) For daytime testing, natural ambient illumination shall be homogenous in the test area and in excess of 2000 lux. Testing shall not be performed driving towards, or away from the sun when there is direct sunlight.
- b) For night-time testing, natural ambient illumination shall be homogenous in the test area and should not be in excess of 20 lux.

7 Vehicle preparation

The VUT shall be prepared according to the following requirements:

The pedal application error systems shall have been installed during manufacture in the case of a new-build vehicle or retrofitted by qualified fitter authorised by the OEM; and

The VUT shall:

- a) Have passed a DVSA approved Periodic Technical Inspection within the last 12 months (if the vehicle is more than 12 months old) or passed an equivalent inspection if unregistered
- b) Be within its scheduled maintenance period (unless it is a new vehicle that has not yet been required to have its first service)
- c) Have no faults or damage that could interfere with the testing protocol
- d) Have a halt brake system the engages when the bus doors are opened and when the passenger ramp is lowered
- e) Be driven by a qualified driver



Be empty of passengers or any persons other than the driver.

8 Test procedure

8.1 BTS

Apply the BTS checklist as defined in Appendix A in the following sequence:

- a) Put the VUT into the specified state
- b) Observe the result
- c) Compare the observed result to required result
- d) Record if observed result matches required result (“Pass” or “Fail”)

8.2 ALS

Apply the ALS checklist as defined in Appendix B in the following sequence:

- a) Put the VUT into the specified state
- b) Observe the result
- c) Compare observed result to required result
- d) Record if observed result matches required result (“Pass” or “Fail”)

The assessment of the ALS shall be completed under the following lighting conditions:

- a) Daylight
- b) Night time.

See section 6.2 for definition of lighting conditions.

Apply the lamp installation/illumination checklist as defined in Appendix C

The speed of activation of the lamps shall be assessed using high speed video analysis.

- a) The frame rate for the video shall be at least 1000 frames per second.
- b) The high speed video shall be synchronised with the CAN signal from the pedals.

The delay between the first movement of the pedal and the lamp achieving 90% of its steady state output shall be recorded.

8.3 Pedal acoustic feedback

Apply the pedal acoustic feedback checklist as defined in Appendix D.

This test shall only apply for quiet running vehicles including a hybrid (HEV), pure electric (PEV), electrified vehicle (EV), fuel cell vehicle (FCV) or a fuel cell hybrid vehicle (FCHV) drivetrain.



9 Assessment of results

The following criteria will be used to assess if the BTS and ALS have passed or failed the assessment.

9.1.1 BTS

In order to receive a “Pass” certification the system must receive a “Pass” grade for each of the requirements on the assessment checklist.

The system shall be deemed to have failed the assessment if it received a single “Fail” grade on the BTS assessment checklist.

9.1.2 ALS

In order to receive a “Pass” certification the system must receive a “Pass” grade for each of the requirements on the assessment checklist.

The system shall be deemed to have failed the assessment if it received a single “Fail” grade on the ALS assessment checklist.

9.1.3 Lamp installation/illumination checklist

In order to receive a “Pass” certification the system must receive a “Pass” grade for each of the requirements on the assessment checklist.

The system shall be deemed to have failed the assessment if it received a single “Fail” grade on the assessment checklist.

The lamp activation time shall be 100ms or less.

9.1.4 Pedal acoustic feedback checklist

Evidence shall be submitted by the OEM, or a bus inspected. The test engineer shall assess whether the bus passes or fails each check.

9.1.5 Overall Assessment

In order to receive an overall “Pass” certification the system must receive a “Pass” grade for each of the above sections on the checklist and have a lamp activation time of 100ms or less.

The system shall receive an overall “Fail” grade in the assessment if a single “Fail” grade was awarded on any section of the assessment checklist or if the lamp activation time is more than 100ms.

To integrate this pass/fail test into the overall bus safety score an overall Pass will be deemed as a score of 100% and a fail will be deemed a score of 0%.

10 Test report

The Test Service shall provide a comprehensive test report that will be made available to the Approval Authority. The test report shall consist of the following distinct sections:



- a) Completed BTS checklist;
- b) Completed ALS checklist;
- c) Completed lamp installation/illumination checklist;
- d) Lamp activation assessment;
- e) Pedal acoustic feedback checklist; and
- f) Reference information.

The reference information required shall include as a minimum:

- a) Vehicle make;
- b) Vehicle model;
- c) Vehicle model variant;
- d) Pedal application error system installed (New-build/Retrofit);
- e) Evidence of meeting vehicle preparation requirements (e.g. MOT certificate, service history);
- f) Details of the Test Service; and
- g) Test date(s).



Appendix A - Brake toggle system checklist

Step	Bus State (On/Off)	Gear	Park Brake	Bus Doors	Action	Required Outcome	Actual Outcome	Outcome match? (Yes=1, No=0)
1	On	Drive	On	Closed	Open all bus doors	Halt brake engages		
2	On	Drive	Off	Closed	Apply accelerator	Halt brake remains engaged and bus does not move		
3	On	Drive	Off	Closed	Depress brake pedal to level that triggers brake lights on, and then release brake pedal	Bus remains stationary until the accelerator pedal is engaged. (The bus must not roll backwards. If the halt brake is released upon the depression of the brake pedal the vehicle must either remain stationary or roll forward at less than 1mph)		
4	On	Drive	Off	Closed	Apply accelerator	Bus moves forward		
5	On	Drive	On	Closed	Open all bus doors	Halt brake engages		
6	On	Drive	Off	Closed	Depress brake pedal to level that triggers brake lights on, and then release brake pedal	Bus remains stationary until the accelerator pedal is engaged. (The bus must not roll backwards. If the halt brake is released upon the depression of the brake pedal the vehicle must either remain stationary or roll forward at less than 1mph)		
Total Required Score Outcome								6



Appendix B - Accelerator light system checklist

Step	Bus State (On/Off)	Gear	Park Brake	Bus Doors	Action	Required Outcome	Actual Outcome	Outcome match? (Yes=1, No=0)
1	On	Drive	Off	Closed	Neither pedal pressed	Light is unlit when neither pedal is pressed		
2	On	Drive	Off	Closed	Brake pedal pressed	Light is unlit when brake pedal is pressed		
3	On	Drive	Off	Closed	Accelerator pedal pressed <80%	Light unlit		
4	On	Drive	Off	Closed	Accelerator pedal pressed >80%	No noticeable delay in light turning on		
5	On	Drive	Off	Closed	Accelerator pedal pressed >80%	Light illuminated		
6	On	Drive	Off	Closed	Accelerator pedal pressed <80%	No noticeable delay in light turning off		
7	On	Drive	Off	Closed	Accelerator pedal pressed >80%	No visible flickering of lights		
8	On	Drive	Off	Closed	Brake pedal pressed	No noticeable delay in light turning off		
9	Pn	Drive	Off	Closed	Accelerator pedal pressed	No noticeable delay in light illuminating		
Total Required Score Outcome								9



Appendix C - Lamp installation/illumination checklist

Step	Bus State (On/Off)	Gear	Park Brake	Bus Doors	Action	Required Outcome	Actual Outcome	Outcome match? (Yes=1, No=0)
1	On	Neutral	On	Closed	Accelerator pedal pressed	Lights meet requirements of UN Regulation 121 Sections 5.2.2 5.2.4 5.4.2 and 5.4.3		
2	On	Neutral	On	Closed	Accelerator pedal pressed	Lights meet requirements of ISO 2575:2004 Section 4 and Section 5		
3	On	Neutral	On	Closed	Accelerator pedal pressed	Lights meet UN ECE Regulation 121		
4	n/a	n/a	n/a	n/a	n/a	The light symbol is: 		
5	n/a	n/a	n/a	n/a	n/a	The icon must be displayed on a minimum pixel matrix of 32x32.		
6	n/a	n/a	n/a	n/a	n/a	The icon shall be yellow on a black background		
7	n/a	n/a	n/a	n/a	n/a	Text must be presented on a minimum character matrix of 7x9.		
8	n/a	n/a	n/a	n/a	n/a	The icon shall not flash or flicker.		
9	n/a	n/a	n/a	n/a	n/a	The font of the text is not specified but must be clearly legible (ISO 2575:2010+A7:2017).		

London Buses

New Bus Specification Version 2.0



10	n/a	n/a	n/a	n/a	n/a	Typefaces selected should be evenly and proportionately spaced.	
11	n/a	n/a	n/a	n/a	n/a	The space between vertical strokes (such as between l and m) should range between 150% and 240% of the character stem width.	
12	n/a	n/a	n/a	n/a	n/a	The space between diagonal characters and a vertical (such as between v and l) should be a minimum of 85% of the stem width	
13	n/a	n/a	n/a	n/a	n/a	Two diagonal characters should not touch.	
Total Required Score Outcome							13



Appendix D - Pedal acoustic feedback checklist

Acoustic feedback	Expected Outcome	Actual Outcome	Outcome match? (Yes=1, No=0)
The feedback system shall have a master volume control that can only be set by the OEM to prevent increasing the noise levels inside the saloon of the bus	Pass		
The level set by the OEM shall be audible by the driver and not cause undue annoyance. (Levels to be defined by testing using ISO 5128 - 1980 (E); Acoustics - Measurement of Noise inside Motor Vehicle).	Pass		
A local Driver volume control shall also be incorporated that will allow the driver to reduce the volume of the system to a pre-set minimum level (not to switch off) and also not increase the volume beyond the OEM's pre-set point.	Pass		
The feedback speaker(s) should be mounted behind the drivers head area at ear height.	Pass		
When installing/positioning the feedback speaker(s) care must be taken as to not have a detrimental effect on head movement during the operation of the bus and in the case of a collision the head being able to strike hard objects.	Pass		
Total Required Score Outcome			5



Attachment 27: Pedal Application Error

Guidance Notes

1 Introduction

This document sets out the guidance notes related to pedal application error. These guidance notes are aimed at bus operators and manufacturers as a practical guide for implementation of the Bus Safety Standard.

These notes are for guidance only, and are not legally binding. In all circumstances, the guidance provided by a manufacturer of the bus or system shall take precedence, and these guidance notes are only for use in the absence of other information. These are not intended to be exhaustive, but to point the operators toward practical advice and questions to raise with manufacturers/suppliers.

2 Selection of buses/systems

Any bus that meets the TfL Bus Vehicle Specification.

The Bus Safety Standard contains several systems intended to reduce the likelihood and consequence of errors in pedal choice between the brake and accelerator:

- Pedal toggling – a system in which the brake pedal must be fully depressed and released before moving off after closing the doors
- Accelerator light indicator– a system that gives the driver a visual indication of the accelerator pedal being pressed via a light on the dashboard
- Pedal acoustic feedback system – a system that gives the driver an audible cue as to the use of pedals and the change of acceleration of the bus, in order to help with recovery from a pedal confusion incident.

2.1 Brake toggling

2.1.1 *Bus selection*

In order for this system to be retrofitted onto buses, the buses must have a halt brake system that operates when the bus doors are opened (as well as when the passenger ramp is lowered). Therefore, vehicles with such a system should be procured.

2.1.2 *System Selection*

A brake toggling system that requires the driver to press the brake pedal in order to release the halt brake should be selected. The halt brake should only engage after the bus doors have been opened or the passenger ramp has been lowered, with the brake press to release the halt brake only intended to operate when drivers are



leaving bus stops or starting their shift. A comparison between the task order for the brake reminder system and standard bus operation is detailed in Table 27_1 below.

Table 27_1. Comparison of task order between standard operation and the brake toggle system

Standard Bus Task Order	Brake Toggle Task Order
Press brake	Press brake
Change gear to "D"	Change gear to "D"
Release brake	Release brake
-	Press brake
-	Release brake
Release park brake	Release park brake
Apply accelerator	Apply accelerator

2.2 Brake/accelerator indicator lights

2.2.1 Bus selection

It may be easier to integrate the accelerator light into buses with LCD screens on the dashboard.

2.2.2 System selection

The accelerator indicator light system should be designed in such a way that it conforms to UN ECE Regulation 121. This makes reference to ISO 2575:2004, which should be used as additional guidance if needed. If further guidance is still needed then the guidance set out in the NHTSA Human Factors Design Guidance For Driver Vehicle Interfaces (DOT HS 812 360) may be referenced as a third option. UN ECE Regulation 121 takes precedence in all cases.

The requirements for the design and installation of the accelerator light system are contained within the requirements of the EC Whole Vehicle Type Approval for any tell-tale or indicator fitted to passenger or goods vehicles. These are provided in UN ECE Regulation 121 - Uniform Provisions Concerning the Approval of: Vehicles with Regard to the Location and Identification of Hand Controls, Tell-tales and Indicators. Regulation 121 prescribes the location, identification, colour, and illumination of common controls as well as the requirements for access and visibility

The visual indicator showing the driver when the accelerator is pressed is not included within the list of common items or controls covered by the Regulation. Where a tell-tale or indicator for which the Regulation does not provide specific provisions is installed on a vehicle certain requirements shall be adhered to. These requirements, taken from Sections 5 and 6 of Regulation 121, are summarised below:

Identification:

- a) Where possible a symbol designated for the purpose in ISO 2575:2010 - Road vehicles — Symbols for controls, indicators and tell-tales, shall be used



- b) To identify a tell-tale or indicator not included in the Regulation or ISO 2575:2004 the manufacturer may use a symbol of its own conception. Such symbols may include internationally recognised alphabetic or numeric indications.
- c) Where a symbol is designed by a manufacturer the principles of Paragraph 4 of ISO 2575:2010 shall be followed.
- d) Any additional symbol used by the manufacturer shall not cause confusion with any symbol specified in the Regulation.

Colour:

- a) Indicators and tell-tales not included in the Regulation or ISO 2575:2010 may be of any colour chosen by the manufacturer, however, such colour shall not interfere with or mask the identification of any tell-tale, control, or indicator specified in the Regulation.
- b) The colour to be selected shall follow the guidelines specified in Paragraph 5 of ISO 2575:2010.
- c) Each symbol used for identification of tell-tale or indicator shall stand out clearly against the background.
- d) The accelerator light system selected must adhere to these criteria.

2.3 Pedal acoustic feedback

2.3.1 Bus selection

This system is only required on quiet running buses with a hybrid (HEV), pure electric (PEV), electrified vehicle (EV), fuel cell vehicle (FCV) or a fuel cell hybrid vehicle (FCHV) drivetrain.

2.3.2 System Selection

No prototype or production versions of this system yet exist. Consultation with the bus manufacturers and TfL is needed before selecting buses.

3 Training

Usage of the pedal confusion solutions will require the creation of a training course to teach drivers about the solutions and how they operate. If feasible schedules should minimise drivers experience of mix of vehicles with and without the system. The determination for whether or not a driver is able to safely use the systems shall be up to the discretion of the bus operator and any assessment criteria they decide upon.

3.1 Brake Toggle

As the brake toggle solution involves a change to the driving tasks that drivers will have been trained to undertake and may have used for extended periods of time, some form of training with the system will be necessary.



In order to train drivers to use the brake toggle solution, it is recommended that drivers are first given a set of written instructions that explain how the system operates. The drivers shall then be given an oral explanation of how the system works from an instructor who is experienced at using the system. The driver shall then be given the opportunity to practise driving the bus on a private road. The driver shall first practice moving the bus from a standstill, imitating letting passengers on and off the bus by opening the bus doors and lowering the passenger ramp. Once the driver is comfortable using the system, they shall be given the opportunity to drive the bus on public roads. Ideally they will drive their normal bus route, stopping at bus stops along the way to practise moving off with the new brake interlock.

The instructor shall be responsible for determining if the driver is able to use the system based on how many errors they make and how long it takes them to deactivate the halt brake and drive away from the bus stops. There shall also be a small written examination that asks the driver basic questions regarding the brake toggle system, what the driver needs to do to operate the system and how their driving tasks will differ from what they are used to as a result of the system.

3.2 Accelerator Light System

Drivers are to be trained with the accelerator light system in conjunction with the brake toggle system, with the same training protocol applied. As with the brake toggle system, written and oral instructions will be provided to drivers, who will then drive the bus on private and public roads in order to familiarise themselves with the system. The instructor will then determine if the driver is able to safely use the system based on the number of errors they make and the time it takes them to move off from bus stops. A short written examination will also be employed to determine how well the driver understands the system.

3.3 Pedal acoustic feedback

The training for this system can be integrated with the other systems as above, with the same training protocol applied.

4 Maintenance

Maintenance shall only be undertaken by authorised and qualified individuals using OEM approved procedures. Maintenance of the systems should be incorporated into the regular servicing schedules for the bus.

4.1 Brake Toggle

Maintenance of the brake toggle system consists of maintaining the software that controls the bus interlock system as well as the halt brake system.

The software that is responsible for operating the bus interlock system must be regularly checked as part of the regular vehicle service schedule. The software must be checked in order to see that the halt brake is only activated upon the opening of the bus doors or the lowering of the passenger ramp, and that the halt brake can only be released after the brake has been fully depressed. It must also be ensured that any software updates that are made to the bus do not alter the logic of the



interlock system by allowing the halt brake to activate and deactivate in an incorrect manner. In order to ensure that the brake toggle system works as intended, the halt brake itself must undergo regular checks as part of the service schedule for the bus.

A maintenance check for the brake toggle system should consist of checking that opening the bus doors and lowering the passenger ramp activates the halt brake, and that the halt brake cannot be deactivated without the brake pedal being fully depressed. A software check should also be carried out in order to ensure that the system is operating correctly.

4.2 Accelerator Light System

Maintenance of the accelerator light system should form part of the regular service schedule for the vehicle.

The light must be checked to see that there is no visible flicker when it illuminates and that there is no perceptible delay between the accelerator pedal being pressed and the corresponding lights activating. The light should also be checked to make sure that the correct colour is associated with the accelerator pedal press. A check should also be made to see that the light does not illuminate when neither of the pedals are being pressed. If the light is built into an LCD display then the software that operates the screen must be regularly checked. Visual inspections must also be carried out in order to ensure that there are no dead pixels or artefacts.

A maintenance check for the accelerator light system should consist of a visual inspection of the lights while the accelerator pedal is being pressed. A software check should also be carried out.

4.3 Pedal acoustic feedback system

Maintenance of the pedal acoustic feedback system should form part of the regular service schedule for the vehicle.

The speakers must be checked to see that there is no obscuration or damage, and to check that there is no perceptible delay between the accelerator pedal being pressed and the corresponding sound changing frequency. A check should also be made to listen for the sound changing frequency as the accelerator pedal is released, and that the sound remains constant if the pedal pressure is also constant.

5 Repair

Repairs shall only be undertaken by authorised and qualified individuals using OEM approved parts and procedures. If the systems were retrofitted then the guidelines set out by the post-homologation manufacturer shall be followed.

Advice should be sought from the manufacturers of the specific systems fitted to buses in service regarding precautions to be taken in the event of a system failure. However, as these systems are safety aids rather than safety critical systems for the bus, the failure of these systems should not normally render the bus unroadworthy. Repairs to the systems should be made as soon as operationally possible.



5.1 Brake Toggle

If a failure occurs to the brake toggle system due to a software error, then an appropriate software fix shall be implemented. The bus OEM (or post-homologation parts manufacturer in the case that the systems were retrofitted) should be consulted to diagnose the software fault and they shall then issue a fix to resolve the fault. The bus operator should not attempt to diagnose and fix the issue without consulting the bus OEM and seeking their assistance as incorrect software changes could affect the functioning of the halt brake.

Any faults that occur with halt brake system shall be repaired following the normal repair guidelines set out by the bus OEM.

5.2 Accelerator Light System

In the event that the accelerator light system becomes faulty due to a software issue then the bus OEM (or post-homologation parts manufacturer) should be consulted to diagnose the software fault and they shall then issue a fix to resolve the fault. Any physical issues with the lights shall be resolved by replacing the lights with approved parts. If the operation of dashboard lights fitted within an LCD screen is compromised due to some fault with the screen itself, e.g. dead pixels, poor contrast or brightness, then the bus OEM or supplier of the screen should be consulted for repair instructions.

5.3 Pedal acoustic feedback system

In the event that the pedal acoustic feedback system becomes faulty due to a software issue then the bus OEM (or post-homologation parts manufacturer) should be consulted to diagnose the software fault and they shall then issue a fix to resolve the fault. Any physical issues with the speakers shall be resolved by replacing the speakers with approved parts.



Attachment 28: Runaway Bus Prevention Assessment Protocol

1 Introduction

A Runaway Bus Prevention system is required for all buses in service in London to automatically stop the bus from moving from a stationary position in the event that a driver has left the driving seat without applying the park brake.

This document presents a procedure for objectively assessing the performance of systems installed on a bus to prevent the bus rolling in an uncontrolled manner without input from a driver; the occurrence of which would be known as a “runaway event” or “runaway bus”.

For full understanding of this Attachment it should be read in conjunction with the Attachment 29: Runaway Bus Prevention Guidance Notes and New Bus Specification, Section 4.3.11.

2 Scope

This protocol applies to all new buses intended for service under contract to TfL that are passenger vehicles with a maximum mass exceeding 5 tonnes and a capacity exceeding 22 passengers. The passenger vehicles will be capable of carrying seated but unrestrained occupants and standing occupants. Such vehicles are categorised the Consolidated Resolution on the Construction of Vehicles (R.E.3) as M₃; Class I, Class II.

3 Purpose

The purpose of this protocol is to allow an assessment against the required level of performance for systems that claim to prevent runaway bus occurrences.

4 Normative References

The following normative documents, in whole or in part, are referenced in this document and are indispensable for its correct application. For dated references, only the edition cited applies. For undated references, the latest edition of the referenced document (including any amendments) applies.

- London Bus Services Limited New Bus Specification: Section 4.3.11
- London Bus Services Limited New Bus Specification: Attachment 29 Runaway Bus Prevention Guidance Notes



5 Definitions

For the purpose of this Protocol:

- **Approval Authority** – The body within TfL that certifies that a bus is approved for use in the TfL fleet and assigns its score under the Bus Safety Standard for use in procurement processes
- **Halt Brake** – An automated braking system that prevents a bus from moving under certain conditions (e.g. when the bus doors are open or the bus ramp is lowered)
- **New Build** – A vehicle that has been built by the OEM with the system to be assessed fitted during the assembly process prior to first registration of the vehicle
- **Park Brake** – Brake system that is intended to keep the vehicle stationary when parked
- **RaB: Runaway Bus** – A bus without the park brake engaged that moves in any direction in an uncontrolled manner without any input from a driver
- **Test Service** – The organisation undertaking the testing and certifying the results to the Approval Authority
- **VUT: Vehicle Under Test** – The vehicle tested according to this protocol

6 Test conditions

6.1 Test track

Testing shall be conducted on dry (no surface moisture, ice or other environmental factors that could reduce surface adhesion) and solid-paved road surfaces.

The test track shall have a gradient of between 1% and a 5%.

A clear zone shall be defined around the VUT. The clear zone shall extend at least one bus length in front and one bus length behind the VUT, and one bus width to either side of the VUT. This is to give sufficient room for any rolling that occurs as a result of the testing.

6.2 Weather and lighting

Testing shall be conducted in clear and dry weather conditions with no precipitation falling and temperatures no lower than 5°C and not higher than 40°C. As an alternative the tests may be conducted indoors.

The test track shall have a level of ambient light that will allow the driver and assessor to see if any people or objects move into positions where they could be at risk of being hit by the bus during testing.



7 Vehicle preparation

The RaB bus preventions system shall:

- a) Have been installed during manufacture in the case of a new-build vehicle
- b) Interact with the park brake and not the halt brake to ensure system functionality in the event that the halt brake has no air pressure in it (whether through a malfunction or because the bus is switched off and the brake pressure has released)

The VUT shall:

- a) Have passed its mandatory Periodic Technical Inspection at a DVSA approved facility within the last 12 months (if the vehicle is more than 12 months old), with the exception of prototype vehicles
- b) Be within its scheduled maintenance period (unless it is a new vehicle that has not yet been required to have its first service)
- c) Have no faults or damage that could interfere with the testing protocol. The brakes shall have been checked by the driver to ensure that the bus can be stopped manually during testing in the event that the bus does roll
- d) Have a halt brake system the engages when the bus doors are opened and when the passenger ramp is lowered
- e) Have checked all passenger doors on the ground floor to ensure they are all fully operational
- f) Be positioned on the test track of defined gradient to ensure that if the bus is not being held stationary by any mechanisms it will visibly roll in a way that is obvious to the assessor
- g) Have no obstructions in front or behind any of its wheels
- h) Be driven by a qualified driver. In the instances where the test procedure requires there be no seat pressure the driver shall remain within the drivers cabin to apply the brakes when the bus rolls
- i) Be empty of passengers or any persons other than the driver

8 Test procedure

The assessment of the RaB prevention system is carried out in two stages. The Park Brake system checklist shall be completed prior to commencing the RaB prevention system checklist.

Assessments shall conducted and recorded with the vehicle oriented such that the gradient is positive. These shall then be repeated with the vehicle orientation reversed, resulting in a negative gradient.

8.1 Park Brake system checklist

Apply the Park Brake system checklist as defined in Appendix A in the following sequence:

- a) Put the VUT into the specified state



- b) Observe the result
- c) Compare the observed result to the required result
- d) Record if observed result matches required result (“Pass” or “Fail”)
- e) Reset the position of the VUT if it has moved during the test
- f) Reset the gear to neutral

8.2 RaB prevention system checklist

Only if all requirements of the Park Brake system checklist are satisfied shall the testing continue. Apply the RaB prevention system checklist as defined in Appendix B in the following sequence:

- a) Put the VUT into the specified state
- b) Observe the result
- c) Compare the observed result to the required result
- d) Record if observed result matches required result (“Pass” or “Fail”)
- e) Reset the position of the VUT if it has moved during the test
- f) Reset the gear to neutral

9 Assessment of results

The following criteria will be used to assess if the RaB prevention system has passed or failed the assessment.

The Park Brake system and the RaB prevention system tested using a positive and a negative gradient

9.1 Assessment of the Park Brake System

- a) In order to receive a “Pass” certification the system must meet the expected outcome when tested using a positive and negative gradient, for each of the requirements on the Park Brake system assessment checklist, Appendix A.
- b) The system shall be deemed to have failed the assessment if it does not meet any single expected outcome on the Park Brake system assessment checklist.

9.2 Assessment of the RaB prevention system

- a) In order to receive a “Pass” certification the system must meet the expected outcome when tested using a positive and negative gradient, for each of the requirements on the Runaway Bus prevention system checklist, Appendix B.
- b) The system shall be deemed to have failed the assessment if it does not meet any single expected outcome on the Runaway Bus prevention system checklist.



9.3 Overall Assessment

- a) In order to receive an overall “Pass” certification the system must receive a “Pass” grade for each assessment.
- b) To integrate this pass/fail test into the overall bus safety score an overall Pass will be deemed as a score of 100% and a fail will be deemed a score of 0%
- c) A system that fails to meet these pre-requisites shall not be recommended

10 Test report

The Test Service shall provide a comprehensive test report that will be made available to the Approval Authority. The test report shall consist of three distinct sections:

- a) Completed Park Brake system checklist
- b) Completed RaB prevention system checklist
- c) Vehicle Reference information

The reference information required shall include as a minimum:

- i. Vehicle Make
- ii. Vehicle Model
- iii. Vehicle Model Variant
- iv. RaB system installed
- v. Evidence of meeting vehicle preparation requirements (e.g. MOT certificate, service history)
- vi. Details of the Test Service
- vii. Test date(s)



Appendix A - Park Brake system checklist

Runaway Bus Prevention POSTIVE GRADIENT			General Braking Mechanisms		Break Down	Expected Outcome	Actual Outcome	Outcome match? (Yes=1, No=0)
Drive enabled (Is the bus "on"?)	Gear	Seat Pressure / Driver Input	Park Brake	Passenger Door	Kill Switch			
No	Neutral	Yes	Off	Closed	Disengaged	Roll		
No	Neutral	Yes	On	Closed	Disengaged	No roll		
No	Neutral	No	Off	Closed	Engage	Roll		
Yes	Neutral	Yes	Off	Closed	Disengaged	Roll		
Yes	Neutral	Yes	On	Closed	Disengaged	No roll		
Yes	Neutral	No	Off	Closed	Engage	Roll		
Yes	Reverse	Yes	Off	Closed	Disengaged	Roll		
Yes	Reverse	Yes	On	Closed	Disengaged	No roll		
Yes	Reverse	No	Off	Closed	Engage	Roll		
Yes	Drive	Yes	Off	Closed	Disengaged	Roll		
Yes	Drive	Yes	On	Closed	Disengaged	No roll		
Yes	Drive	No	Off	Closed	Engage	Roll		
						Total Required Score Outcome		12



Runaway Bus Prevention NEGATIVE GRADIENT			General Braking Mechanisms		Break Down	Expected Outcome	Actual Outcome	Outcome match? (Yes=1, No=0)
Drive enabled (Is the bus "on"?)	Gear	Seat Pressure / Driver Input	Park Brake	Passenger Door	Kill Switch			
No	Neutral	Yes	Off	Closed	Disengaged	Roll		
No	Neutral	Yes	On	Closed	Disengaged	No roll		
No	Neutral	No	Off	Closed	Engage	Roll		
Yes	Neutral	Yes	Off	Closed	Disengaged	Roll		
Yes	Neutral	Yes	On	Closed	Disengaged	No roll		
Yes	Neutral	No	Off	Closed	Engage	Roll		
Yes	Reverse	Yes	Off	Closed	Disengaged	Roll		
Yes	Reverse	Yes	On	Closed	Disengaged	No roll		
Yes	Reverse	No	Off	Closed	Engage	Roll		
Yes	Drive	Yes	Off	Closed	Disengaged	Roll		
Yes	Drive	Yes	On	Closed	Disengaged	No roll		
Yes	Drive	No	Off	Closed	Engage	Roll		
Total Required Score Outcome								12



Appendix B - Runaway bus prevention system checklist

Runaway Bus Prevention POSITIVE GRADIENT			General Braking Mechanisms		Expected Outcome	Actual Outcome	Outcome match? (Yes=1, No=0)
Drive enabled (Is the bus "on"?)	Gear	Seat Pressure / Driver Input	Park Brake	Passenger Door			
No	Neutral	Yes	Off	Open	No roll		
No	Neutral	No	Off	Closed	No roll		
No	Neutral	Yes	Off	Closed	Roll		
Yes	Neutral	Yes	Off	Open	No roll		
Yes	Neutral	No	Off	Closed	No roll		
Yes	Neutral	Yes	Off	Closed	Roll		
Yes	Reverse	Yes	Off	Open	No roll		
Yes	Reverse	No	Off	Closed	No roll		
Yes	Reverse	Yes	Off	Closed	Roll		
Yes	Drive	Yes	Off	Open	No roll		
Yes	Drive	No	Off	Closed	No roll		
Yes	Drive	Yes	Off	Closed	Roll		
Total Required Score Outcome						12	



Runaway Bus Prevention NEGATIVE GRADIENT			General Braking Mechanisms		Expected Outcome	Actual Outcome	Outcome match? (Yes=1, No=0)
Drive enabled (Is the bus "on"?)	Gear	Seat Pressure / Driver Input	Park Brake	Passenger Door			
No	Neutral	Yes	Off	Open	No roll		
No	Neutral	No	Off	Closed	No roll		
No	Neutral	Yes	Off	Closed	Roll		
Yes	Neutral	Yes	Off	Open	No roll		
Yes	Neutral	No	Off	Closed	No roll		
Yes	Neutral	Yes	Off	Closed	Roll		
Yes	Reverse	Yes	Off	Open	No roll		
Yes	Reverse	No	Off	Closed	No roll		
Yes	Reverse	Yes	Off	Closed	Roll		
Yes	Drive	Yes	Off	Open	No roll		
Yes	Drive	No	Off	Closed	No roll		
Yes	Drive	Yes	Off	Closed	Roll		
Total Required Score Outcome							12



Attachment 29: Runaway Bus Prevention Guidance Notes

1 Introduction

A Runaway Bus Prevention system is required for all buses in service in London to automatically stop the bus from moving from a stationary position in the event that a driver has left the driving seat without applying the park brake.

This document sets out the guidance notes related to runaway bus prevention. These guidance notes are aimed at bus operators and Original Equipment Manufacturers (OEM) as a practical guide for implementation of the Bus Safety Standard.

These notes are for guidance only, and are not legally binding. In all circumstances, the guidance provided by an OEM of the bus or system shall take precedence, and these guidance notes are only for use in the absence of other information. These are not intended to be exhaustive, but to point the operators toward practical advice and questions to raise with OEMs/suppliers.

2 Selection of buses/test services

Any bus that meets the TfL Bus Vehicle Specification.

An assessment of the runaway bus prevention system may be conducted using a new build bus.

The testing of the runaway prevention should be carried out by a TfL approved test service. In the case that testing is to be carried out by a test house that does not fall into the aforementioned category prior approval must be gained from TfL.

2.1 Compliance and warranty

A bus operator should ask to see compliance certificates for UNECE Regulation 13 and warranty information for the brake system from both the bus OEM and/or the system supplier. The bus operator must be able to present certificates to TfL as evidence that the bus brake system will continue to operate safely, and that the bus will not brake unexpectedly whilst in motion.

A bus OEM should work with any brake or runaway bus prevention system suppliers to ensure that UNECE Regulation 13 requirements are met, and that warranty on the brake system is maintained. The bus OEM must be able to present certificates to TfL as evidence that the bus brake system will continue to operate safely, and that the bus will not brake unexpectedly whilst in motion.



In the case that there are any functional changes made to the bus the vehicle should be re-tested (at the discretion of TfL) to make sure it still complies with the runaway bus assessment protocol.

2.2 Towing and recovery

The runaway bus prevention system is designed to keep the bus brakes on. Towing and recovery are the exceptions to this requirement and the bus needs to be able to roll without the driver in the seat.

UNECE Regulation 13 requires an auxiliary release system for the brakes to allow towing. These are often mechanical. Auxiliary release is only intended for use in full breakdown/recovery circumstances and should only be undertaken when the vehicle is held stationary by some other external means, e.g. wheel chocks or recovery vehicles etc.. The Regulation permits powered auxiliary release systems but only if the energy source is different to that used by the brakes, e.g. it can't be operated from the same air supply such that the loss causing the problem also causes the release not to work. Bus drivers should be trained on how to use the auxiliary release.

3 Training

3.1 Bus drivers

The runaway bus prevention systems are aimed at reducing the risk associated with the rare occurrences where the park brake has not been applied. The drivers don't necessarily need to be trained in exactly how the system works but do need to be informed that it will trigger in instances where the bus has been left vulnerable to rolling (without the park brake engaged). Drivers do however need to be trained in how to release the system once they have rectified the issue by engaging the park brake.

3.2 Shift Supervisors

Shift supervisors should be trained in how the system works and know the code/sequence of actions to activate the Runaway Bus Prevention system's auxiliary release.

In the event that the system has been engaged and the driver or engineer is not able to release it, the shift supervisor shall have ability to rectify the situation.

3.3 Bus maintenance engineers

The engineers carrying out general bus maintenance should be aware of how to activate the auxiliary release on the runaway prevention system, should the maintenance they are carrying out require the bus to roll whilst in a state where the runaway prevention system would otherwise inhibit that movement.



4 Maintenance

The supplier of the Runaway Bus Prevention System or the vehicle OEM are required to provide the operator with suitable instructions and schedules for required checks and maintenance activities.

Operators are to ensure instructions and schedules provided by the system supplier or OEM are incorporated into the vehicle maintenance plans along with any associated costs.

5 Repair

If during system maintenance checks (Section 4) any of the sensors are deemed to be faulty or failing they must be replaced immediately. The runaway prevention system's effectiveness and reliability is completely contingent on the performance of the sensors the system is connected to.



Attachment 30: Acoustic Conspicuity

Assessment Protocol

1 Introduction

This document presents a procedure for objectively assessing the performance of Acoustic Vehicle Alerting Systems (AVAS) installed on a bus. TfL has designed a unique Urban Bus Sound to be used by quiet running buses in London and buses belonging to other organisations at TfL's discretion. The aim of these systems is to make a vehicle fitted with a quiet running powertrain (e.g. hybrid or electric) as conspicuous to a pedestrian as a typical diesel engine.

For full understanding of this Attachment it should be read in conjunction with the Attachment 31: Acoustic Conspicuity Guidance Notes and New Bus Specification, Section 4.4.1.

2 Scope

This protocol applies to all new buses intended for service under contract to TfL that are passenger vehicles with a maximum mass exceeding 5 tonnes and a capacity exceeding 22 passengers. The passenger vehicles will be capable of carrying seated but unrestrained occupants and standing occupants. Such vehicles are categorised the Consolidated Resolution on the Construction of Vehicles (R.E.3) as M₃; Class I, Class II.

UNECE Regulation 138 requires the addition of an Acoustic Vehicle Alerting System (AVAS) on all new quiet running vehicles. The regulation came into effect for all new vehicle models of this type manufactured after 01/07/2019 and applies to all vehicles manufactured after 01/07/2021.

3 Purpose

The purpose of this protocol is to allow an assessment against the required level of performance for Acoustic Vehicle Alerting Systems (AVAS).

4 Normative References

The following normative documents, in whole or in part, are referenced in this document and are indispensable for its correct application. For dated references, only the edition cited applies. For undated references, the latest edition of the referenced document (including any amendments) applies.

- London Bus Services Limited New Bus Specification: Section 4.4.1
- London Bus Services Limited New Bus Specification: Attachment 31 Acoustic Conspicuity Guidance Notes



- UN ECE Regulation 138; Uniform provisions concerning the approval of Quiet Road Transport Vehicles with regard to their reduced audibility

5 Definitions

For the purpose of this Protocol:

- **Approval Authority** – The body within TfL that certifies that a bus is approved for use in the TfL fleet and assigns its score under the Bus Safety Standard for use in procurement processes.
- **AVAS** – Acoustic Vehicle Alerting System. This is the entire system including both hardware & firmware/software and the Urban Bus Sound when installed on a bus, as per Regulation 138.
- **AVAS Hardware** - Complete playback system used to reproduce the AVAS
- **Beacon sound** - Part of the Urban Bus Sound. A Distinct rhythmic pulse, intended to raise acoustic conspicuity
- **Core sound** - Part of the Urban Bus Sound. An underlying sound component that is played continuously when the bus is in operation
- **Front plane of the vehicle** - A vertical plane tangential to the leading edge of the vehicle
- **Intelligent Speed Assistance (ISA)** - Through TfL Digital Speed Map bus selects localised speed limits
- **L_{AMAX, FAST}** - The maximum sound pressure in a 5 second period, A-weighted, Fast time weighting
- **New Build** – A vehicle that has been built by the Vehicle OEM with the system to be assessed fitted during the assembly process prior to first registration of the vehicle.
- **Quiet running vehicle** - Any vehicle which does not require the continuous operation of an internal combustion engine to propel the vehicle
- **Rear plane of the vehicle** - A vertical plane tangential to the trailing edge of the vehicle
- **Sound Pressure Level (L_{pA})** - The sound pressure expressed in Decibels, A-weighted
- **Test Service** – The organisation undertaking the testing and certifying the results to the Approval Authority.
- **Urban Bus Sound** - The uniquely identifiable AVAS sound designed and owned by TfL, consists of two components
- **VUT: Vehicle Under Test** – Means a vehicle that is being tested to this protocol.



6 Test Conditions

Requirements for testing as defined in Regulation 138.

6.1 Test Track (Outdoors)

Testing shall be conducted on a dry surface, free from absorbing materials (powdery snow, or loose debris)

The test track shall meet the requirements of ISO 10844:2014.

6.2 Test Track (Indoors)

The test facility shall meet the requirements of ISO 26101:2012.

6.3 Weather and lighting

Testing shall be conducted in dry weather conditions with no precipitation falling and temperatures no lower than 5°C and not higher than 40°C.

Wind speed shall be less than 5 m/s. As an alternative the tests may be conducted indoors.

The test track shall have a level of ambient light that will allow the driver and assessor to see if any people or objects move into positions where they could be a risk of being hit by the bus during testing.

7 Vehicle preparation

The AVAS shall have been installed during manufacture in the case of a new-build vehicle.

The VUT shall:

- a) Have passed an annual MOT test at a DVSA test station within the last 12 months (if the vehicle is more than 12 months old), with the exception of prototype vehicles
- b) Be within its scheduled maintenance period (unless it is a new vehicle that has not yet been required to have its first service)
- c) Have no faults or damage that could interfere with the testing protocol
- d) Be driven by a qualified driver. In the instances where the test procedure requires there be no seat pressure the driver shall remain within the drivers cabin to apply the brakes when the bus rolls
- e) Be empty of passengers or any persons other than the driver

8 Test procedure

The assessment of the AVAS is carried out using the checklists found in Appendix A and B.

The AVAS checklist shall be assessed based on documentation submitted by the bus OEM.



Testing of the AVAS shall be conducted in a manner conforming to UN ECE Regulation 138.

All observed results shall be recorded in the checklist.

9 Assessment of results

The following criteria will be used to assess if the AVAS system has passed or failed the assessment.

In order to receive a “Pass” certification, the system must meet the expected outcome for each of the requirements on the assessment checklist.

The system shall be deemed to have failed the assessment if it does not meet any single expected outcome on the AVAS assessment checklist. A system that fails to meet these pre-requisites shall not be recommended

10 Test report

The Test Service shall provide a comprehensive test report that will be made available to the Approval Authority. The test report shall consist of two distinct sections:

- a) Completed AVAS checklist;
- b) Reference information.

The reference information required shall include as a minimum:

- a) Vehicle Make
- b) Vehicle Model
- c) Vehicle Model Variant
- d) AVAS system installed
- e) Evidence of meeting vehicle preparation requirements (e.g. technical inspection, service history)
- f) Details of the Test Service
- g) Test date(s)



Appendix A - AVAS checklist

Acoustic Vehicle Alerting System (AVAS)	Expected Outcome	Actual Outcome	Outcome match? (Yes=1, No=0)
System shall be comprise of a 2 channels with separate directional speakers	True		
Speaker mounts: Horizontal plane - Up to a maximum [0.6]m either side of the longitudinal centre line of the bus	True		
Speaker mounts: Vertical plane – Height from the ground plane of between [0.5]m and [1.0]m (<i>Note: Normally [0.8 m]</i>)	True		
The speakers are mounted one on each side of the bus front longitudinal centre line	True		
Each speaker has a horizontal beam width/directivity pattern in the range [120] ^o to [140] ^o and a vertical beam width/directivity pattern in the range [70] ^o to [110] ^o	True		
The centre line of the each speakers shall be is aligned towards the nearside kerb at an angle of between [20] ^o to and [30] ^o from the front surface of the buscentre line of the bus	True		
Where the two speakers are playing the same sound, the sound is incoherent to avoid interference patterns affecting conspicuity.	True		
AVAS sound is Regulation 138 compliant and a valid test certificate submitted	True		
TfL Urban bus sound, version 1.0 installed	True		
AVAS is capable of receiving an updated sound file in the future, e.g. as a minimum locally via USB, or optionally via telematics (mass update).	True		
A USB device must also be incorporated into the AVAS to allow for local updates.	True		
The system has the capability to have at least 3 or more sounds stored on the system (one sound at installation / entry into service, then a further two additional sounds)	3 or more True		
Total			
Required Score			13
Outcome			



Appendix B - AVAS Sound Level Requirements

Frequency (Hz)		Sound Pressure Level (dB(A))	
		Minimum	Maximum
Overall amplitude		50	72
1/3 Octave bands	160		
	200		
	250		
	315		
	400		
	500		
	630		
	800		
	1,000		
	1,250		
	1,600		
	2,000		
	2,500		
	3,150		
	4,000		
5,000			



Attachment 31: Acoustic Conspicuity

Guidance Notes

1 Introduction

This document sets out the guidance notes related to Acoustic Conspicuity. These guidance notes are aimed at bus operators and manufacturers as a practical guide for implementation of the Bus Safety Standard.

These notes are for guidance only, and are not legally binding. In all circumstances, the guidance provided by a manufacturer of the bus or system shall take precedence, and these guidance notes are only for use in the absence of other information. These are not intended to be exhaustive, but to point the operators toward practical advice and questions to raise with manufacturers/suppliers.

2 Selection of buses/systems

2.1 Buses requiring Acoustic Conspicuity measures

Regulatory requirements are in force for Whole Vehicle Type Approval (WVTA), in the form of Regulation 138¹. This requires:

- From September 2019 all new bus models (new designs requiring type approval) in vehicle category M2 or M3 and fitted with either a hybrid (HEV), pure electric (PEV), electrified vehicle (EV), fuel cell vehicle (FCV) or a fuel cell hybrid vehicle (FCHV) drivetrain will be subject to having acoustic conspicuity measures installed.
- From September 2022 all new registered buses with drivetrains listed above will also be subject to having acoustic conspicuity measures installed.

TfL requires all new buses conforming to the description above, to have an Acoustic Vehicle Alerting System (AVAS) installed in accordance with Regulation 138.

In particular the AVAS shall additionally meet some extra requirements, mainly around ability to emit the urban bus sound being designed by TfL, and that the noise should be updatable in the future.

2.2 Acoustic Conspicuity measure

2.2.1 AVAS (Acoustic Vehicle Alerting System)

A solution has been defined as 'added sound', or what is currently referred to as an AVAS (Acoustic Vehicle Alerting System). This is an audible warning, active at low speed, indicating steady state acceleration and deceleration conditions. Currently, systems meeting Regulation 138 are required to active at speeds between 0 km/h to

¹ UN ECE Regulation 138; Uniform provisions concerning the approval of Quiet Road Transport Vehicles with regard to their reduced audibility.



20 km/h inclusive, and are intended to replace engine noise cues to pedestrians and vulnerable road users (VRUs) that a vehicle is approaching.

A two channel AVAS should be selected. This will enable the sound sources to provide a fuller directional component towards the kerbside. The sound sources should be installed at the front of the bus (see Bus specification 4.4.1 for details of source height and direction). This should also be done in conjunction with the manufacturer of the AVAS equipment

TfL have developed a specific sound file for use on a 2 channel AVAS which the vehicle will be required to generate, known as the Urban Bus Sound (UBS). Availability of the UBS will be provided by TfL upon request.

Vehicle using AVAS shall be shown to be compliant with UNECE Regulation 138 (Uniform provisions concerning the approval of Quiet Road Transport Vehicles with regard to their reduced audibility - QRTV). Regulation 138 lays out the requirements for the minimum sound and defines the testing protocol.

The pace/playback speed and frequency content of the Urban Bus Sound must increase and decrease as the bus accelerates and decelerates, at a rate of 0.8% per km/h.

3 Training

Once AVAS equipment is installed, there should be very little training required as the system is automatic and will operate between set speeds and adjust the sound for acceleration and deceleration via inputs from the CAN-Bus. However, individual manufacturers of the equipment will advise if any training is required.

4 Maintenance

Once AVAS equipment is installed, there should be minimal maintenance required. However, as the system will be fitted within the front of the bus, regular inspection of the sound sources is recommended to keep them free of debris and to ensure that no damage has occurred.

Individual manufacturers of the equipment will advise if and what maintenance is required and will specify maintenance intervals.

5 Repair

Any repairs that are required to the AVAS will need to be done in conjunction with the manufacturer of the equipment



Attachment 32: Slip Prevention

Assessment Protocol

1 Introduction

To reduce the risk to occupants of slips or falls whilst travelling the floor of all buses in service in London will be expected to be covered with materials which provide an effective level of resistance to slip.

This document presents a procedure for the characterisation of the slip resistance properties of flooring materials for buses.

For full understanding of this Attachment it should be read in conjunction with the Attachment 33: Slip Prevention Guidance Notes and New Bus Specification, Section 4.5.6.

2 Scope

This protocol applies to all new buses intended for service under contract to TfL that are passenger vehicles with a maximum mass exceeding 5 tonnes and a capacity exceeding 22 passengers. The passenger vehicles will be capable of carrying seated but unrestrained occupants and standing occupants. Such vehicles are categorised the Consolidated Resolution on the Construction of Vehicles (R.E.3) as M₃; Class I, Class II.

3 Purpose

The purpose of this assessment is to characterise the slip risk associated with bus flooring materials by measuring and assessing the slip resistance of those materials. This is achieved by using a method adapted from the United Kingdom Slip Resistance Group (UKSRG) guidelines (The UK Slip Resistance Group, 2016) which uses the Portable Slip Resistance Tester (PSRT) as the measurement device.

4 Normative References

The following normative documents, in whole or in part, are referenced in this document and are indispensable for its correct application. For dated references, only the edition cited applies. For undated references, the latest edition of the referenced document (including any amendments) applies.

- London Bus Services Limited New Bus Specification: Section 4.5.6
- London Bus Services Limited New Bus Specification: Attachment 32 Slip Prevention Guidance Notes
- British Standards Institution. (2002). *BS 7976-2:2002 Pendulum testers - Part 2: Method of operation*. London: BSi.



- British Standards Institution. (2011). *BS EN 13036-4. Road and airfield surface characteristics. Test methods. Method for measurement of slip/skid resistance of a surface. The pendulum test.* London: BSi.
- British Standards Institution. (2013). *BS 7976-1:2002+A1:2013 Pendulum testers - Part 1: Specification.* London: BSi.
- British Standards Institution. (2013). *BS 7976-3:2002+A1:2013 Pendulum testers - method of calibration.* London: BSi.
- The UK Slip Resistance Group. (2016). *The assessment of floor slip resistance - The UK slip resistance group guidelines.* UKSRG.

5 Definitions

For the purpose of this Protocol:

- **Approval Authority** – The body within TfL that certifies that a bus is approved for use in the TfL fleet and assigns its score under the Bus Safety Standard for use in procurement processes.
- **IRHD: International Rubber Hardness Degrees** – Method for measuring the hardness of rubber.
- **PSRT: Portable Slip Resistance Tester** – Standard laboratory testing device for measuring slip resistance in the UK, defined by British Standards.
- **PTV: Pendulum Test Value** – Measurement recorded by the PSRT
- **UKAS: United Kingdom Accreditation Service** – The UK's national accreditation body.
- **UKSRG: United Kingdom Slip Resistance Group** – Independent authority of slip resistance.
- **Test Service** – The organisation undertaking the testing and certifying the results to the Approval Authority.
- **VUT: Vehicle Under Test** – Means a vehicle that is being tested to this protocol.

6 Test equipment and conditions

6.1 Test equipment

The measurement device used in this protocol is the PSRT as defined by the following British Standards:

- BS 7976-1:2002+A1:2013 (British Standards Institution, 2013)
- BS 7976-2:2002 (British Standards Institution, 2002)
- BS 7976-1:2003+A1:2013 (British Standards Institution, 2013)



6.2 Test conditions

All tests shall be completed in a test environment where the temperature is between 5°C to 40°C. This requirement is in addition to UKSRG guidelines (The UK Slip Resistance Group, 2016).

Tests shall only be made under wet conditions, having a thin, consistent film of water covering the entirety of the test area. This requirement supersedes Section 3.6 of the UKSRG guidelines (The UK Slip Resistance Group, 2016).

7 Test samples

Testing may be conducted at various levels of wear or aging for continued life assessment. Definition of the level of wear, stated as number of passengers, and age of the material shall be provided to the test service along with the sample/s.

Ideally the assessment of materials will be carried out on in-service vehicles however, should this not be possible, testing may be conducted upon representative material coupons within a laboratory. Testing shall be conducted following the procedure stated in section 8 for either In-vehicle or Laboratory testing.

- a) In-vehicle: Testing of the floor covering shall be performed at a number of locations. These should include, but are not limited to; the area inside the front door, the area inside any other passenger doors located down the body, the wheelchair area, the bottom of the stairs (double-deck vehicles), and any areas where passengers may stand on or travel over.
- b) Materials laboratory: Testing shall be performed using representative coupons of the floor covering material. The coupon size should be as specified by the test machine manufacturer.

8 Test procedure

The following procedure shall apply to measurements taken either using an in-service vehicle or material coupons within a laboratory.

Apply the UKSRG guidelines for measuring slip resistance using the PSRT, with the following amendments:

Tests shall be carried out within a test environment with a temperature range of 5°C to 40°C. (Addition to UKSRG guidelines (The UK Slip Resistance Group, 2016))

Tests shall only be made under wet conditions where a thin, consistent film of water covers the entirety of the test area. (Supersedes Section 3.6 of the UKSRG guidelines (The UK Slip Resistance Group, 2016))

Where possible testing of each in-vehicle location / coupon shall be conducted at three angles relative to the vehicle longitudinal axis. These are:

- 0° (Longitudinal axis)
- 90° (Lateral axis)
- 45°



Due to vehicle design and size of the test equipment there may not be room for all three angles to be tested. In which case testing should be taken as close to the test location as possible with the intention to test in 45° increments.

Photographic evidence and written description of each test location should be recorded at the time of test.

Each measurement shall be repeated until the range for five consecutive PTV measurements is less than or equal to 3.0. The mean of these 5 consecutive measurements shall be given as the Mean PTV. (This Supersedes Section 3.6, Point 9 and 10 of the UKSRG guidelines (The UK Slip Resistance Group, 2016)).

For clarity, Table 32_1 shows an example test matrix.

Table 32_1: Example test matrix for supplied specimens

Test location/coupon	Test direction (degrees)	PTV for test number:										Mean PTV	
		1	2	3	4	5	6	7	8	...	n		
1	0	45	52	50	49	51	48	49					49.4
	45												
	90												

9 Assessment of results

For all test locations / coupons the 'Mean PTV' calculated for each direction shall be assessed dependent upon the samples level of usage and age.

The level of slip shall be deemed a failure if any of the 'Mean PTV' values are found to be less than those stated in Table 32_2.

Table 32_2: Minimum 'Mean PTV' requirements

Usage	Age	PTV
New	New	36.0
Greater than 100,000 Passengers	Greater than 6 months	40.0

10 Test report

The Test Service shall provide a comprehensive test report which contains UKAS test certificates for testing performed. The following should also be provided as appropriate:

- a) Material definition, including trade name
- b) The vehicle details on which the assessed material was installed Test conditions
- c) Coupon batch of manufacture for material



- d) An approximation of the number of passengers transported by the vehicle at assessment stage
- e) The amount of time that the flooring material type was in service for at assessment stage
- f) Mean PTV values
- g) Pass/Fail assessment



Attachment 33: Slip Prevention

Guidance Notes

1 Introduction

To reduce the risk to occupants of slips or falls whilst travelling the floor of all buses in service in London will be expected to be covered with materials which provide an effective level of resistance to slip.

This document sets out the guidance notes related to flooring materials. These guidance notes are aimed at bus operators and manufacturers as a practical guide for implementation of the Bus Safety Standard.

These notes are for guidance only, and are not legally binding. In all circumstances, the guidance provided by a manufacturer of the bus or system shall take precedence, and these guidance notes are only for use in the absence of other information. These are not intended to be exhaustive, but to point the operators toward practical advice and questions to raise with manufacturers/suppliers.

2 Selection of buses/systems

Any bus that meets the TfL Bus Vehicle Specification.

Slip resistance testing should be carried out on all bus flooring materials in an as-new condition and various usage/age conditions. The Slip Prevention Assessment Protocol: Attachment 32, should be followed for the characterisation and acceptance of materials.

3 Training

Slip resistance testing should be carried out by a United Kingdom Accreditation Service (UKAS) accredited operator. Training may be provided by UKAS or another suitable training body if required.

Training for flooring installation should be provided by the flooring supplier.

4 Certification of flooring materials

Flooring material types¹ fitted to buses shall be supplied with a certification documentation pack that the slip resistance performance required by the 'London Bus Technical Specification' is met. The performance required is:

- At installation i.e. "as new", the material will be deemed a failure if the mean Pendulum Test Value (PTV) is found to be less than 36.0.

¹ For the purposes of this document a flooring material type is considered as materials that share the same trade name and are constructed from using the same component parts and manufacturing processes.



- After 100,000 persons have accessed the material, or after 6 months in service, whichever is sooner, the material will be deemed a failure if the mean PTV is found to be less than 36.0
- Flooring material shall be assessed annually for a period of 7 years from the point of entering service. Throughout this period the material shall provide a minimum slip resistance. The material will be deemed a failure if the mean Pendulum Test Value (PTV) is found to be less than 40.0.

Assessment of the skid resistance of the materials must be carried out in accordance with the assessment protocol defined in Attachment 32. The assessment of materials must be carried by persons accredited by UKAS for the operation of the Portable Skid Resistance Tester (PSRT). This includes individuals working for the material manufacturer, bus manufacturer, bus operator or third party test house.

The certification of materials should, where appropriate take into account possible variations in material performance between manufactured batches. This may require the assessment of material samples installed in a number of different vehicles.

For a material to be certified for use, documentary evidence of the performance of flooring material types should be submitted in the form of UKAS certificates which present as a minimum:

- The material type being assessed
- The vehicle details on which the assessed material was installed
- The Mean PTV of the material in each test direction
- An approximation of the number of passengers transported by the vehicle at the assessment stage
- The amount of time that the flooring material type was in service for at the assessment stage

This certification documentation pack should be based on one of the following options depending on whether the material is an existing or new material:

- Performance measured on in-service buses, for 'existing' materials
- Performance measured on in-service buses, for 'new' materials
- Performance measured in the laboratory, for 'existing' materials
- Performance measured in the laboratory, for 'new' materials

Each of these options is described in more detail below.

Ideally the assessment of materials will be carried out on in-service vehicles. However, to encourage innovation, laboratory tests may be deemed acceptable.

4.1 Performance measured on buses

Materials may be certified by assessing their performance on current, in-service buses.

Materials shall be assessed at each of the requisite age/usage intervals as stated in section 4. Evidence for each of the assessment increments may be gathered quickly by using materials at various ages across multiple, in-service, vehicles.

New materials may be certified by assessing the performance of those materials on in-service buses. New flooring shall have been installed by appropriately trained individuals, as per section 3. Materials shall be assessed and reported at each of the



requisite age/usage intervals stated in section 4. Should the material fail to achieve the criteria required at any stage then it must be replaced.

For certification to be achieved the performance of the materials should be assessed following the procedure defined in Attached 32 and meet the requirements specified in the London Bus Service Limited New Bus Specification Section 4.5.6.

4.2 Performance measured in the laboratory

Materials may be certificated by measuring the performance of representative samples within a laboratory.

Materials shall be assessed at each of the requisite age/usage stated in section 4.

Accelerated wear for a material coupon may be used to simulate the footfall experienced by the flooring materials at the required intervals. Additional evidence showing a strong correlation must be presented between the mean PTV for a coupon with accelerated wear against the equivalent in-service wear.

For certification to be achieved the performance of the materials should be assessed following the procedure defined in Attached 32 and meet the requirements specified in the London Bus Service Limited New Bus Specification Section 4.5.6.

5 Replacement or repair of flooring materials

5.1 Inspection

The bus flooring material shall be inspected using the standard intervals and protocols specific to the bus operating company. It is recommended however that inspections are carried out every 5 - 7 years'. The flooring material shall be visually inspected for any obvious defects following the standard inspection regimes used by the bus operating company and areas containing defects (as defined by the operating companies inspection regime) noted.

5.2 Replacement

If defects are identified the affected section of the surface should be completely replaced with one characterised as providing a low slip potential. A section of the surface is defined as an area of the surface which can be independently defined by its use. For example, a bus may consist of the following surfacing sections:

- Entrance ways
- Aisles
- Stairwells and landings
- Disabled reservation areas
- Etc.

If therefore a defect was identified in the aisle of a bus, then the entire width of flooring between the seats should be replaced.

Persons replacing bus flooring materials should be trained and competent to do so. The manufacturer's installation instructions should be followed precisely when replacing materials and, if available, training by the material manufacturer should be



given. Particular care should be taken when welding material joints in order to protect the underlying materials.

5.3 Inspection and repair of the underlying materials

After the removal of defective material (and the surrounding area), the underlying materials should be inspected for damage and repaired as necessary. Conducting repairs at this stage will lengthen the life of the flooring materials and the bus.

6 Cleaning of bus flooring materials

The selection of bus flooring materials should take into account their cleaning and maintenance procedures. It is advised that materials with high levels of texture, or materials that are very coarse are not used. These materials are likely to provide high levels of PTV but will also be very hard to clean and could trap dirt and contaminants that could ultimately reduce their PTV characteristics.

Bus flooring materials should be cleaned regularly following the manufacturers recommended procedures. In cases where there are no manufacturer recommended procedures the following should be carried out:

1. Daily:
 - a. Vacuum the surface to remove dust and debris,
 - b. Use a mop to clean floor with clean water and a 2-5% neutral detergent solute as per manufacturer's instructions,
 - c. Rinse surface with a thoroughly cleaned mop and clean water to remove detergent residue.
 - d. Vacuum dry.
2. Once per month or after heavy soilage:
 - a. Vacuum the surface to remove dust and debris,
 - b. Scrub grease or oil spots only with a medium stiff bristled hand brush, rotocleaner or dingle brush machine with alkaline detergent
 - c. Use a mop to clean floor with clean water and a 2-5% neutral detergent solute as per manufacturer's instructions,
 - d. Rinse surface with copious amounts of clean water using a thoroughly cleaned mop to remove detergent residue.
 - e. Vacuum dry.
3. Never:
 - a. Use an electric scrubber with abrasive discs,
 - b. Use solvents,
 - c. Use industrial stain removers without first testing on a discrete area out of natural corridors,
 - d. Leave detergent residue on the floor,
 - e. Apply any surface treatment,
 - f. Use high pressure devices,
 - g. Place any form of rubber on the flooring.



7 Considerations of flooring colouring and patterns

It should be noted that the use of darker colours for bus floorings is preferential to lighter colours as dirt and detritus is less contrasting with darker colours and so is less visible.

There is a potential that flooring which is reflective or has reflective elements can look “sparkly” or “shiny”. There is the potential for some bus passengers to sub-consciously associate these features with flooring that is wet and therefore slippery. In these cases it is likely that these users will adjust their gait to compensate for the perceived lack of slip resistance. This is undesirable as it increases the risk to the passenger who may become off balanced or even fall as a result. With this in mind the use of materials with a matt hue are preferred to those with satin or gloss hues.



Attachment 34: Occupant Friendly Interiors Assessment Protocol

1 Introduction

This document presents a protocol for inspection of a bus interior to identify potential injury hazards and the assessment and rating of hazards identified.

The categories of potential hazards include Handrails, Restraints, Partitions, inadequately constrained seated passengers, and General/other hazards such as sharp corners and protrusions.

For full understanding of this Attachment it should be read in conjunction with the Attachment 35: Occupant Friendly Interiors Guidance Notes and New Bus Specification, Section 4.5.5.

2 Scope

This protocol applies to all new buses intended for service under contract to TfL that are passenger vehicles with a maximum mass exceeding 5 tonnes and a capacity exceeding 22 passengers. The passenger vehicles will be capable of carrying seated but unrestrained occupants and standing occupants. Such vehicles are categorised in the Consolidated Resolution on the Construction of Vehicles (R.E.3) as M₃; Class I, Class II.

3 Purpose

The purpose of this assessment is to identify potential injury hazards present in the vehicle design. The protocol assesses and rates the identified hazards with the objective of encouraging safer vehicle designs, with minimal constraints for the vehicle designers. The protocol has been written to enable assessment using drawings or CAD models of the vehicle at the design stage.

4 Normative references

The following normative documents, in whole or in part, are referenced in this document and are indispensable for its correct application. For dated references, only the edition cited applies. For undated references, the latest edition of the referenced document (including any amendments) applies.

- London Bus Services Limited New Bus Specification: Section 4.5.5
- London Bus Services Limited New Bus Specification: Attachment 35 Occupant Friendly Interiors Guidance Notes

5 Definitions

For the purpose of this Protocol:

- **3D:** Three dimensional, components in the x, y and z axes.
- **Approval Authority:** The Approval Authority is the body within TfL that certifies that a bus is approved for use in the TfL fleet and assigns its score under the bus safety standard for use in procurement processes.
- **Computer-Aided Design (CAD):** The use of computer systems to aid in the creation, modification, analysis, or optimization of a design.
- **Floor:** Vehicle floor where a passenger's feet will rest when seated or standing.
- **Head impact zone:** Height range in which a standing or seated passenger's is usually positioned. Heights are defined for specific occupants in the relevant sections of this protocol.
- **'High occupancy / PRM' seats:** Seats with high occupancy rate and / or used by Persons with Reduced Mobility (PRM)—These seats include nominated priority / preferential seats, all seats on the main floor level and any seats immediately adjacent to a door. "Immediately adjacent to a door" means any seat in a row of seats near a door, even if only accessible via a step. Example of these seats behind the middle doors and wheelchair area with step to access are shown in Figure 34_1.



Figure 34_1: Examples of seats with high occupancy rate immediately adjacent to a door and only accessible via a step.

- **Partition-like structure:** Note that a partition like structure is defined as a continuous structure with apertures no greater than 50 mm and a lower edge not more than 100 mm above the floor where the passenger's feet rest.
- **Passenger trajectory plane (PTP):** Vertical planes which describe the likely directions of travel for a passenger who is thrown forward in the vehicle.



- **Position line (PL):** Lines which represent a position from which a passenger could be thrown forward in the vehicle
- **Primary handrail:** The handrail being assessed
- **Secondary handrail:** A handrail that can be used by a passenger to prevent a collision with the primary handrail.
- **Test Service:** The organisation undertaking the testing and certifying the results to the Approval Authority
- **OEM: Original Equipment Manufacturer** – The company responsible for the manufacture of a completed bus, delivered to a bus operator
- **Vehicle under Test (VUT):** Means the vehicle assessed according to this protocol.

6 Test conditions

This protocol has been developed to be applied during the design of buses. This protocol shall be applied to CAD models or drawings of the VUT.

7 Test preparation

The following assessment envelopes/zones shall be defined by the Test Service in a universally compatible 3D CAD format e.g. *.IGES or *.STEP.

7.1 Standing passenger vertical handrail assessment space envelope.

A plan view of the envelope is shown in Figure 34_2.

Each of the boxes shall be 500mm x 500mm area

The envelope shall extend from the ground plane of the VUT to a height of 1870mm. The ground plane of the space envelope shall follow the profile of the vehicle floor, this should include any steps that are present. It is possible that the additional height of the steps may increase the height of the head for an occupant standing in boxes affected by step height, this would render these boxes out of scope for further assessment.

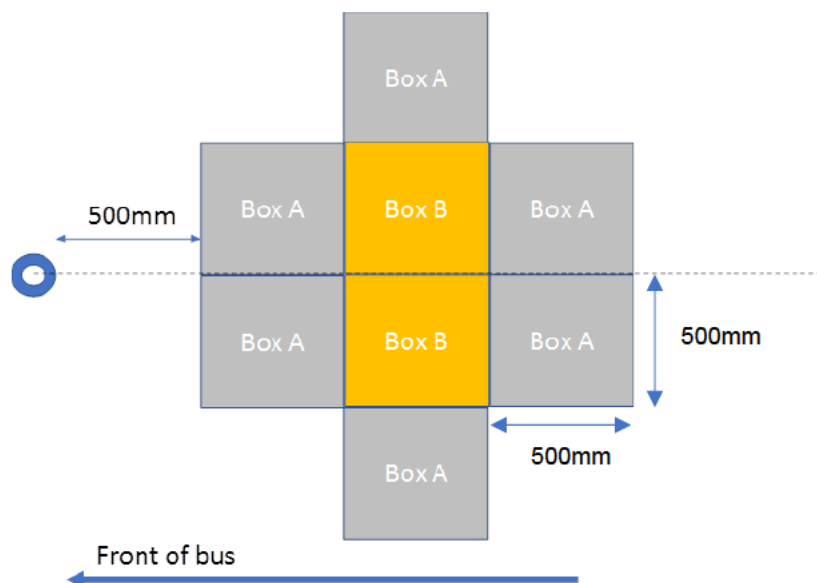

Figure 34_2: Plan view of the vertical handrail assessment space envelope.

Seated passenger handrail assessment zone. A side view of this zone relative to the seat being assessed is shown in Figure . The zone shall extend for the width of the seat being assessed.

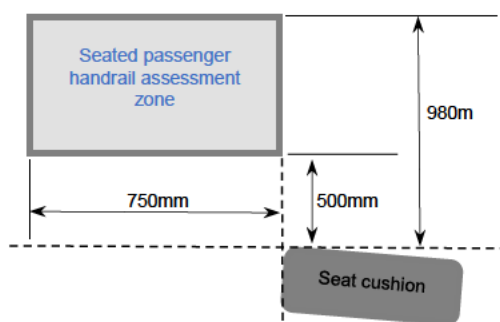

Figure 34_3: Side view of seated passenger handrail assessment zone

8 Test procedure

8.1 Standing passengers

This test only applies to the lower deck of the VUT on the basis that standing (for substantial periods) is prohibited on the upper deck.

8.1.1 Handrails

This procedure considers vertical and horizontal handrails separately.



8.1.1.1 Vertical handrails

A vertical handrail is a vertical structure which passes through two horizontal planes; 1310 mm and 1870 mm above the floor of the VUT at the location where the structure is installed. The diameter or width of the vertical structure in the vehicle's lateral plane shall be less than 45 mm. Attachments to the hand rails such as Oyster Card readers shall not be included in the definition of the structures diameter/width. All vertical handrails shall be identified.

Apply the Vertical Handrail Assessment Space Envelope to each of the vertical handrails identified. The centre of the handrail being assessed is the reference point for the template.

Identify the boxes in which a passenger is likely to stand by applying the following criteria:

Identify encroaching structures for each of the boxes within the space envelope.

There shall be at least space to fit a circle of 250 mm diameter touching the edge of the box that does not have any permanent structure encroaching within it for the box to be assessed that a passenger is likely to stand in it.

Determine if a passenger has an unobstructed path from a box to fall against the primary handrail. There shall be an unobstructed corridor at least 250 mm wide from the box to the primary handrail, defined using the following method:

- a) Along the forward edge of the box, draw three position lines (PL) each 250 mm long, one from each of two box corners to the edge's centre point, and one with the edge's centre point at its mid-point (see Figure top picture lines in black, blue and red).
- b) For each PL, draw potential trajectory corridors by extending a vertical plane from each end of the position line to the edge of the handrail (so that the edge of the handrail is just touching the boundary of each corridor). The plane extending from the end of the PL farthest away from the primary handrail shall contact the handrail at the farthest point and the plane extending from the end of the PL nearest the handrail shall contact the handrail at its nearest point. Add two other planes parallel to each of these lines as illustrated in Figure bottom picture. When complete this will give 6 corridors; two corridors for each PL.

If one or more of these corridors does not have a structure encroaching into it (at a height less than 1870 mm above bus floor level), it is deemed that a passenger has an unobstructed path to the primary handrail. Note that structures less than 300 mm from the primary handrail which do not shield it completely in the head impact zone (1420 mm to 1755 mm above bus floor) should not be counted as obstructions.

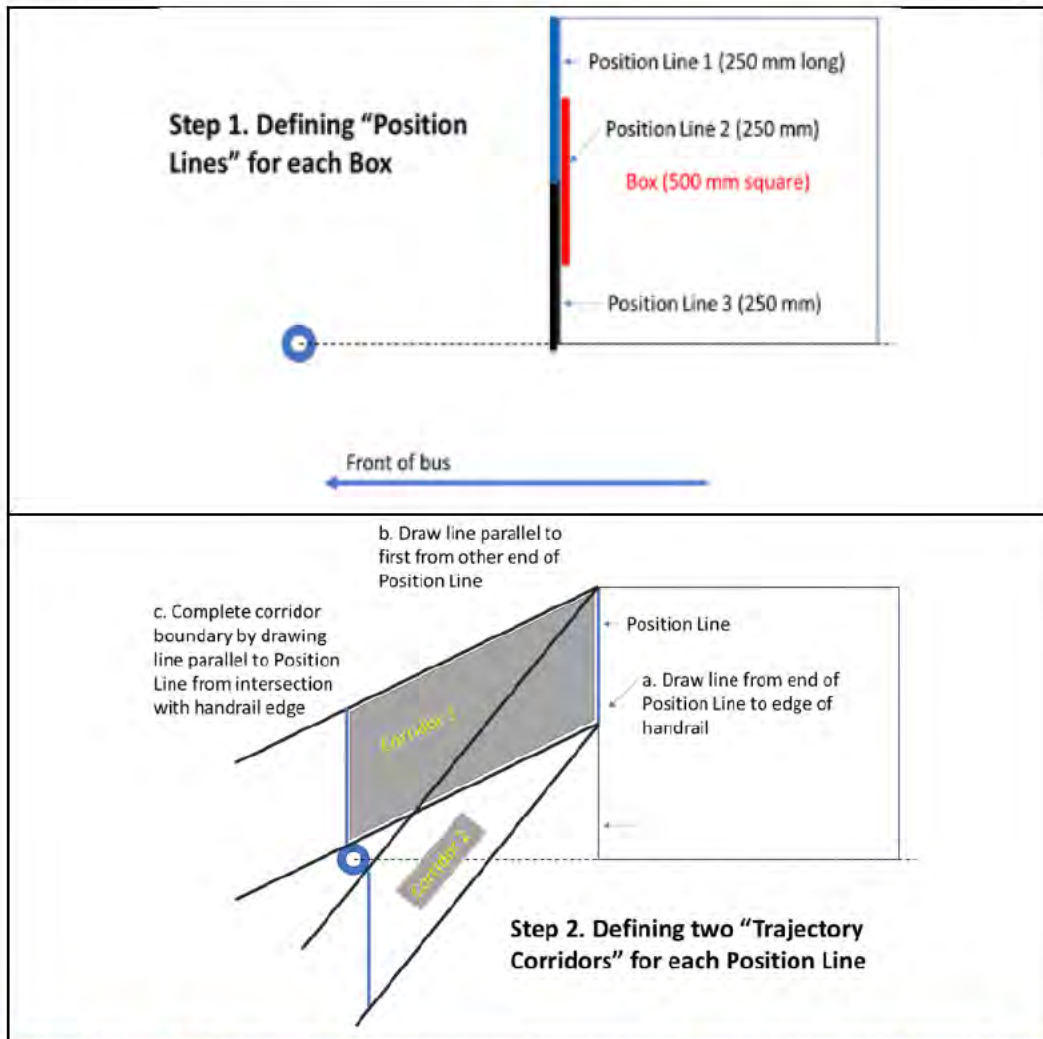

Figure 34_4: Procedure to assess presence of unobstructed corridor to vertical handrail.

Determine whether passengers have an opportunity to grab another handrail (secondary handrail) to prevent a collision with the primary handrail using the following method:

- a) The Passenger Trajectory Plane (shall be drawn from the centre of the front of each box to the centre of the primary handrail.
- b) A secondary handrail is defined as one positioned at least 500 mm longitudinally from the primary handrail and within a corridor extending 250 mm either side of the PTP. In the case of curved handrails, the above measurements shall be taken at a height of [1384]mm from the floor height.

Figure shows an example of a seat back handrail (secondary handrail) positioned to give an opportunity to a passenger standing in the indicated boxes to prevent a collision with the primary handrail.

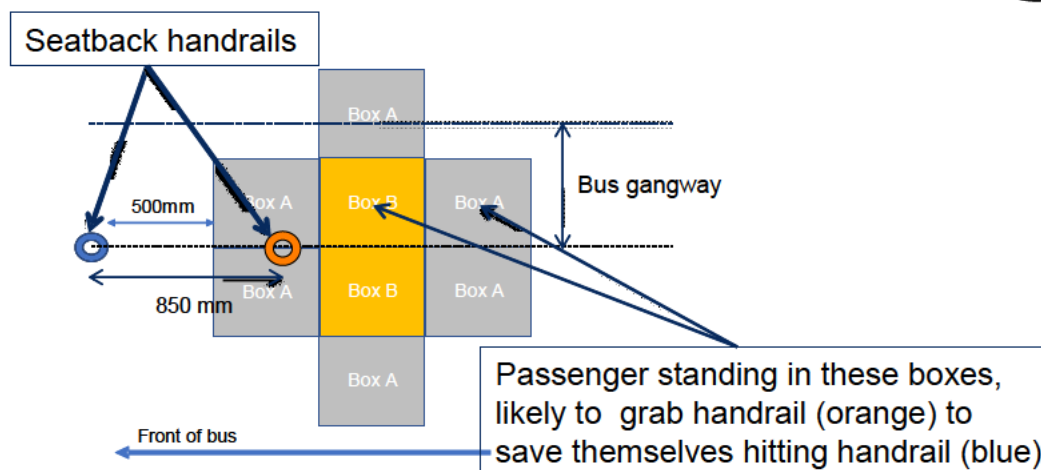

Figure 34_5: Example of a seat back handrail positioned to give standing passenger opportunity to prevent a collision with the primary handrail.

8.1.1.2 Horizontal handrails

All horizontal handrails shall be identified.

The height of the middle of each handrail above the bus floor shall be measured. The length of each handrail shall also be measured.

8.1.2 Restraint

Partitions that a passenger can stand behind shall be identified. These are defined as partitions which have a space extending at least 500 mm rearward across the width of the partition and to a height of 1870 mm.

The width of the partitions identified shall be measured.

For partitions with a width greater than 500 mm, the height of the partition above the VuT floor shall be measured:

Where the partition consists of more than one structure, the height of the highest structure shall be measured, e.g. the height of the seat backs for the partition illustrated in Figure .

Where the height of the partition above the floor varies, an average height shall be measured.



Figure 34_6: Example of partition consisting of multiple structures

8.1.3 General/other hazards

General hazards meeting the following criteria shall be identified:

- a) Within the head impact zone – features with a shore hardness¹ rating greater than 60 with a radius less than 20mm. In certain circumstances, it may be difficult to identify if contact with a specific edge or hazard is possible. If clarification is required a 165mm diameter spherical headform should be used and if contact cannot be made then the hazard shall be ignored.
- b) Outside the head impact zone – features with a shore hardness rating greater than 60 with a radius less than 5mm.

Examples include step corners, armrests, corners of Passenger Information Systems (PIS) and ceiling mounted mirrors which are mounted within the head impact zone (Figure). Note: the intent of this clause is to ensure only those hazards that can be contacted need to meet the radii requirements.

Items that move when impacted such as grab handles on straps attached to structures above 1870mm from the VUT floor shall not be identified as a hazard.

¹ Shore hardness is defined as a material's resistance to indentation when a static load is applied.



Figure 34_7: Examples of general hazards for standing passengers, corner of step (left) and mirror in head impact zone (right).

8.2 Seated passengers

The assessment shall be completed for both the lower and upper decks for forward facing seats.

8.2.1 Handrails

Identify handrails positioned within the seated passenger handrail assessment zone. Examples of handrails in this zone are shown in Figure . Handrails can be vertical or horizontal.

For each of the handrails identified, take the following measurements relative to the longitudinal centreline of the seat:

D_{LatHR} - Lateral (y-axis) distance from boundary (edge) of the handrail nearest to the seat centreline to the outer edge of the seat.

W_{seat} - The maximum width of the seat.

Identify whether or the handrails assessed are associated with 'high occupancy / PRM' seats.



Figure 34_8: Examples of handrails positioned behind middle doors in trajectory of seated occupant that shall be identified for further assessment.

8.2.2 Restraint

For each seat, identify the level of restraint present using the following categories:

- a) No partition-like structure or other seats in front
- b) Bay seat arrangement
- c) Some structure within a longitudinal distance of 1200 mm from seat back

Where a seat has some structure in front of it, take the following measurements:

H_{feet} - The average height above the floor on which the passenger's feet rest for the seating position being assessed.

W_{seat} - The maximum width of the seat.

W_{eff} - The effective seat width, 75% of the maximum width positioned around the seat centreline.

D_{LatRes} - Lateral (y-axis) not covered by restraint structure. Measure the distance from the boundary (edge) of the nearest restraint structure to the effective seat width.

Identify whether or not the restraints assessed are associated with PRM seats.

Inadequate restraint of passengers on some seats

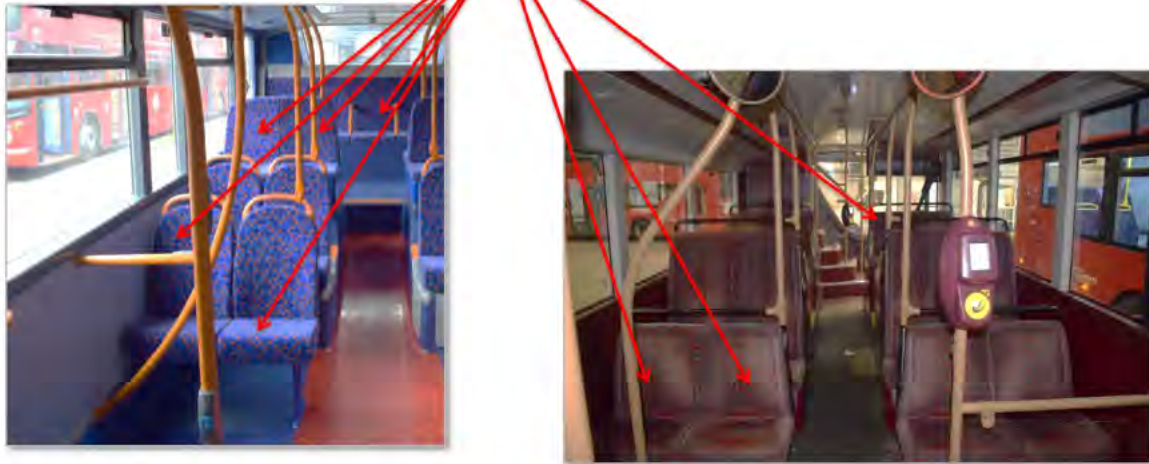

Figure 34_9: Examples of seats where there is inadequate restraint of seated passengers.

8.2.3 General hazards

Hazards meeting the following criteria shall be identified:

- a) Within the head impact zone – features with a shore hardness² rating greater than 60 with a radius less than 20mm.
- b) Outside the head impact zone – features with a shore hardness rating greater than 60 with a radius less than 5mm.

Examples include bolt heads, corners of Passenger Information Systems (PIS) and luggage racks which are mounted within the head impact zone (Figure). Note: a full height, flat glass partition in front of seated passenger is also considered a hazard. This is because it is highly likely to cause a head injury to a passenger if impacted and the risk of an impact is high.

² Shore hardness is *defined* as a material's resistance to indentation when a static load is applied.



Protruding bolt heads in lower body impact area:

Injury potential – low

Risk of impact - low



Sharp corner on PIS in head impact area:

Injury potential – high

Risk of impact - low



Luggage rack rail behind rear facing seats in head impact zone:

Injury potential – high

Risk of impact - high



Full height glass partition in front of forward facing seats covering head impact zone:

Injury potential – high

Risk of impact - high

Figure 34_10: Examples of general hazards for seated passengers



9 Assessment of results

9.1 Standing passengers

9.1.1 Handrails

9.1.1.1 Vertical

The boxes in the assessment template are scored as follows:

- a) A score of 0.1 is given for each Box A that a passenger could stand in and which:
 - i. Has an unobstructed path to the handrail; and
 - ii. Presents no opportunity for the passenger to grab a secondary handrail.
- b) If any of these criteria are not met, the box is scored 0.
- c) A score of 0.2 is given for each Box B that a passenger could stand in and which:
 - i. Has an unobstructed path to the handrail; and
 - ii. Presents no opportunity for the passenger to grab a secondary handrail.
- d) If any of these criteria are not met, the box is scored 0.

This results in maximum score of 1 for a handrail.

In the following situations this score is factored:

- a) In the case that a handrail does not have a length of 560 mm between the lower boundary of 1310 mm and upper boundary of 1870 mm, e.g. it is not vertical. In this case the length of the handrail projected into the Y plane (i.e. plane transverse across the bus) should be measured and a factor of (handrail length)/560 applied.
- b) In the case of handrails that curve away behind an obstruction (e.g. going further behind a row of seats), only those parts of the handrail within 250 mm of a longitudinal of the obstructing structure's outermost edge shall be considered within the zone. The length of handrail within the zone shall be measured and a factor of (handrail length)/560 applied.

9.1.1.2 Horizontal

Using the data collected, each handrail shall be assessed as follows:

- a) For handrail height below 1130 mm score 0.
- b) For handrail height greater than 1130 mm and less than 1420 mm, linearly score between 0 and 1 by application of formula below:
- c) $\text{Score} = (\text{'handrail height (mm)'} - 1130 \text{ mm}) / (1420 \text{ mm} - 1130 \text{ mm})$
- d) For handrail height greater than 1420 mm and less than 1755 mm, score 1
- e) For handrail height greater than 1755 mm and less than 1870 mm, linearly score between 1 and 0 by application of formula below:
- f) $\text{Score} = (1870 \text{ mm} - \text{'handrail height (mm)'}) / (1870 \text{ mm} - 1755 \text{ mm})$
- g) For handrail height above 1870 mm score 0.

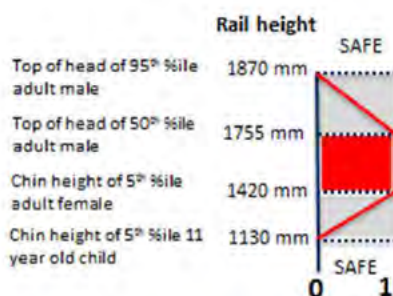

Figure 34_11: Illustration of assessment for horizontal handrail based on its height above the bus floor.

The score for each handrail shall be factored per 500 mm length by application of the formula below:

$$\text{Score} = (\text{'handrail score'}) \times (\text{handrail length mm}) / 500 \text{ mm}$$

9.1.2 Restraint

The partition is scored based on its height and width as below:

- 'Partition height' less than 770 mm score 1
- 'Partition height' greater than 770 mm and less than 1060 mm apply formula below:

$$\text{Score} = (1060 \text{ mm} - \text{'Partition height (mm)}) / 290 \text{ mm} \times (\text{'Partition length (mm)}) / 500 \text{ mm}$$

- Partition height greater than 1060 mm score 0



Figure 34_12: Illustration of assessment of restraint (partitions) for standing passengers.

The score for each partition shall be factored per 500 mm length by application of the formula below:

$$\text{Score} = (\text{'Partition score'}) \times (\text{partition length mm}) / 500 \text{ mm}$$

9.1.3 General/other hazards

A score of 1 shall be given to any such hazard identified, or group of such hazards if they fall within the area of a 100 mm sided square area.

9.1.4 Weighting of hazards for standing passengers

The following weightings shall be applied to the scores for standing passengers:

- a) Handrails – multiply by 5
- b) Restraint – multiply by 4
- c) General / other hazards – multiply by 3

9.2 Seated passengers

9.2.1 Handrails

The handrail shall be scored as illustrated in Figure as follows:

- a) If distance D_{LatHR} from the edge of the rail closest to the seat centre to the outer edge of the seat in the vehicles y-axis is less than 100 mm, handrail scores 0
- b) If distance D_{LatHR} from the edge of the rail closest to the seat centre to the outer edge of the seat in the vehicles y-axis is greater than half the seat width minus 90mm ($(W_{\text{seat}}/2) - 90 \text{ mm}$), handrail scores 1
- c) For distances in between those defined above, use the formula below to calculate a score between 0 and 1:

$$\text{Score} = (D_{\text{LatHR}} - 100 \text{ mm}) / (W_{\text{seat}}/2 - 190 \text{ mm})$$

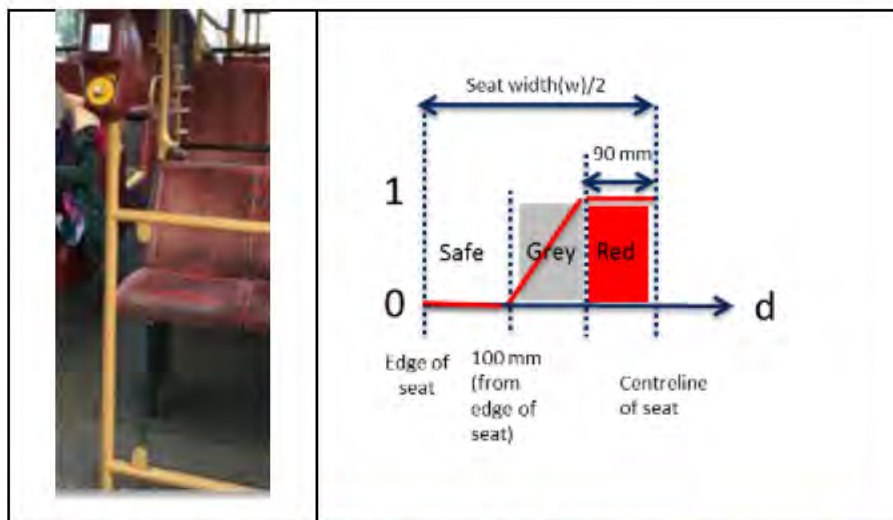

Figure 34_13: Procedure for assessment for handrails identified as a potential hazard for seated occupants

9.2.2 Restraint

The seats identified shall be assessed as follows:

- a) Seats with no or little structure in front of them (i.e. no partition like structure or other seats) shall be scored 1
- b) Bay seat arrangements shall be scored 0.75
- c) Seats with some structure (partition line structure or other seats) in front of them shall be assessed as follows:

The proportion of the effective seat width projected forward not covered by the restraint structure shall be calculated using the formula below (see Figure 34_15)

- i. Proportion not covered (P_{we}) = 'distance not covered in mm' (D_{LatRes}) / 'Effective seat width mm' (W_{eff})
- ii. If the height of the structure is 800 mm or greater, score ($1 * P_{we}$)
- iii. If the height of the structure is 700 mm or less, the structure's height is in red zone, score 1.
- iv. If height of structure is between 700 mm and 800 mm, the formula below shall be applied to calculate score between 0 and 1:

$$\text{Score} = (P_{we}) + (800\text{mm} - \text{Structure's height mm})/100\text{mm}$$

Note: Scores calculated to be greater than 1 should be capped at 1.

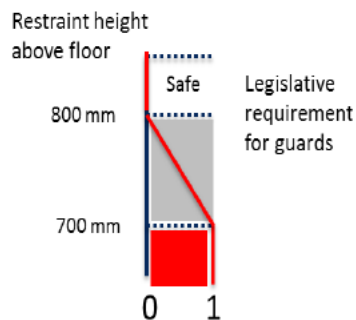

Figure 34_14: Illustration of safe, grey and red zones for height of restraint assessment

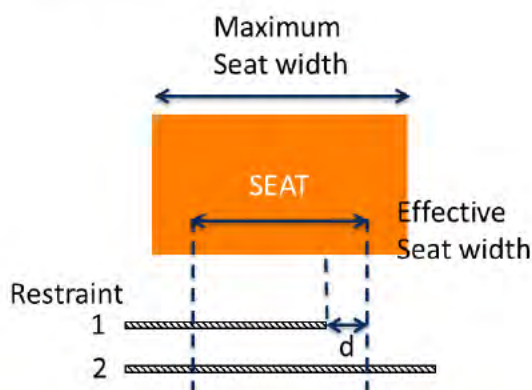

Figure 34_15: Illustration of effective seat width not covered by restraint structure, distance, d , for Restraint No 1, all covered by Restraint No 2, i.e. $d = 0$

9.2.3 General/other hazards

For each seat position, an assessment of the injury potential and risk of impact shall be made for the hazards identified and a score of up to 1.0 given, in accordance with the following criteria:

- a) Injury potential:
 - i. For head impact categorise as high
 - ii. For impact of other body regions categorise as low
- b) Risk of impact:
 - i. For small sized hazard such as single bolt head (or single group of hazards within 100 mm of each other) categorise as low
 - ii. For hazard covering area likely to be impacted by body region e.g. multiple small sized hazards (e.g. > 4) or single hazard covering area in good alignment with head trajectory categorise as high
- c) Score:
 - i. Injury potential low, risk of impact low; score 0.3
 - ii. Injury potential high, risk of impact low and vice versa; score 0.6
 - iii. Injury potential high, risk of impact high; score 1.0

9.2.4 Weighting of hazards for seated passengers

The following weightings shall be applied to hazards not associated with 'high occupancy / PRM' seats:

- a) Handrails – multiply by 5
- b) Restraint – multiply by 4
- c) General / other hazards – multiply by 4

For 'High occupancy / PRM' seats, the following weighting shall be applied:

- a) Handrails – multiply by 10



- b) Restraint – multiply by 8
- c) General / other hazards – multiply by 8

10 Assessment template

Each of the scores shall be entered into an assessment template made up of the tables shown in Appendix A - Assessment Template.

The Total Actual Score is the sum of the weighted score for each assessment section, which are highlighted yellow. A separate value shall be calculated for the lower saloon, the upper saloon and the vehicle as a whole.

11 Normalising the score

The basic score system above produces a higher score the greater the number of hazards identified and, theoretically, there is no upper limit to the score. Ideally the score would be zero with no identified hazards.

In order to incorporate the interiors score within an overall bus safety score, it is necessary to 'normalise' this score to a value between 0% and 100%, where 0% represents the worst vehicles and 100% the best.

In order to do this a maximum points ceiling shall be set at 120 points for the lower saloon and 12 points for the upper saloon. Thus the overall maximum score is 120 points for a single deck vehicle and 132 points for a double deck vehicle.

A Total Limited Score shall be defined for the lower saloon, the upper saloon and the vehicle as a whole and shall be the lesser of the Total Actual Score and the Maximum score.

The Normalised Score for lower saloon, upper saloon and whole vehicle shall be calculated according to the formula $1 - (\text{Total Limited Score} / \text{Maximum Score})$ and expressed as a percentage.

12 Test report

The Test Service shall provide a comprehensive test report that will be made available to the Approval Authority. The test report shall consist of the following distinct sections:

- a) Confirmation of protocol compliance
- b) Reference information.

To confirm protocol compliance, the Test Service shall include in the report the completed Occupant Friendly Interiors Assessment worksheet

The reference information required includes as a minimum:

- a) Vehicle make;
- b) Vehicle model;
- c) Vehicle model variant;
- d) Details of the Test Service; and



e) Test date(s).



Appendix A - Assessment Template

Note: Values entered in the tables below are fictional values for illustrative purposes only.

Section 1. Standing Passengers										Weighted	
Vertical (& near) Handrails	Length factor	Box A's (Max 0.1 each)						Box B's (Max 0.2 each)		Total	15.04
		Score	Score	Score	Score	Score	Score	Score	Score		
Handrail 1	1.00	0.10	0.10					0.20		0.40	
Handrail 2	1.00	0.10								0.10	
Handrail 3	1.16	0.10	0.10	0.10				0.20		0.58	
Handrail 4	0.00									0.00	
Handrail 5	1.00	0.10	0.10	0.09	0.09			0.20	0.20	0.78	
Handrail 6	0.86	0.10	0.10					0.20		0.34	
Handrail 7	0.86	0.10	0.10					0.20		0.34	
Handrail 8	0.86	0.10	0.10					0.20		0.34	
Handrail 9	0.71	0.10								0.07	
Handrail 10	0.45	0.10								0.05	
Handrail 11										0.00	
Handrail 12										0.00	
Handrail 13										0.00	
Handrail 14										0.00	
Handrail 15										0.00	
Handrail 16										0.00	
Handrail 17										0.00	
Handrails 18 or more										0.00	
For handrail curved in bus Y plane: Length Factor = (Length in mm between 1310 mm and 1870 mm from floor)/560; For straight handrails Length Factor = 1 0 For handrail that curves behind obstruction: Length Factor = (Length in mm between 1310 mm and 1870 mm from floor AND < 250 mm from edge of obstruction)/560											
Horizontal (& near) Handrails	Length Factor	Red/Grey/Safe Zone factor								Total	13.00
Handrail 1	2.60	1.00								2.60	
Handrail 2										0.00	
Handrail 3										0.00	
Handrail 4										0.00	
Handrail 5										0.00	
Handrail 6 or more										0.00	
Length Factor = (Length in mm)/500 Red Zone Factor (F rail > 1420 mm from floor AND rail < 1755 mm) = 1 Grey Zone Factor (if rail between 1755 mm and 1870 mm from floor) = (1870 - 'height of rail from floor in mm') /115 Grey Zone Factor (if rail between 1130 mm and 1420 mm from floor) = ('height of rail from floor in mm' - 1130)/290 Safe Zone Factor (if rail > 1870 mm from floor OR < 1130 mm from floor) = 0											
Restraint	Length factor	Red/Grey/Safe Zone factor								Total	0.00
Restraint 1	0.00	1.00								0.00	
Restraint 2										0.00	
Restraint 3										0.00	
Restraint 4										0.00	
Restraint 5										0.00	
Restraint 6 or more										0.00	
Length Factor = (Length in mm)/500 Red Zone Factor (F partition height < 770 mm from floor) = 1 Grey Zone Factor (if partition height between 770 mm and 1060 mm from floor) = (1060 - 'partition height from floor in mm')/290 Safe Zone Factor (if partition height > 1060 mm from floor) = 0											
General/Other Hazards	Score (0 or 1)								Total	9.00	
Hazard 1	1.00								1.00		
Hazard 2	1.00								1.00		
Hazard 3	1.00								1.00		
Hazard 4									0.00		
Hazard 5									0.00		
Hazard 6									0.00		
Hazard 7									0.00		
Hazard 8									0.00		
Hazard 9									0.00		
Hazard 10 or more									0.00		
Section 2. Seated Passengers (Lower Deck)											
Handrails	ed/Grey/Safe Zone Fact	No. identical (seats)	PRM seat? (Y/N)							Total	40.71
Handrail 1	1.00	1.00	Y							2.00	
Handrail 2	0.86	2.00	Y							3.43	
Handrail 3	0.86	2.00	N							1.71	
Handrail 4	1.00	1.00	N							1.00	
Handrail 5										0.00	
Handrail 6										0.00	
Handrail 7										0.00	
Handrail 8										0.00	
Handrail 9										0.00	
Handrail 10										0.00	
Handrail 11										0.00	
Handrail 12 or more										0.00	
Red Zone Factor (F distance edge of rail nearest to seat centreline to outer edge of seat in mm (d) > ('half seat width in mm' (w/2) - 90) = 1 Safe Zone Factor (F distance edge of rail nearest to seat centreline to outer edge of seat in mm (d) < 100) = 0 Grey Zone Factor (F distance edge of rail nearest to seat centreline to outer edge of seat in mm (d) > 100 AND < ('half seat width in mm' (w/2) - 90) = (d - 100)/(w/2 - 190)											



Restraint Hazards	Red/Grey/Safe Zone Factor	Proportion not covered factor	PRM seat? (Y/N)	Total
Restraint 1	1.00	1.00	N	1.00
Restraint 2	0.75	1.00	N	1.00
Restraint 3	0.75	1.00	N	1.00
Restraint 4				0.00
Restraint 5				0.00
Restraint 6 or more				0.00

Score 1 if seat facing directly into aisle or other empty space. Score 0.75 for pair of front-facing bay seats
 Red zone factor (F height of restraint above floor in mm (h) < 700 mm) = 1
 Safe zone factor (F height of restraint above floor in mm (h) > 800 mm) = 0
 Grey zone factor (F height of restraint above floor in mm (h) > 700 mm and < 800 mm) = (800 - h)/100
 Proportion (of effective seat width) not covered factor (Pwe) = 'distance not covered in mm' (d) / 'Effective seat width mm' (we)
 For safe zone score add Pwe
 For grey zone score add Pwe and if score > 1, cap score of 1

General/Other Hazards	Score (0.3, 0.6 or 1)	No. identical (seats)	PRM seat? (Y/N)	Total
Hazard 1				0.00
Hazard 2				0.00
Hazard 3				0.00
Hazard 4				0.00
Hazard 5				0.00
Hazard 6				0.00
Hazard 7				0.00
Hazard 8 or more				0.00

Injury potential: Head impact high; Other body regions low
 Risk of impact:
 i. For small sized hazard such as single bolt head (or single group of hazards within 100 mm of each other) categorise as low;
 ii. For hazard covering area likely to be impacted by body region e.g. multiple small sized hazards (e.g. > 4) or single hazard covering area in good alignment with head trajectory categorise as high
 Score:
 i. Injury potential low, risk of impact low; score 0.3
 ii. Injury potential high, risk of impact low and vice versa; score 0.6
 iii. Injury potential high, risk of impact high; score 1.0

Section 3. Seated Passengers (Upper Deck)

Handrails	Red/Grey Zone Factor	No. identical (seats)	PRM seat? (Y/N)	Total
Handrail 1	1.00	8.00	N	8.00
Handrail 2	1.00	1.00	N	1.00
Handrail 3			N	0.00
Handrail 4			N	0.00
Handrail 5			N	0.00
Handrail 6			N	0.00
Handrail 7			N	0.00
Handrail 8			N	0.00
Handrail 9			N	0.00
Handrail 10			N	0.00
Handrail 11			N	0.00
Handrail 12 or more			N	0.00

Red Zone Factor (F distance edge of rail nearest to seat centreline to outer edge of seat in mm (d) > ('half seat width in mm' (w/2) - 90) = 1
 Safe Zone Factor (F distance edge of rail nearest to seat centreline to outer edge of seat in mm (d) < 100) = 0
 Grey Zone Factor (F distance edge of rail nearest to seat centreline to outer edge of seat in mm (d) > 100 AND < ('half seat width in mm' (w/2) - 90) = (d - 100)/(w/2 - 190)

Restraint Hazards	Restraint height factor	Seat width factor	PRM seat? (Y/N)	Total
Restraint 1	1.00	1.00	N	1.00
Restraint 2			N	0.00
Restraint 3			N	0.00
Restraint 4			N	0.00
Restraint 5			N	0.00
Restraint 6 or more			N	0.00

Score 1 if seat facing directly into aisle or other empty space. Score 0.75 for pair of front-facing bay seats
 Red zone factor (F height of restraint above floor in mm (h) < 700 mm) = 1
 Safe zone factor (F height of restraint above floor in mm (h) > 800 mm) = 0
 Grey zone factor (F height of restraint above floor in mm (h) > 700 mm and < 800 mm) = (800 - h)/100
 Proportion (of effective seat width) not covered factor (Pwe) = 'distance not covered in mm' (d) / 'Effective seat width mm' (we)
 For safe zone score add Pwe
 For grey zone score add Pwe and if score > 1, cap score of 1

General/Other Hazards	Score (0.3, 0.6 or 1)	No. identical (seats)	PRM seat? (Y/N)	Total
Hazard 1			N	0.00
Hazard 2			N	0.00
Hazard 3			N	0.00
Hazard 4			N	0.00
Hazard 5			N	0.00
Hazard 6			N	0.00
Hazard 7			N	0.00
Hazard 8			N	0.00
Hazard 9			N	0.00
Hazard 10 or more			N	0.00

Injury potential: Head impact high; Other body regions low
 Risk of impact:
 i. For small sized hazard such as single bolt head (or single group of hazards within 100 mm of each other) categorise as low;
 ii. For hazard covering area likely to be impacted by body region e.g. multiple small sized hazards (e.g. > 4) or single hazard covering area in good alignment with head trajectory categorise as high
 Score:
 i. Injury potential low, risk of impact low; score 0.3
 ii. Injury potential high, risk of impact low and vice versa; score 0.6
 iii. Injury potential high, risk of impact high; score 1.0



Attachment 35: Occupant Friendly Interiors Guidance Notes

1 Introduction

This document sets out the guidance notes related to occupant friendly interiors and the bus interior safety assessment protocol, Attachment 34. These guidance notes are aimed at bus operators and manufacturers as a practical guide for implementation of the Bus Safety Standard.

These notes are for guidance only, and are not legally binding. In all circumstances, the guidance provided by a manufacturer of the bus or system shall take precedence, and these guidance notes are only for use in the absence of other information. These are not intended to be exhaustive, but to point the operators toward practical advice and questions to raise with manufacturers/suppliers.

Any modifications to the bus interior which have been either stipulated or conducted by the bus operator must be included in any assessment following the procedure defined in Attachment 35: Occupant Friendly Interiors Assessment Protocol, such that the assessment is completed on a bus in an “in service” condition.

2 Explanation of approach for assessment protocol

The bus interior safety assessment protocol involves the identification and assessment of bus interior potential hazards (i.e. features that have injury causing potential) present in three categories; handrail, restraint and general (for standing and seated passengers), as shown diagrammatically in Figure . The assessment gives points for each potential hazard identified. More points are given for hazards which have greater injury causing potential and greater exposure (e.g. hazards associated with seats that are likely to be used more often). The aim is to encourage manufacturers to have as few potential hazards as possible and therefore score the minimum number of points, i.e. a lower score correlates with a better assessment.

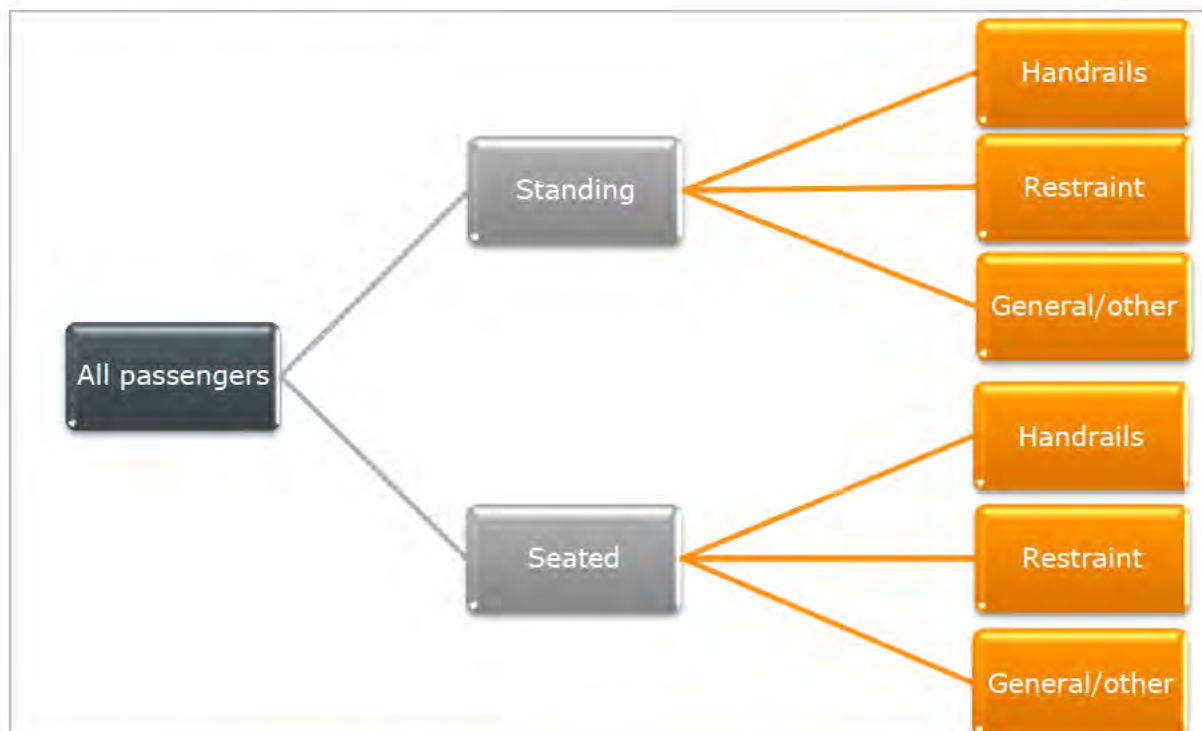

Figure 35_1: Visual inspection hazard categories

2.1 Summary method

The approach to perform an inspection and assessment is as follows:

- Identify and count potential hazards in each category for standing and seated passengers.
- Scale individual potential hazards according to passenger exposure. This step is also used to avoid discontinuities in the assessment system. To help understanding of this step, an example of the scaling for horizontal handrails, for standing passengers, is given in *Section 2.2*.
- Weight the score for each potential hazard identified in each of the six categories and sum them to give overall point scores for the lower deck and, if appropriate, the upper deck.

Weightings are applied to reflect the following:

- a) The injury potential of the hazard, e.g. if the hazard is likely to cause a head injury as opposed to a lower limb injury, a higher weighting is given.
- b) Exposure of the hazard, e.g. if the hazard is in an area of the bus with a higher occupancy rate, a higher weighting is given. Also, additional weighting is applied to hazards to which persons with reduced mobility (PRM) are likely to be exposed. This is because, generally, PRM have slower reaction times and are less tolerant to injury, which can increase their likelihood of impacting a hazard and being injured.

2.2 Example: Standing occupants - Horizontal handrails

Horizontal handrails can be positioned where they may be hit by a standing passenger's head, when that passenger falls. The likelihood of this occurring depends on the height of the rail. The more the rail is in alignment with a passenger's head, the more likely it is that it will be hit. To account for this and to avoid discontinuities, a sliding scale scoring system has been developed that gives a score ranging from 0 to 1. This results in red, grey and safe zones as illustrated in the left hand side of Figure below.

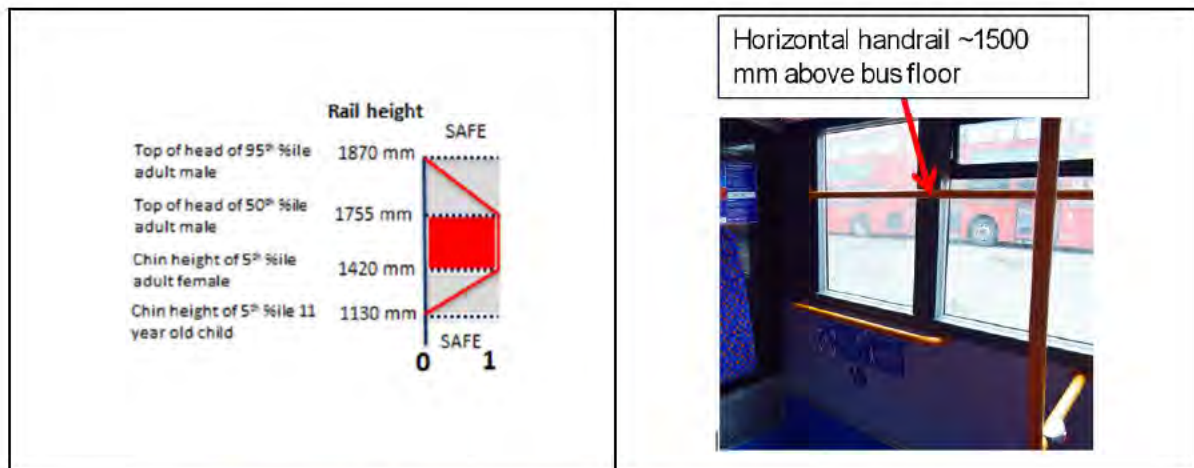

Figure 35_2: Illustration of Handrail safe zones

The red zone is positioned between 1420 mm (height of chin of 5th percentile female) and 1755 mm (height of top of head of 50th percentile male).. Therefore a passenger is likely to hit their head on a rail positioned at this height. Hence, a score of 1 (per unit length) is given for a horizontal rail positioned within this zone.

The grey zones are positioned above and below the red zone using a sliding scale as the proportion of the population reduces. Hence, a score linearly reducing from 1 to 0 per unit of length is given for a rail positioned in this zone depending on the precise height of its centre. For example a rail with a top edge height of 1800 mm would be scored $(1870 - 1800)/(1870 - 1755) = 0.61$ per unit length.

The bottom grey zone is positioned between 1420 mm (height of chin of 5th percentile female) and 1130 mm (height of chin of 5th percentile 11 year old child). A similar argument applies and approach is taken for this zone as for the top grey zone.

The safe zones are positioned above and below the grey zones. These zones are above 1870 mm (top safe zone) and below 1130 mm (bottom safe zone). The head height of a small proportion of the population will be in these zones. Therefore a score of zero is given for rails positioned in these zones.

The unit length chosen was 500 mm on the basis that this is approximately the space taken up by one passenger stood or leaning against the side of the bus.

Note: It can be seen that if a manufacturer decides to change the height of a horizontal handrail by a small amount, say 10 mm, then the score will only



change a small amount to reflect this, i.e. there are no discontinuities in the assessment system with the sliding scale approach.

3 Selection of buses/systems

A bus interior safety assessment should be carried out on each different bus model and variant in a 'ready for service' condition, i.e. with additional items such as TfL iBUS modules fitted. This assessment should be carried out by a TfL nominated supplier.

It is expected that manufacturers will wish to achieve given interior safety assessment values as targets for new bus designs. Therefore, they will need to be able to estimate the assessment values for potential designs throughout the design process. For these reasons, the assessment protocol has been kept as simple as possible (it is based mainly on simple measurements), so that it should be easily possible to perform an assessment based on 3D CAD information.

4 Training

Training and consultancy related to carrying out a bus interior assessment should be provided by a TfL nominated supplier.

5 Retro-fitment of additional items

Following the assessment of a bus model / variant in a 'service ready' condition by a TfL nominated supplier, additional items which alter the assessment should not be fitted to the bus (e.g. by operators). If it is necessary to fit items, which may alter the assessment, TfL should be consulted.



Attachment 36: Bus Impact Test Standard Assessment Protocol

1 Introduction

This document presents a procedure, hereon referred to as the Bus VRU Impact Test Standard (BITS), for objectively measuring the impact protection provided by the front end of a bus in the event of a collision with a vulnerable road user (VRU); in particular, when striking their head.

For full understanding of this Attachment it should be read in conjunction with the Attachment 37: Bus Impact Test Standard Guidance Notes and New Bus Specification, Section 4.6.3.

2 Scope

This protocol applies to all new buses intended for service under contract to TfL that are passenger vehicles with a maximum mass exceeding 5 tonnes and a capacity exceeding 22 passengers. The passenger vehicles will be capable of carrying seated but unrestrained occupants and standing occupants. Such vehicles are categorised the Consolidated Resolution on the Construction of Vehicles (R.E.3) as M₃; Class I, Class II.

3 Purpose

The purpose of this test and assessment protocol is to bring about an improvement in the construction of certain components of the front end of buses which have been identified as causing injury when in collision with a pedestrian's, or other vulnerable road user's, head.

The vehicles that will be tested under the Bus VRU Impact Test Standard (BITS) are representative of the majority of buses in circulation in the urban environment, where there is a significant potential for bus collisions with pedestrians and other vulnerable road users.

5 Normative References

The following normative documents, in whole or in part, are referenced in this document and are indispensable for its application. For dated references, only the edition cited applies. For undated references, the latest edition of the referenced document (including any amendments) applies.

- London Bus Service Limited New Bus Specification Section 4.6.3
- London Bus Service Limited New Bus Specification – Attachment 37: Bus Impact Test Standard Guidance Notes



- Directive 2007/46/EC of the European Parliament and of the Council establishing a framework for the approval of motor vehicles and their trailers, and of systems, components and separate technical units intended for such vehicles.
- International Standard ISO 384:1976. Road vehicles – Measurement of impact velocity in collision tests
- International Standard ISO 6487:2015. Road vehicles – Measurement techniques in impact tests – Instrumentation
- Regulation (EU) 2018/858 of the European Parliament and of the Council of 30th May 2018 on the approval and market surveillance of motor vehicles and their trailers, and of systems, components and separate technical units intended for such vehicles, amending Regulations (EC) No 715/2007 and (EC) No 595/2009 and repealing Directive 2007/46/EC.
- UN Regulation No. 107. Uniform provisions concerning the approval of category M₂ or M₃ vehicles with regard to their general construction.
- UN Regulation No. 127. Uniform provisions concerning the approval of motor vehicles with regard to their pedestrian safety performance.

6 Definitions

For the purpose of this protocol:

- **Adult headform** - is the test tool used to represent the head of an adult in these impact tests. It is identical to those used in UN Regulation No. 127 and GTR No. 9 and is defined specifically in Test impactor specifications.
- **Adult headform test area** - is an area on the outer surfaces of the front structure. The area is bounded:
 - a) At the lower edge, by a Wrap Around Distance (WAD) of [1,500]mm from the ground reference plane (with the vehicle at its nominal ride attitude) (WAD1500);
 - b) At the upper edge, by a WAD of [1,850] mm from the ground reference plane (with the vehicle at its minimum ride attitude) (WAD1850); and
 - c) At each side, by a line 82.5 mm inside the side reference line. The distance of 82.5 mm is to be set with a flexible tape held tautly parallel to the horizontal plane of the vehicle and along the outer surface of the vehicle.
- **A-pillar** - means the foremost and outermost roof support extending from the chassis to the roof of the vehicle.
- **Bus front end** - means all outer structures of the front end of the vehicle exposed to a potential collision with a VRU. It may therefore include, but is not limited to, the bumper, the bonnet or grille, scuttle, wiper spindles, lower windscreen frame, the windscreen, the windscreen header and the A-pillars.
- **Child headform** - is the test tool used to represent the head of a child in these impact tests. It is identical to those used in UN Regulation No. 127 and GTR No. 9 and is defined specifically in Test impactor specifications.



- **Child headform test area** - is an area on the outer surfaces of the front structure. The area is bounded:
 - a) At the lower edge, by a WAD of [1,115] mm from the ground reference plane (with the vehicle at its maximum ride attitude) (WAD1115);
 - b) At the upper edge, by a WAD [1,500] mm from the ground reference plane (with the vehicle at its nominal ride attitude) (WAD1500); and
 - c) At each side, by a line 82.5 mm inside the side reference line. The distance of 82.5 mm is to be set with a flexible tape held tautly parallel to the horizontal plane of the vehicle and along the outer surface of the vehicle.
- **Driver mass** - means the nominal mass of a driver that shall be [68] kg.
- **Ground reference plane** - means a horizontal plane, either real or imaginary, that passes through the lowest points of contact for all tyres of a vehicle. If the vehicle is resting on the ground, then the ground level and the ground reference plane are one and the same. If the vehicle is raised off the ground such as to allow extra clearance, then the ground reference plane is above ground level; and if the vehicle (perhaps a test sample) is lower than it would be in running order, then the ground reference plane is below the ground level.
- **Head Injury Criterion (HIC₁₅)** - means the calculated result of accelerometer time histories over a maximum recording period of 15 milliseconds using the following formula:

$$HIC_{15} = \left[\frac{1}{t_2 - t_1} \int_{t_1}^{t_2} a \, dt \right]^{2.5} (t_2 - t_1)$$

Where:

“a” is the resultant acceleration measured in units of gravity “g” (1 g = 9.81 m/s²);

“t1” and “t2” are the two time instants (expressed in seconds) during the impact, defining an interval between the beginning and the end of the recording period for which the value of HIC is a maximum (t2 - t1 ≤ 15 ms).

- **Mass in running order** - means the nominal mass of a vehicle as determined by the sum of the unladen vehicle mass and driver’s mass.
- **Measuring point** - The measuring point may also be referred to as “test point” or “impact point”.

In all cases, the result of the test shall be attributed to this point, independent of where first contact occurs.

“Measuring point” for the headform test means a point on the vehicle's outer surface selected for assessment. The measuring point is where the headform's profile contacts the vehicle's outer surface cross section in a vertical longitudinal plane through the centre of gravity of the headform (see Figure 36_1). It will not be coincident with the centre of the headform for contacts with an inclined surface.

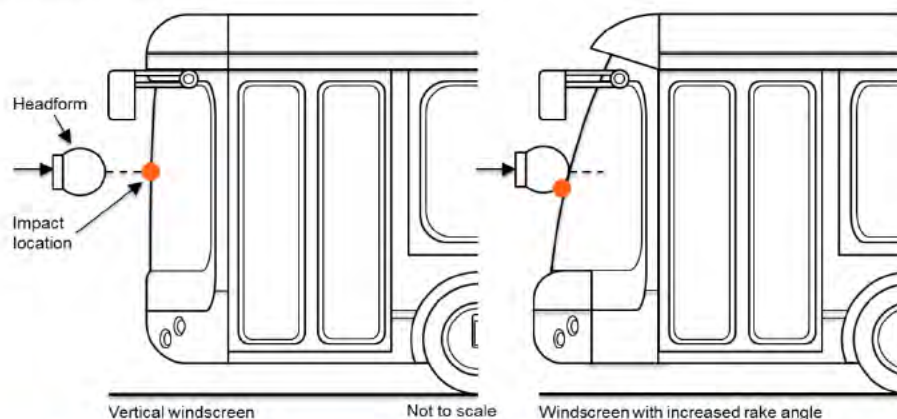

Figure 36_1: Measuring point in the vertical longitudinal plane through the centre of the headform impactor

- Maximum ride attitude** - means the vehicle positioned on a flat horizontal surface with its mass in running order, with the tyres inflated to OEM recommended pressures, the front wheels in the straight-ahead position. The suspension shall be set in normal running condition as specified by the OEM for a speed of 40 km/h.
- Minimum ride attitude** - means the vehicle positioned on a flat horizontal surface (as per the maximum ride attitude, but) with its mass increased to gross vehicle mass; the maximum mass of the fully laden vehicle based on its construction and design performances, as declared by the OEM. This shall be less than or equal to the sum of the maximum axles' (group of axles) capacity. The suspension shall be set in the running condition for this condition as specified by the OEM for a speed of 40 km/h.
- Nominal ride attitude** - means the vehicle positioned at the mid-point of the maximum and minimum ride attitudes.
- OEM: Original Equipment Manufacturer** – The company responsible for the manufacture of a completed bus, delivered to a bus operator
- Primary reference marks** - means holes, surfaces, marks and identification signs on the vehicle body. The type of reference mark used and the vertical (Z) position of each mark relative to the ground shall be specified by the OEM according to the running conditions specified along with the Minimum, Maximum and Nominal ride attitudes. These marks shall be selected so as to be able to easily check the vehicle front and rear ride heights and vehicle attitude.
- Side reference line** - means the geometric trace of the highest points of contact between a straight edge 700mm long and the sides of the vehicle, when the straight edge, held parallel to the transverse horizontal plane of the vehicle and inclined rearwards by [60°], is traversed rearwards, and maintains contact with the sides of the bus front end (Figure 36_2).

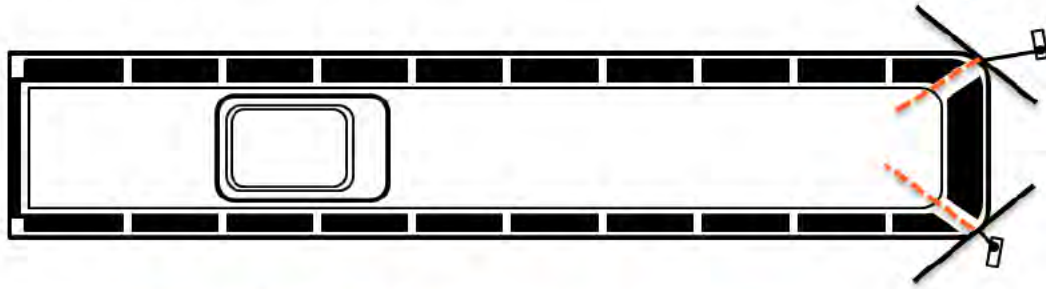

Figure 36_2a: Side reference line – plan view

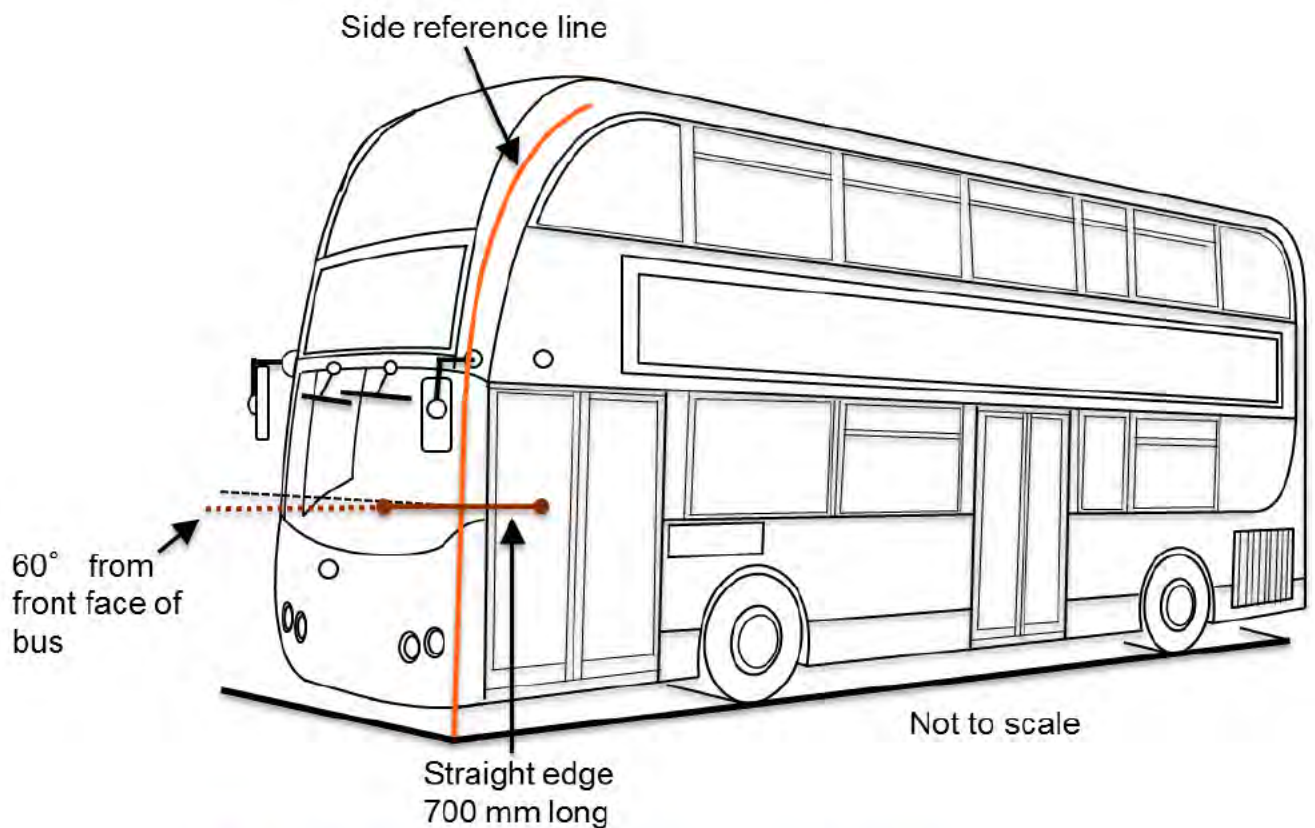

Figure 36_2b: Side reference line – front/side view

- **Test zones** - Both the child and adult headform test areas shall be divided into six test zones labelled A1, A2, ... C5, C6 with each of these test zones further sub-divided into four sub-sections labelled A-D (Figure 36_3).

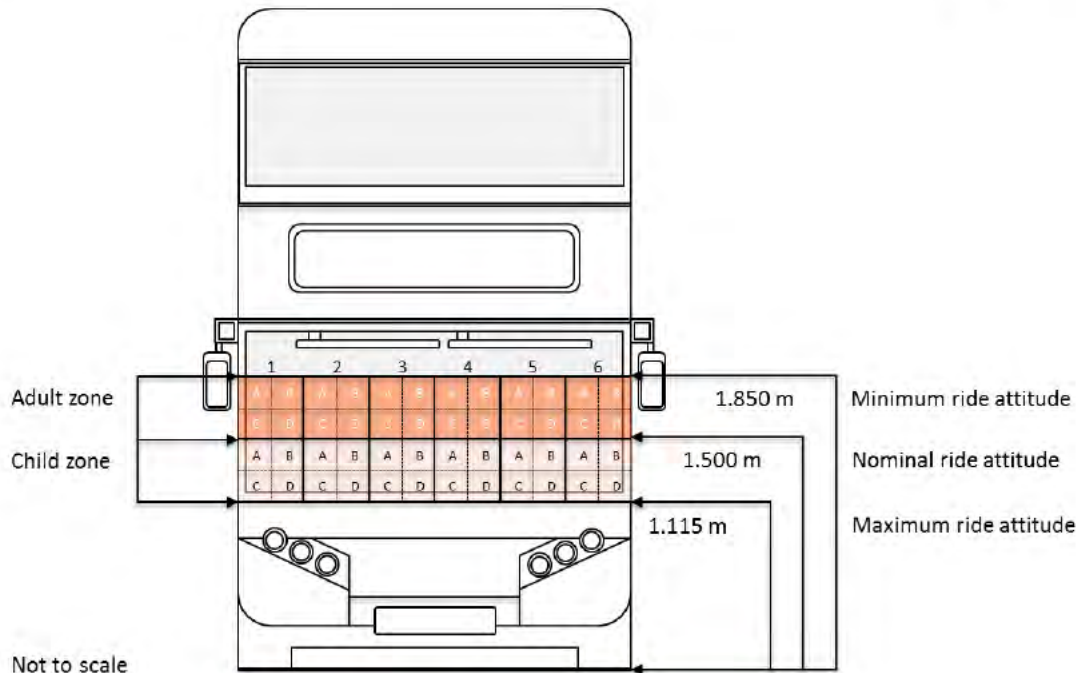

Figure 36_3: Labelling of test zones

- **Unladen vehicle mass** - means the nominal mass of a complete vehicle as determined by the following criteria:

Mass of the vehicle with bodywork and all factory fitted equipment, electrical and auxiliary equipment for normal operation of the vehicle, including liquids, tools, fire extinguisher, standard spare parts, chocks and spare wheel, if fitted.

The fuel tank shall be filled to at least 90 per cent of rated capacity and the other liquid containing systems (except those used for water) to 100 per cent of the capacity specified by the OEM.

- **Vehicle type with regard to the pedestrian protection requirements** - means a category of vehicles with front end designs which, forward of the side reference lines, do not differ in such essential respects as:
 - a) The structure,
 - b) The main dimensions,
 - c) The materials of the outer surfaces of the vehicle,
 - d) The component arrangement (external or internal),

in so far as they may be considered to have a negative effect on the results of the impact tests prescribed in this Regulation.

- **Windscreen** - means the frontal glazing of the vehicle.
- **Wrap Around Distance (WAD)** - means the geometric trace described on the outer surface of the bus front end by one end of a flexible tape, when it is held in a vertical longitudinal plane of the vehicle and traversed across the bus front end. The tape is held taut throughout the operation with one end held at



the same level as the ground reference plane, vertically below the front face of the bumper and the other end held in contact with the front structure (see Figure 36_4. The vehicle shall be either positioned in the maximum, minimum or nominal ride attitudes.

This procedure shall be followed, using alternative tapes of appropriate lengths, to describe wrap around distances of [1,115] mm (WAD1115), of [1,500] mm (WAD1500) and of [1,850] mm (WAD1850).

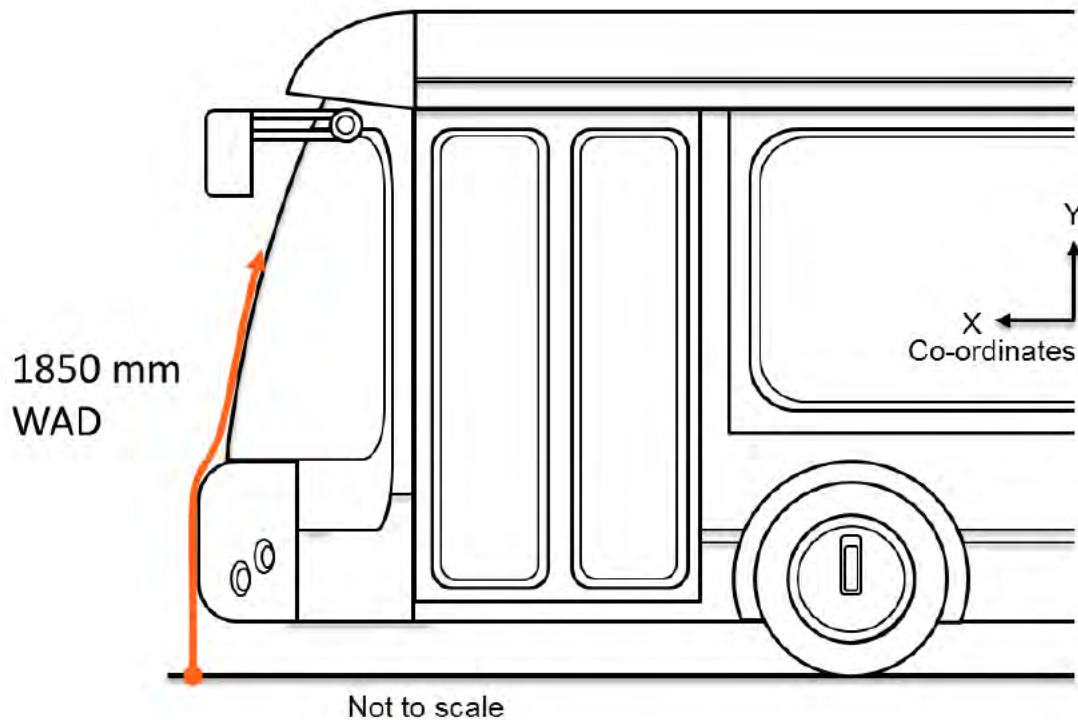

Figure 36_4: Wrap around distance measurement

7 Specifications

7.1 Minimum requirements

When tested in accordance with the test procedures in Section 8, all recorded HIC₁₅ values shall not exceed [1,350].

In addition, the Bus VRU Impact Test Performance Score (BITS) (as defined in London Bus Services limited New Bus Specification, Section 4.6.3) must be, at least [25%].

7.2 OEM selected points

The OEM may select up to three test points across both test areas to be retested. A supplementary test may then be performed to a different measuring point selected by the OEM within the same test zone (i.e. testing different sub-sections in the same



test zone is permitted). The results from these supplementary tests will be averaged with the first result when used in the following rating system.

Example:

- a) First test results in HIC = 1250
- b) OEM elected retest results in HIC = 700
- c) Mean HIC = 975

7.2.1 Bus VRU impact test performance scores (BITS)

The bus VRU impact performance score (BITS) shall be calculated for the bus front end using the following approach:

HIC₁₅ values shall be converted to points using the following scale:

- a) HIC < 700 = 2 points
- b) 700 ≤ HIC < 1000 = 1 point
- c) HIC ≥ 1000 = 0 points

The total points score shall be divided by 24 to give a value between 0% and 100%.

8 Test procedure

8.1 When performing measurements:

If the vehicle is fitted with a badge, mascot or other structure, which would bend back or retract under an applied load of maximum 100N, then this load shall be applied before and/or while these measurements are taken.

Any vehicle component which could change shape or position, other than suspension components or active devices to protect pedestrians, shall be set to their stowed position.

8.2 Impact tests

For all impact tests, the headform impactors shall meet the specifications provided in Appendix A and be certified pursuant to Appendix B. General testing conditions shall be provided pursuant to Appendix C, whilst common testing procedures are provided in Appendix D.

Tests shall be made to the bus front end within the boundaries, as defined in Section 6 of this protocol.

A minimum of six tests shall be carried out with the child headform impactor, one test to each of the six child test zones within the child headform test area (as defined in Section 6 of this protocol), at positions judged to be the most likely to cause injury.

A minimum of six tests shall be carried out with the adult headform impactor, one test to each of the six adult test zones within the adult headform test area (as defined in Section 6 of this protocol), at positions judged to be the most likely to cause injury.

Tests shall be to different types of structure, where these vary throughout the area to be assessed.



Any parts damaged by an impact must be replaced before carrying out the next test.

The selected measuring points for the child and adult headform impactors shall be a minimum of 165mm apart.

These minimum distances are to be set with a flexible tape held tautly along the outer surface of the vehicle.

No measuring point shall be located so that the impactor will impact the test area with a glancing blow resulting in a more severe second impact outside the test area.

For all child and adult headform tests, a vertical and lateral impact location tolerance of $\pm 10\text{mm}$ shall apply. This tolerance is measured along the surface of the vehicle front. The test laboratory may verify, at a sufficient number of measuring points, that this condition can be met and the tests are thus being conducted with the necessary accuracy.

The headform velocity at the time of impact shall be either $[6.94] \pm 0.2\text{m/s}$ or $[11.11] \pm 0.2\text{m/s}$. The speed shall be selected at random, with the constraint that at least half of the tests must be conducted at the $11.11 \pm 0.2\text{m/s}$ velocity. Supplementary tests shall always be performed at the same headform velocity as the first test.

The direction of impact shall be perpendicular to the lateral vertical plane of the vehicle to be tested.

9 Test Report

The Test Service shall provide a comprehensive Test Report that will be made available to TfL. The test report shall consist of three distinct sections:

- a) Reference information
- b) Confirmation of protocol compliance
- c) Performance data

9.1 Reference information

- a) As a minimum, the Test Service shall provide reference information including:
 - b) Make (trade name of OEM);
 - c) Model/Type;
 - d) Commercial name(s) (if available);
 - e) Means of identification of type, if marked on the vehicle;
 - f) Location of that marking;
 - g) Variant (if applicable);
 - h) Category of vehicle;
 - i) Name and address of OEM;
 - j) Name(s) and address(es) of assembly plant(s);
 - k) Name and address of the OEM's representative (if any);
 - l) General construction characteristics of the vehicle;



- m) Photographs and/or drawings of a representative vehicle;
- n) Bodywork;
- o) Type of bodywork;
- p) Materials used and methods of construction;
- q) Running order information;
- r) Pedestrian protection;
- s) A detailed description, including photographs and/or drawings, of the vehicle with respect to the structure, the dimensions, the relevant reference lines and the constituent materials of the frontal part of the vehicle (interior and exterior) shall be provided.

9.2 Confirmation of protocol compliance

Predominantly this item will relate to providing a description of testing completed.

The positions tested by the laboratories shall be indicated in the test report. The quadrant of each zone shall be noted as well as specific descriptions of the structures contacted.

Photographs should identify the test site before and after each test.

Records should be kept of the components changed between tests due to damage.

9.3 Performance data

Every test shall be reported along with the corresponding HIC₁₅ value.

Furthermore, the BITS score associated with each result shall be recorded as well as the overall BITS score for the bus (Table 36_1 provides a blank example of a results table).

The BITS scores should also be presented visually. Such images shall be colour coded to distinguish between the tests receiving 0, 1 or 2 points. A legend to the colour coding shall be provided within the Test Report. A hypothetical example is shown in Figure 36_5.



Table 36_1: Example table for reporting of results

Test site	Quadrant tested	HIC ₁₅	BITS score (%)
A1	A, B, C or D	XXX	YY
A2			
A3			
A3 (OEM elected retest)			
A4			
A5			
A6			
C1			
C2			
C3			
C4			
C5			
C6			
Total			

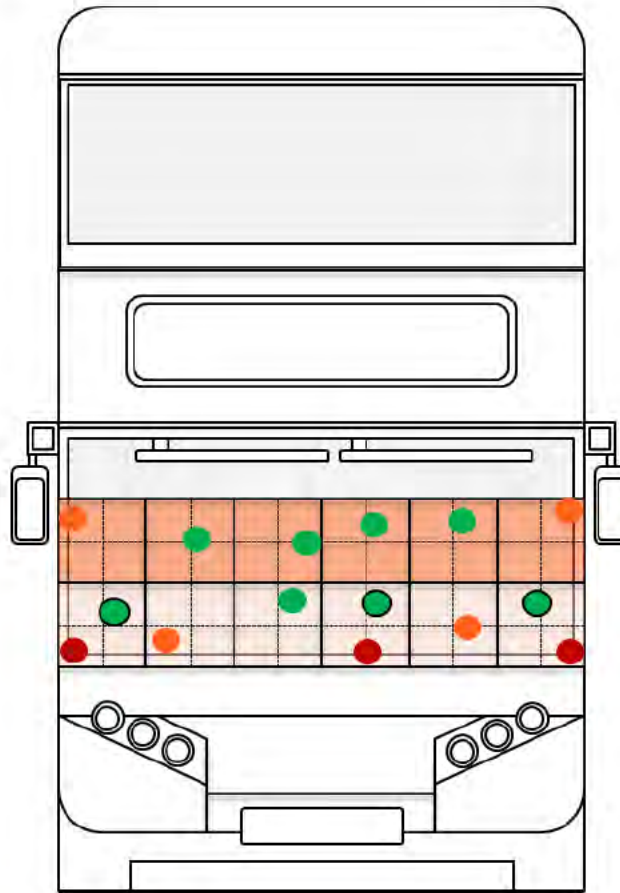

Not to scale

Figure 36_5 Example image showing test results from Bus VRU Impact Test Standard (BITS)



Annex 1 Test impactor specifications

The specifications for the test impactors are taken from the international pedestrian safety regulations for passenger cars and car-derived vans which also use these impactors. In particular, these specifications feature within UN Regulation No. 127.

Child and adult headform impactors

The child headform impactor (Figure 36_6) shall be made of aluminium, be of homogenous construction and be of spherical shape. The overall diameter shall be 165mm \pm 1mm. The mass shall be 3.5kg \pm 0.07kg. The moment of inertia about an axis through the centre of gravity and perpendicular to the direction of impact shall be within the range of 0.008 to 0.012kgm². The centre of gravity of the headform impactor including instrumentation shall be located in the geometric centre of the sphere with a tolerance of \pm 2mm.

- The sphere shall be covered with a 14mm \pm 0.5mm thick synthetic skin, which shall cover at least half of the sphere.
- The first natural frequency of the child headform impactor shall be over 5,000Hz.

Child headform instrumentation

A recess in the sphere shall allow for mounting one triaxial or three uniaxial accelerometers within \pm 10mm seismic mass location tolerance from the centre of the sphere for the measurement axis, and \pm 1mm seismic mass location tolerance from the centre of the sphere for the perpendicular direction to the measurement axis.

If three uniaxial accelerometers are used, one of the accelerometers shall have its sensitive axis perpendicular to the mounting face A (Figure 36_6) and its seismic mass shall be positioned within a cylindrical tolerance field of 1mm radius and 20mm length. The centre line of the tolerance field shall run perpendicular to the mounting face and its mid-point shall coincide with the centre of the sphere of the headform impactor.

The remaining accelerometers shall have their sensitive axes perpendicular to each other and parallel to the mounting face A and their seismic mass shall be positioned within a spherical tolerance field of 10mm radius. The centre of the tolerance field shall coincide with the centre of the sphere of the headform impactor.

The instrumentation response value CFC, as defined in ISO 6487:2002, shall be 1,000. The CAC response value, as defined in ISO 6487:2002, shall be 500g for the acceleration.

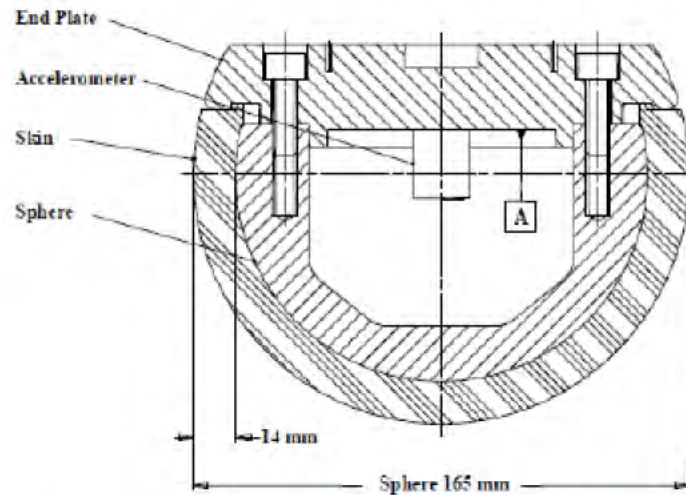

Figure 36_6: Child headform impactor

Adult headform impactor

The adult headform impactor (Figure 36_7) shall be made of aluminium, be of homogenous construction and be of spherical shape. The overall diameter is 165mm \pm 1 mm as shown in Figure 36_7. The mass shall be 4.5kg \pm 0.1kg. The moment of inertia about an axis through the centre of gravity and perpendicular to the direction of impact shall be within the range of 0.010 to 0.013kgm². The centre of gravity of the headform impactor including instrumentation shall be located in the geometric centre of the sphere with a tolerance of \pm 5mm.

- The sphere shall be covered with a 14mm \pm 0.5mm thick synthetic skin, which shall cover at least half of the sphere.
- The first natural frequency of the headform impactor shall be over 5,000Hz.

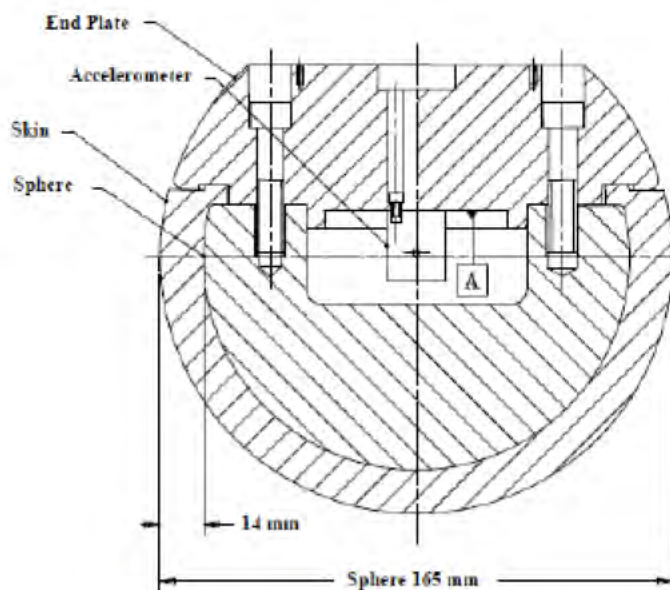

Figure 36_7: Adult headform impactor



Adult headform instrumentation

A recess in the sphere shall allow for mounting one triaxial or three uniaxial accelerometers within $\pm 10\text{mm}$ seismic mass location tolerance from the centre of the sphere for the measurement axis, and $\pm 1\text{mm}$ seismic mass location tolerance from the centre of the sphere for the perpendicular direction to the measurement axis.

If three uniaxial accelerometers are used, one of the accelerometers shall have its sensitive axis perpendicular to the mounting face A (see Figure 36_7) and its seismic mass shall be positioned within a cylindrical tolerance field of 1mm radius and 20mm length. The centre line of the tolerance field shall run perpendicular to the mounting face and its mid-point shall coincide with the centre of the sphere of the headform impactor.

The remaining accelerometers shall have their sensitive axes perpendicular to each other and parallel to the mounting face A and their seismic mass shall be positioned within a spherical tolerance field of 10mm radius. The centre of the tolerance field shall coincide with the centre of the sphere of the headform impactor.

The instrumentation response value CFC, as defined in ISO 6487:2002, shall be 1,000. The CAC response value, as defined in ISO 6487:2002, shall be 500g for the acceleration.

Rear face of the child and adult headform impactors

A rear flat face shall be provided on the outer surface of the headform impactors which is perpendicular to the direction of travel, and typically perpendicular to the axis of one of the accelerometers as well as being a flat plate capable of providing for access to the accelerometers and an attachment point for the propulsion system.



Annex 2 Certification of the impactor

The specifications for the certification of the test impactors are taken from the international pedestrian safety regulations for passenger cars and car-derived vans which also use these impactors. In particular, these specifications feature within UN Regulation No. 127.

Child and adult headform

The certified impactors may be used for a maximum of 20 impacts before re-certification. The impactors shall be re-certified if more than one year has elapsed since the previous certification or if the transducer output, in any impact, has exceeded the specified CAC.

When the headform impactors are dropped from a height of 376mm \pm 1mm in accordance with the conditions described below, the peak resultant acceleration measured by one triaxial (or three uniaxial) accelerometer (accelerometers) in the headform impactor shall be:

- a) For the child headform impactor not less than 245g and not more than 300g;
- b) For the adult headform impactor not less than 225g and not more than 275g.

The acceleration time curve shall be uni-modal.

The instrumentation response values CFC and CAC for each accelerometer shall be 1,000Hz and 500g respectively as defined in ISO 6487:2002.

The headform impactors shall have a temperature of 20 \pm 2°C at the time of impact. The temperature tolerances shall apply at a relative humidity of 40 \pm 30 per cent after a soak period of at least four hours prior to their application in a test.

Test procedure

The headform impactor shall be suspended from a drop rig as shown in Figure 36_8.

The headform impactor shall be dropped from the specified height by means that ensure instant release onto a rigidly supported flat horizontal steel plate, over 50mm thick and over 300mm x 300mm square which has a clean dry surface and a surface finish of between 0.2 and 2.0 micrometer.

The headform impactor shall be dropped with the rear face of the impactor horizontal and parallel with the impact surface. The suspension of the headform impactor shall be such that it does not rotate during the fall.

The drop test shall be performed three times.

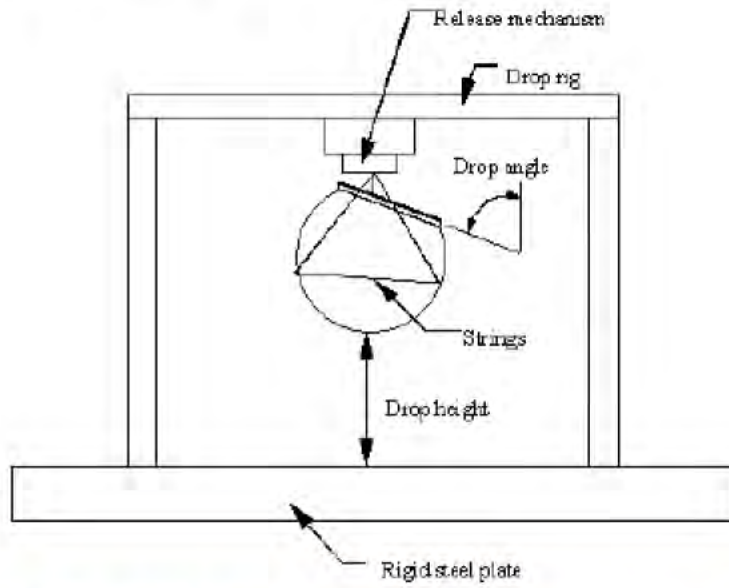

Figure 36_8: Test set-up for dynamic headform impactor certification test



Annex 3 General test conditions

Temperature and humidity

At the time of testing, the test facility and the vehicle or sub-system shall have a relative humidity of 40 per cent \pm 30 per cent and stabilized temperature of 20°C \pm 4°C.

Impact test site

The test site shall consist of a flat, smooth and hard surface with a slope not exceeding 1 per cent.

Preparation of the vehicle

Either a complete vehicle, or a cut-body, adjusted to the following conditions shall be used for the test.

- The vehicle shall be in either its maximum, minimum or nominal ride attitude, and shall be either securely mounted on raised supports or at rest on a flat horizontal surface with the parking brake applied.
- The cut-body shall include, in the test, all parts of the bus front end, all under-bonnet components and all components behind the windscreen that may be involved in a frontal impact with a vulnerable road user, to demonstrate the performance and interactions of all the contributory vehicle components. The cut-body shall be securely mounted in the maximum, minimum or nominal vehicle ride attitude.

All devices designed to protect vulnerable road users when impacted by the vehicle shall be correctly activated before and/or be active during the relevant test. It shall be the responsibility of the OEM to show that any devices will act as intended in a pedestrian impact.

For vehicle components which could change shape or position, other than active devices to protect pedestrians, and which have more than one fixed shape or position shall require the vehicle to comply with the components in each fixed shape or position.



Annex 4 Common test specifications

Propulsion of the headform impactors

The headform impactors shall be in “free flight” at the moment of impact, at the required impact velocity and the required direction of impact.

The impactors shall be released to “free flight” at such a distance from the vehicle that the test results are not influenced by contact of the impactor with the propulsion system during rebound of the impactor.

Measurement of impact velocity

The velocity of the headform impactor shall be measured at some point during the free flight before impact, in accordance with the method specified in ISO 3784:1976. The measured velocity shall be adjusted considering all factors which may affect the impactor between the point of measurement and the point of impact, in order to determine the velocity of the impactor at the time of impact. The angle of the velocity vector at the time of impact shall be calculated or measured.

Recording

The acceleration time histories shall be recorded, and HIC shall be calculated. The measuring point on the bus front end shall be recorded. Recording of test results shall be in accordance with ISO 6487:2002.



Attachment 37: Bus Impact Test

Standard Guidance Notes

1 Introduction

Bus fronts have been identified as one of the key contact causing parts of the vehicle in collisions with Vulnerable Road Users (VRU). Therefore, all bus front ends, in the region of potential head contacts, are required to have a construction that absorbs energy and protects VRUs in the event of a contact at that location on the vehicle.

As such, all buses shall have their VRU impact testing performance assessed against the associated VRU impact testing protocol. All buses shall have front ends which are energy absorbing or sufficiently compliant or frangible to meet the performance requirements.

This document sets out the guidance notes related to the assessment of VRU impact performance. These guidance notes are aimed at bus operators and manufacturers as a practical guide for implementation of the Bus Safety Standard.

These notes are for guidance only, and are not legally binding. In all circumstances, the guidance provided by a manufacturer of the bus or system shall take precedence, and these guidance notes are only for use in the absence of other information. These are not intended to be exhaustive, but to point the operators toward practical advice and questions to raise with manufacturers/suppliers.

2 Procedure background

Test procedures for the assessment of the structural interaction between passenger cars and pedestrians exist, both for type approval purposes (UN Regulation No. 127 and UN GTR No. 9) and for use in consumer assessment ratings of vehicles (e.g. Euro NCAP). These existing protocols have been used as a basis for the development of a test procedure for the assessment of the protection for Vulnerable Road Users (VRU) in impacts with buses. This procedure extends that already developed within the Aprosys Project for Heavy Goods Vehicles.

2.1 Vehicle preparation and marking

The protocol specifies the marking out of the front of the vehicle into two zones, one an adult zone, and the other a child zone. The adult zone is the area where the head of an adult pedestrian is likely to hit and the child zone is the equivalent area for a child pedestrian. The marking procedure includes allowances for changes in ride height of the vehicle and defines the “corners” of the vehicle at either side. The lower boundary of the test zone is defined with the vehicle at its normal ride height, and the upper boundary with the vehicle at its minimum ride height. The heights of the boundaries are defined based on anthropometric data, with the maximum boundary height of 1850 mm relating to the height of a 95th percentile adult male and the

minimum boundary height of 1115 mm relating to the height of a 5th percentile 6 year old. Figure 37_1 shows the marking of the two test zones.

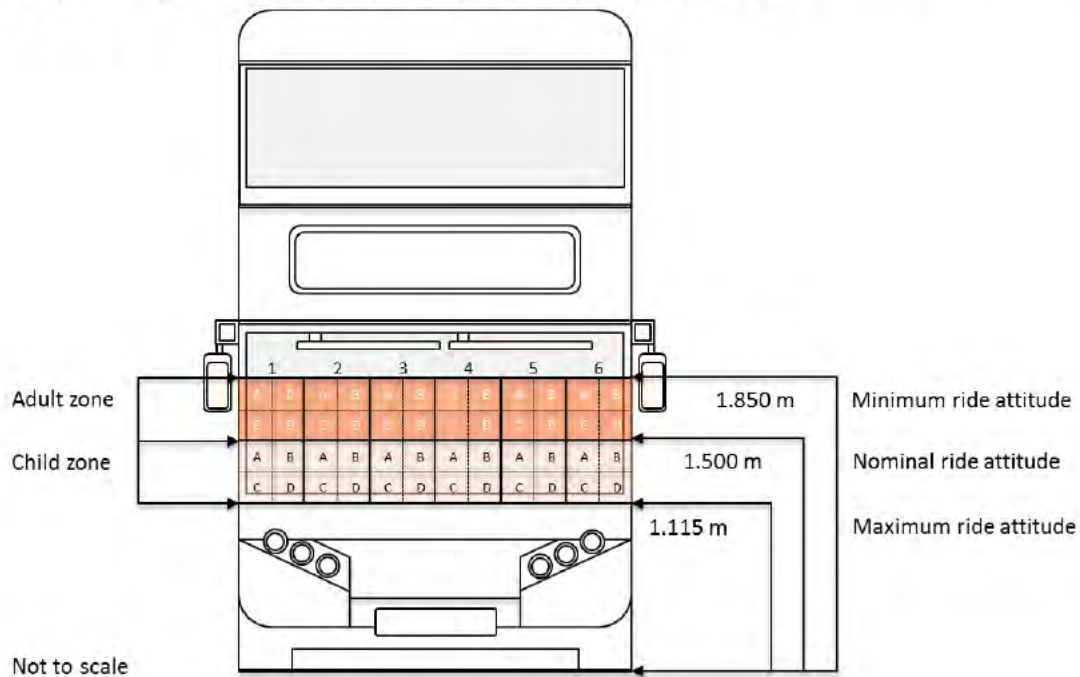

Figure 37_1: Marking out of test zones

Both the child and adult test zones are divided horizontally into six areas and labelled A1, A2.....C5, C6 as shown in 37_2. Each area is then sub-divided into quarters.

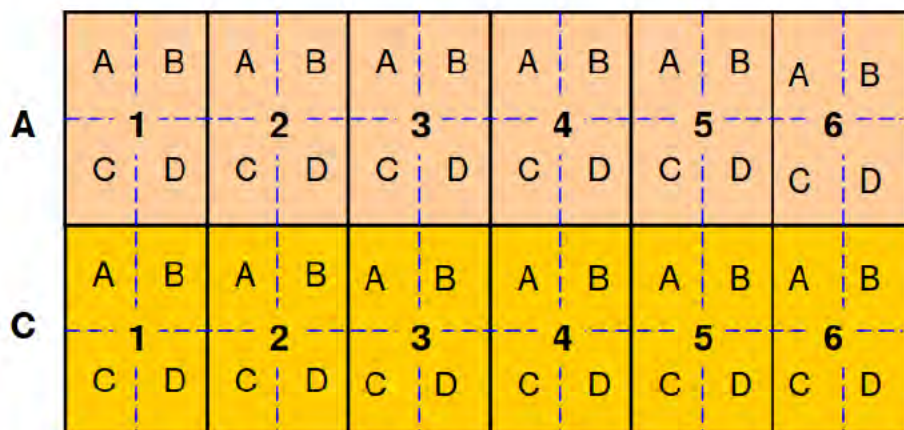

Figure 37_2: Labelling of test zones



2.1.1 Impact points

The test points are selected by the test engineer from the testing organisation (as is the case in EuroNCAP pedestrian testing of passenger cars and regulatory testing). One point must be selected from each test zone (A1, A2.....C5, C6). The test point selected should be expected to be the most injurious within that zone. In some cases, multiple test zones can cover the same structure, which is expected to have equivalent performance (e.g. the windscreen).

The vehicle manufacturer may specify up to three additional tests (one per test zone), allowing for a total maximum of 15 tests.

2.1.2 Testing

The testing is carried out with air, spring or hydraulically propelled headforms. The protocol provides details of how to position the headform. The headform is propelled at the vehicle in the x-direction parallel to the longitudinal axis of the vehicle (nominally this is normal to the surface).

The testing is carried out using an adult headform and a child headform for the respective test areas. The prime test speed used is 11.1 ± 0.2 m/s. A second speed of $[8.3 \pm 0.2]$ m/s will be used in addition for at least one of the test points in each zone. These lower speed tests will be selected at random from the proposed matrix of tests.

To avoid repeated testing of the same parts, no two tests may be carried out in the same quarter of each zone. Furthermore, no two tests are allowed within 165 mm (an adult head/headform diameter).

2.2 Assessment criteria

The 15ms Head Injury Criteria (HIC_{15}) is used for the assessment of the structural aggressivity. For each test location, up to two points can be awarded, based on the performance criteria shown below (and in the protocol). The scores for each test zone are combined to give a total out of 24. This is then scaled to a maximum score of 100% (divided by 24, multiplied by 100%).

Performance criteria.

- [$HIC < 700$ = 2 points (Green)
- $700 \leq HIC < 1,000$ = 1 point (Yellow)
- $1000 < HIC$ = 0 points (Red)]

A test failure would occur with a HIC value greater than 1350.

Also, all [new] buses shall meet the minimum bus VRU impact test performance score (BITS) requirement of [25%].

3 Selection of buses/systems

Any bus that meets the TfL Bus Vehicle Specification.

The VRU Impact Protection requirements may be assessed against a new build bus.



3.1 Compliance and warranty

A bus operator should ask to see a VRU Impact Performance test report from the bus manufacturer including the performance rating (a value between 0 and 1).

3.2 Interpreting the requirements and selecting the most effective way to fulfil them

The requirements relate to the energy-absorbing compliance or frangibility of the bus front end. In order to minimise the acceleration transmitted to the head of a vulnerable road user in the event of a collision, then the following elements should be avoided or minimised:

- **Hard:** Wherever possible yielding structures should be provided to avoid hard transfers of momentum to the head
- **Heavily featured:** As mentioned under sharpness, transitions of features on a bus front end that involve changes in angle are likely to provide natural stiffness to the structure. Therefore, ideally any changes in profile throughout the head impact areas should be progressive, offering a relatively flat bending surface.
- **Robust:** One of the most important features for components such as windscreens is their ability to fracture during an impact. The onset of fracturing should be as early in the impact event as possible to gain full advantage of that energy-absorbing failure. For glazing this could be tuned through careful selection of thickness, composition of layers and potentially the manufacturing process, etc. Advice from windscreen manufacturers may need to be sought on compliance with regulated behaviour of screens and tuning impact performance.
- **Sharp:** In accordance with the requirements of exterior projections, then sharp edges and features must be avoided on the outer surface of a vehicle (in locations where they may contact a vulnerable road user). Furthermore, tight radii tend to concentrate stiffness and hence should be avoided from the point of minimising the acceleration of a contacting head or headform.

In the first instance, the Bus Vehicle Specification (BVS) and associated impact test and assessment procedure recognises that current buses already have large flat glazed areas on the front of the vehicle which have useful frangible properties for head protection. It is expected that the minimum standard can be met with conventional design techniques. However, through the performance rating, it will recognise improvements over and above this minimum standard if further improvements and tuning of the front end structures can be provided.

3.3 Susceptibility to damage

Increasing the tendency for glazing to fracture will have an adverse consequence on the ability of a windscreen to be durable and resistant to damage. For this reason, the current levels of performance required to achieve a high impact performance rating score are conservative. The precise definitions have been set around evidence of existing performance for bus fronts. However, if a technical solution can be provided that allows lower HIC test values without deteriorating maintenance



costs and concerns and screen strength, then more stringent levels of performance could be encouraged.

3.4 Features sharing other functional requirements

To ensure that the front end of a bus performs well in other crash and failure modes, then certain requirements are placed for there to be strong structural members within the broad VRU contact area. To demonstrate crash protection for bus drivers, UN Regulation 29 (with regard to the protection of the occupants of the cab of a commercial vehicle) has been used by some manufacturers. The need to meet these structural requirements must coexist with new requirements for VRU impact protection. Experience within the passenger car industry says that the two design goals are not mutually exclusive. Effective VRU protection is at such a different level of stiffness to other crashworthiness protection that both sets of parts must be designed to act in series (with the VRU protection being placed in front of harder components). The consequence of this is that sufficient clearance must be designed between the exterior surface and underlying hard parts to allow deformation and cushioning during a VRU collision. The conflicts over packaging are recognised in this regard, but based on the experience with existing design of bus front ends are not considered to be prohibitive. Careful tuning of stiffness within deformable elements (as with car bumpers and bonnets) will minimise the clearance necessary to meet the VRU impact performance requirements.

4 Training

4.1 For test houses

Test houses accredited to undertake approval tests to UN Regulation No. 127 or UN Regulation GTR No. 9 will be considered suitable to undertake performance tests. Test houses without such accreditation will be required to demonstrate to TfL at their expense that they can achieve the same standard of testing as an accredited organisation.



Attachment 38: Bus Front End Design

– Minimum Geometric Requirements

Guidance Notes

(Vulnerable Road User (VRU) Frontal Crashworthiness)

1 Introduction

Bus fronts have been identified as one of the key injury-causing contact areas of the vehicle in collisions between buses and Vulnerable Road Users (VRU). Therefore, all bus front ends are required to have a global geometric design that both improves protection for VRUs during the primary impact of a collision and reduce the risks of VRUs being run over subsequently.

As such, all [new] buses shall have a front end design that complies with the Vulnerable Road User (VRU) crashworthiness minimum bus front end geometry requirements for both vertical rake and wraparound windscreen curvature.

This document sets out the guidance notes related to the assessment of the global bus front end geometry and specifically, with respect to the minimum requirements contained in Section 4.6.1 of the Bus Vehicle Specification. These guidance notes are aimed at bus operators and OEMs as a practical guide for implementation of the requirements specified by the Bus Vehicle Specification.

These notes are for guidance only and are not legally binding. In all circumstances, the guidance provided by a OEMs of the bus or system shall take precedence, and these guidance notes are only for use in the absence of other information. These are not intended to be exhaustive, but to point the operators toward practical advice and questions to raise with OEMs/suppliers.

For full understanding of this Attachment it should be read in conjunction with the New Bus Specification, Section 4.6.1

2 Selection of buses/systems

From 2021 until 2024, all [new] buses shall have a front end geometry that complies with the minimum bus front end geometry requirements for both vertical rake angle and wraparound windscreen curvature. Therefore, selection can be any bus model or variant that is compliant with these specifications.



2.1 Intention of the requirements

The minimum bus front end geometry requirements intend to encourage bus front end designs that implement a wraparound windscreen design (as opposed to a box-fronted front end, where the A-pillars are located at the very front edges of the windscreen), as well as a positive vertical rake angle (i.e. the vertical angle).

It was found in research by TRL that impacts against the more compliant wraparound windscreen material resulted in a considerable reduction in VRU injury risk, relative to impacts against the much stiffer A-pillar structures. This was coupled with a significant proportion of VRUs impacting the A-pillar region during collisions, particularly on the passenger side. Furthermore, run over risks were found to increase during collisions with bus front end designs that included a section with a negative vertical rake, due to the VRU essentially being pushed under the bus by these sections.

Of the bus model variants investigated by TRL, the wraparound windscreens with a radius of curvature of ~150 mm at the edge of the windscreen were found to be safer than traditional windscreen designs (where A-pillars are located at the front of the bus). As the structural stiffness of these wraparound sections are determined by the radius of curvature, a radius of curvature of less than 150 mm at the edges of the wraparound windscreen is considered undesirable, as this stiffens the structure and causes greater harm to the VRU if impacted. Similarly, negative vertical rake angles are considered undesirable, due to the increased run over risks that they present to VRUs.

These requirements therefore seek to promote the deployment of [new] buses into the TfL network with wraparound windscreen designs and positive vertical rakes, as these are intrinsically safer than traditional windscreen designs. To control for the stiffness of wraparound windscreens, these requirements ensure a minimum permissible radius of curvature of 150 mm between 0.75-2.0 m. To ensure that no bus results in a design that pushed VRUs under the bus, these requirements ensure minimum vertical rake angles of at least 1° between 0.75-1.2 m and 4° between 1.2-2.0 m.

2.2 Interpreting the requirements and selecting the most effective way to fulfil them

The minimum requirements are intended to dictate a progressive surface geometry for the bus front end to bring about improvements in vulnerable road user protection. It is expected that the surface is broadly continuous in this regard. However, it is also recognised that necessary features are incorporated in the bus front end for functional reasons and styling. Experience from the car industry suggests that small projections and protrusions can be used to provide localised areas of angled surfaces. The most effective vulnerable road user protection will be realised if the geometry requirements are adopted generally, the greater the size of the areas presenting that angle then the more effective the measure will be.

2.3 Compliance checks

It is expected that compliant vehicles may be selected from the current available TfL bus fleet. On consultation with OEMs, it was agreed that all current bus model



variants with a wraparound windscreen design should have a radius of curvature and vertical rake that comply with these requirements.

Bus operators should ask to see documentary evidence of compliance with these requirements. Compliance may be established through either a CAD-based approach or physical testing. Whichever approach is adopted, a dossier of inspection points and measurements should be provided to assure compliance.

3 Training

3.1 For Test Services

The nature of verifying compliance with the requirements will depend on whether it is demonstrated through CAD or physical testing.

For CAD assessments, appropriate sections should be cut to demonstrate bus front end geometry in a way that can be visualised against the requirements. Any inspection should be facilitated by applying tangents or radii to the surface where the appropriate angles of rake or radius of curvature can be viewed. It should be possible for the inspection to identify the worst-case angle throughout the section.

For physical inspections, the vertical rake can be measured with an inclinometer. Here it should be noted that the footprint for these measurements should be $236 \pm 5 \text{ mm} \times 236 \pm 5 \text{ mm}$. This is to ensure that only the global geometric features of the bus are considered by these requirements and that smaller features are considered to not have a significant effect on the outcomes of VRU collisions. Test houses undertaking approval tests to UN Regulation No. 127 or UN Regulation GTR No. 9 will already possess the capability to apply a 236 mm x 236 mm probe to the front of a car in order to determine the bumper corners.

The radius of curvature of the wraparound windscreen may be physically tested using a radius gauge. This gauge may be used as a go/no-go gauge, by setting it to 150 mm and observing whether any aspect of the tested wraparound windscreen edge has a radius of curvature smaller than the gauge.

4 Ongoing observations

4.1 Glare and visual artefacts

In discussions around these geometric requirements, two issues have been raised as potential disbenefits associated with the improvements for VRU protection. These are:

1. That the vertical rake of the windscreen may refract light from overhead sources (such as street lights and the sun) creating glare for the driver.
2. That the horizontal curvature of the windscreen may create apparitions or visual artefacts that distort direct vision for the driver, particularly towards the corners of the screen.

As these minimum requirements do not take bus front end geometries beyond that of existing designs, it is considered that these potential issues are not perceived to be



critical factors above that already accepted as common practice within the current fleet. However, operators should be mindful of the potential and will be expected to log and feedback any potential issues, if substantiated reports become available.

Attachment 39: Bus Front End Geometry Test and Assessment Protocol

1 Introduction

This document presents a procedure, hereon referred to as the Front End Geometry Test (FEGT), for objectively measuring the global geometry of a bus front end for the purposes of requiring a design that optimises the kinematics of collisions between bus front ends and vulnerable road users to mitigate the risks of injury and run-over events.

For full understanding of this Attachment it should be read in conjunction with the New Bus Specification, Section 4.6.2 and Attachment 40 - Bus Front End Design – Enhanced Geometric Requirements Guidance Notes

2 Scope

This protocol applies to all new buses intended for service under contract to TfL that are passenger vehicles with a maximum mass exceeding 5 tonnes and a capacity exceeding 22 passengers. The passenger vehicles will be capable of carrying seated but unrestrained occupants and standing occupants. Such vehicles are categorised by the Consolidated Resolution on the Construction of Vehicles (R.E.3) as M₃¹; Class I, Class II.

3 Purpose

The purpose of this test and assessment protocol is to bring about an improvement in the global geometry of the front end of buses which have been identified as a principle cause of injuries when involved in collisions with vulnerable road users (pedestrians, cyclists and motorcyclists).

The vehicles tested under the Front End Geometry Test (FEGT) are representative of the majority of buses in circulation in the urban environment where there is a significant potential for bus collisions with pedestrians and other vulnerable road users.

4 Normative References

The following normative documents, in whole or in part, are referenced in this document and are indispensable for its application. For dated references, only the edition cited applies. For undated references, the latest edition of the referenced document (including any amendments) applies.

¹ As defined by European Type Approval Framework Directive 2007/46/EC



- London Bus Service Limited New Bus Specification Section 4.6.2
- London Bus Service Limited New Bus Specification – Attachment 40: Bus Front End Design – Enhanced Geometric Requirements Guidance Notes
- Directive 2007/46/EC of the European Parliament and of the Council establishing a framework for the approval of motor vehicles and their trailers, and of systems, components and separate technical units intended for such vehicles.
- Regulation (EU) 2018/858 of the European Parliament and of the Council of 30th May 2018 on the approval and market surveillance of motor vehicles and their trailers, and of systems, components and separate technical units intended for such vehicles, amending Regulations (EC) No 715/2007 and (EC) No 595/2009 and repealing Directive 2007/46/EC.

5 Definitions

For the purposes of this protocol:

- **A-pillar** - means the foremost and outermost roof support extending from the chassis to the roof of the vehicle.
- **Bus front end** - means all outer structures of the front end of the vehicle exposed to a potential collision with a VRU. It may therefore include, but is not limited to, the bumper, the bonnet or grille, scuttle, wiper spindles, lower windscreen frame, the windscreen, the windscreen header and the A-pillars.
- **Bus front end geometry envelope** - means the range of horizontal angles and vertical rake angles for each test position, outside of which the bus front end would be considered to be non-compliant.
- **Driver mass** - means the nominal mass of a driver that shall be [68] kg.
- **Front End Geometry Performance Evaluation Tool** - means the spreadsheet tool used to assess the safety performance of the global geometric characteristics of the bus front end
- **Frontal plane** - means a plane perpendicular to the median longitudinal plane of the vehicle and touching its foremost point, disregarding the projection of devices for indirect vision and any part of the vehicle greater than 2.0 m above the ground.
- **Ground reference plane** - means a horizontal plane that passes through the lowest points of contact for all tyres of a vehicle with its mass in running order. If the vehicle is resting on the ground, then the ground level and the ground reference plane are one and the same. If the vehicle is raised off the ground such as to allow extra clearance, then the ground reference plane is above ground level; and if the vehicle (perhaps a test sample) is lower than it would be in running order, then the ground reference plane is below the ground level.
- **Global coordinate system** - means the coordinate system located with its origin at the intersect of the longitudinal median plane of the vehicle, the frontal plane and the ground reference plane and its axes orientated such that



the positive X-axis is directed forward, the positive Y-axis is directed towards the offside of the vehicle and the positive Z-axis is directed upward.

- **Horizontal angle** - means the angle measured at each test point between the frontal plane of the bus and the tangent to the bus front end structures in a plane parallel to the horizontal plane of the vehicle.
- **Inboard** - means in a direction toward the median longitudinal plane.
- **Lower test reference line** - means the geometric trace on the bus front end of a horizontal plane located at a wrap around distance of 750 ± 10 mm above the ground reference plane.
- **Mass in running order** - means the nominal mass of a vehicle as determined by the sum of the unladen mass and driver's mass.
- **Measuring point** - means the location on the bus front end at which the horizontal angle and vertical rake angle values are measured.
- **Median longitudinal plane** - means the centreline of the subject vehicle parallel to the forward direction of travel.
- **Nearside** - means the left-hand side (i.e. passenger side) of the subject vehicle.
- **Offside** - means the right-hand side (i.e. driver side) of the subject vehicle.
- **Outboard** - means in a direction away from the median longitudinal plane.
- **Side reference line** - means the geometric trace of the most outboard points of contact between a straight edge 700mm long and the sides of the vehicle, when the straight edge, held parallel to the transverse horizontal plane of the vehicle and inclined rearwards by 75° , is traversed rearwards to contact the sides of the bus front end (Figure 39_1).

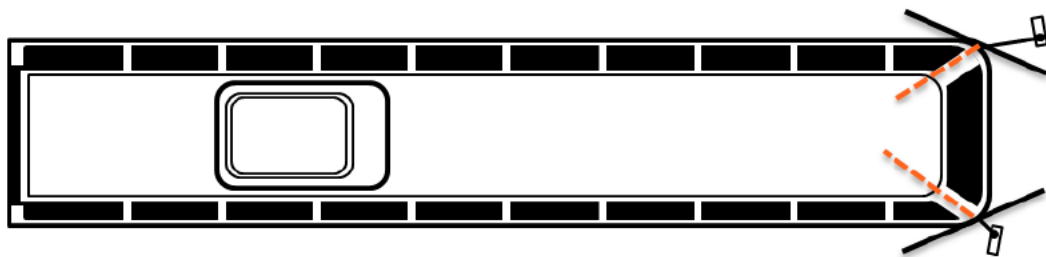

Figure 39_1a: Side reference line – plan view

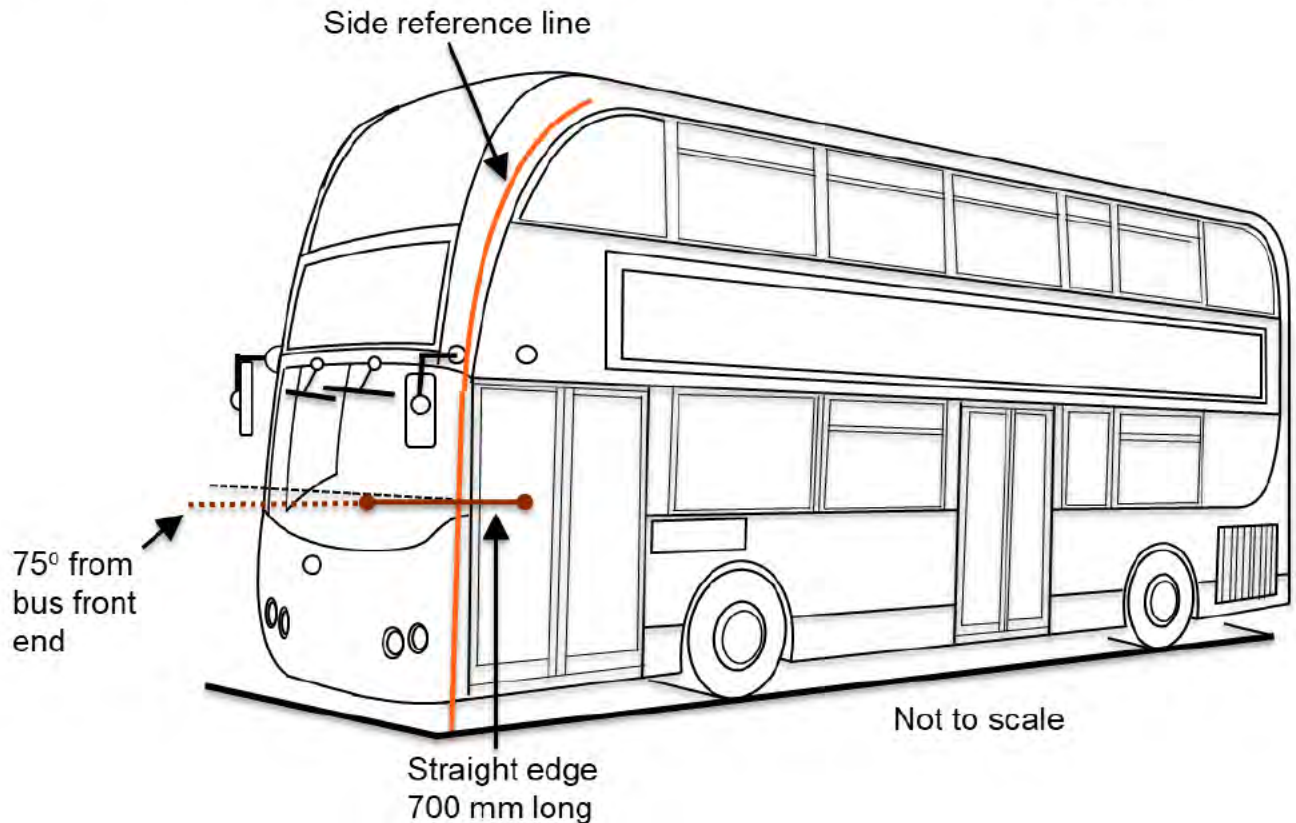

Figure 39_1b: Side reference line – front/side view

- **Subject vehicle** - means the vehicle being tested.
- **Test position** - means the position used to locate the measuring point in the Y-axis on the bus front end. Each test position shall extend between the lower and upper test reference lines. Five test positions are specified:
 - Outboard nearside test position (P1), with test points located at a horizontal wrap around distance of 150 mm inboard from the nearside side reference line.
 - Inboard nearside test position (P2), with test points located at a horizontal wrap around distance of 725 mm outboard from the median longitudinal plane and toward the nearside.
 - Central test position (P3), with test points located on the median longitudinal plane.
 - Inboard offside test position (P4), with test points located at a horizontal wrap around distance of 725 mm outboard from the median longitudinal plane and toward the offside.
 - Outboard offside test position (P5), with test points located at a horizontal wrap around distance of 150 mm inboard from the offside side reference line.
- **Test zone** - area on the bus front end structures bounded by the upper and lower test reference lines and the nearside and offside reference lines.



- **Unladen mass** - means the nominal mass of a complete vehicle as determined by the following criteria:
 - Mass of the vehicle with bodywork and all factory fitted equipment, electrical and auxiliary equipment for normal operation of the vehicle, including liquids, tools, fire extinguisher, standard spare parts, chocks and spare wheel, if fitted.
 - The fuel tank shall be filled to at least 90 per cent of rated capacity and the other liquid containing systems (except those used for water) to 100 per cent of the capacity specified by the OEMs.
- **Upper test reference line** - means the geometric trace on the bus front end of a horizontal plane located at a wrap around distance of 2000 ± 10 mm above the ground reference plane.
- **Vertical rake angle** - means the angle measured at each test point between the frontal plane of the bus and the tangent to the bus front end structures in a plane parallel to the median longitudinal plane of the vehicle.
- **Vehicle type with regard to enhanced geometry requirements** - means a category of vehicles with front end designs which, within the test zone, do not differ in such essential respects as:
 - The global geometric dimensions,
 - The external component arrangement,in so far as they may be considered to have a negative effect on the results of the impact tests prescribed in this Regulation.
- **Vulnerable road user (VRU)** - means an adult or child pedestrian or an adult or child cyclist
- **Wrap around distance** - means the geometric trace described on the outer surface of the bus front end structures by a flexible tape, when it is held in the vertical or horizontal plane of the vehicle and traversed across the bus front end. The tape is held taut throughout the operation with one end held at the origin of the measurement (see Figure 39_2).

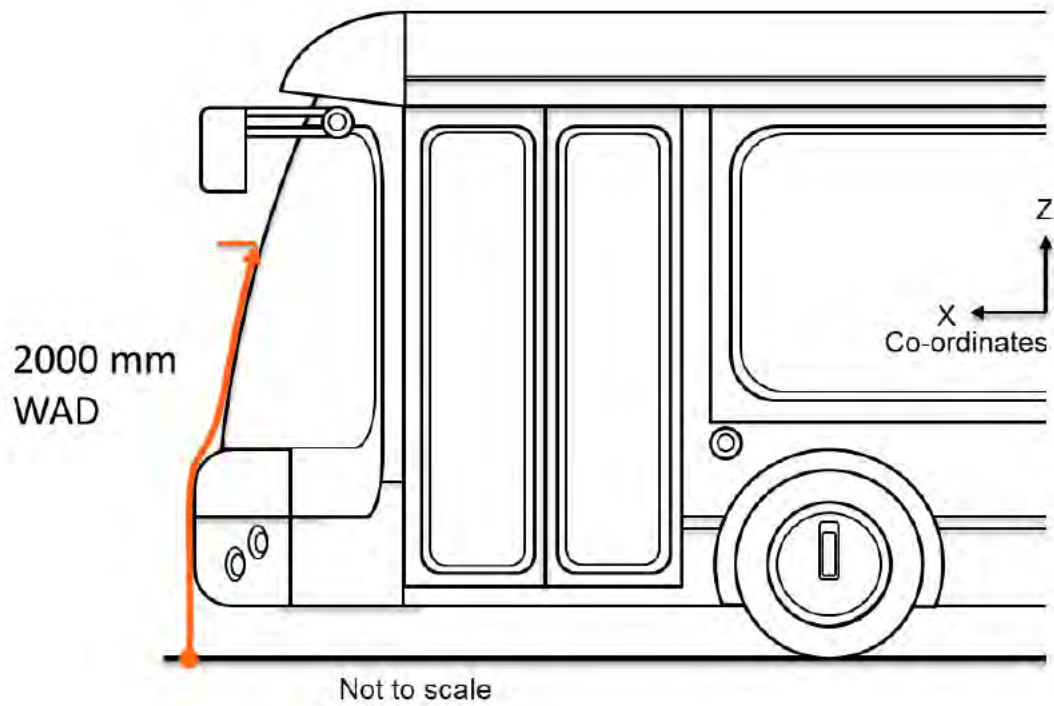

Figure 39_2: Wrap around distance measurement



6 Specifications

When tested in accordance with the test procedures in Section 7, the following minimum requirements shall be met:

- a) All horizontal and vertical rake angles shall be compliant with the bus front end geometry envelope boundaries defined in Section 0.
- b) A weighted bus front end geometry score (FEGS) of 0% (as defined in Section e)) shall be exceeded.
- c) There shall be no more than eight safety performance criteria scores with a value of 0.

Bus front end geometry envelope boundaries

- a) The bus front end geometry shall be compliant with the following boundary conditions:
- b) Vertical rake angles for all measuring points at all test positions (P1-P5) shall be no less than 4° and no greater than 23°.
- c) Horizontal angles for all measuring points at the outboard test positions (P1 and P5) shall be no less than 20° and no greater than 33°.
- d) Horizontal angles for all measuring points at the inboard test positions (P2 and P4) shall be no less than 11° and no greater than 18°.
- e) Weighted bus front end geometry score (FEGS)

The weighted FEGS shall be calculated for each subject vehicle using the following approach:

- a) Safety performance scores shall be calculated for all safety performance measures (head injury risk, thoracic injury risk and run-over risk) at each impact position and each impact velocity using the Front End Geometry Performance Evaluation Tool provided.
- b) The Front End Geometry Performance Evaluation Tool shall then be used to extract the FEGS for the bus front end of the subject vehicle.
- c) The FEGS shall then be ranked according to the following star rating approach:
 - 1) 0 star: $FEGS \leq 0\%$
 - 2) 1 star: $0\% < FEGS \leq 10\%$
 - 3) star: $10\% < FEGS \leq 20\%$
 - 4) star: $20\% < FEGS \leq 30\%$
 - 5) star: $30\% < FEGS \leq 40\%$
 - 6) star: $FEGS > 40\%$



Vehicle types may be exempt from these requirements, should documentary evidence be provided to demonstrate to the Test Service how the geometric design of the subject vehicle bus front end reduces the risks of VRU injuries and run-overs relative to current bus designs.

A simulation based test and assessment approach shall be provided as evidence.

Although the OEMs has the responsibility to ensure such evidence provides sufficient assurance of real-world improvements in VRU injury and run-over risks, guidelines on a simulation based testing approach are provided in 0.

7 Test procedure

When performing measurements:

- a) If the vehicle is fitted with a badge, mascot or other structure, which would bend back or retract under an applied load of maximum 100N, then this load shall be applied before and/or while these measurements are taken.
- b) Any vehicle component which could change shape or position, other than suspension components or active devices to protect pedestrians, shall be set to their stowed position.

Vehicle set up:

- a) The vehicle shall be tested with the mass in running order.
- b) The side, upper and lower reference lines and the test positions shall be marked on the subject vehicle.
- c) Three measuring points, with at least 500 mm wrap around distance between them, shall be marked on the vehicle for each test position.

Bus front end geometry measurements:

- a) At each measuring point, the vertical rake angle and horizontal angle shall be assessed.
- b) To ensure only the global geometric features of the bus front end are tested, these angles shall be assessed using a 236 ± 5 mm x 236 ± 5 mm rectangular plane, with its centre placed against the surface of the bus at the measuring point.
- c) Assessment of weighted front end geometry scores (FEGS):
- d) Input the vertical rake angle, to the nearest degree, for all measuring points at all test positions (P1-P5) to the Front End Geometry Performance Evaluation Tool.
- e) Input the horizontal angle, to the nearest degree, for all measuring points at the inboard and outboard test positions (P1, P2, P4 and P5) to the Front End Geometry Performance Evaluation Tool.

Extract and report the following criteria:

- a) The weighted FEGS.
- b) The number of safety performance criteria scores with a value of 0.
- c) The bus front end geometry envelope compliance status.



- d) The star rating score.

Approaches other than the above procedure, such as CAD based methods, may be considered as equivalent by the Test Service, should documentary evidence be provided to verify that the requirements of the test procedures described in this Section have been met.

8 Test Report

The Test Service shall provide a comprehensive Test Report that will be made available to TfL. The test report shall consist of three distinct sections:

- a) Reference information
- b) Confirmation of protocol compliance
- c) Performance data

8.1 Reference information

As a minimum, the Test Service shall provide reference information including:

- a) Make (trade name of OEMs)
- b) Model/Type
- c) Commercial name(s) (if available)
- d) Means of identification of type, if marked on the vehicle
- e) Location of that marking
- f) Variant (if applicable)
- g) Category of vehicle
- h) Name and address of OEMs
- i) Name(s) and address(es) of assembly plant(s)
- j) Name and address of the OEMs's representative (if any)
- k) General construction characteristics of the vehicle
- l) Photographs and/or drawings of a representative vehicle
- m) Bodywork
- n) Type of bodywork
- o) Materials used and methods of construction
- p) Running order information
- q) A detailed description, including photographs and/or drawings, of the vehicle with respect to the structure, the dimensions, the relevant reference lines and the exterior bodywork of the frontal part of the vehicle shall be provided



8.2 Confirmation of protocol compliance

- a) Predominantly this item will relate to providing a description of testing completed.
- b) The measuring points tested by the laboratories shall be indicated in the test report. The test position and height from the ground plane of each measuring point shall be noted, as well as specific descriptions of the structures at the test point.
- c) Photographs should identify the measuring points before testing.

8.3 Performance data

All vertical rake and horizontal angles for each measurement point shall be reported, alongside their positions relative to the global coordinate system (Table 39_ provides a blank example template of this table).

The safety performance criteria scores for each test position, vehicle speed and injury criteria shall be reported, taking the values reported by the Front End Geometry Performance Evaluation Tool (Figure 39_3).

The weighted FEGS, the number of safety performance criteria scores with as value of 0, the bus front end geometry envelope compliance status and the star rating shall be reported, taking these values reported by the Front End Geometry Performance Evaluation Tool (Figure 39_3).

Table 39_1: Example table for reporting of measurement point results

Test Position	Measurement Point Y Position	Measurement Point Z Position	Vertical Rake Angle	Horizontal Angle
P1-1	WWW mm	XXX mm	YY°	ZZ°
P1-2				
P1-3				
P2-1				
P2-2				
P2-3				
P3-1				
P3-2				
P3-3				
P4-1				



P4-2				
P4-3				
P5-1				
P5-2				
P5-3				

Safety Performance Criteria Scores		
HIC	Rib Deflection (mm)	Run-Over Proximity (m)
1	0	1
0	1	2
1	1	2
1	1	1
1	2	0
1	2	1
0	2	0
1	2	2
0	1	1
2	2	2
2	2	1
2	2	2
2	2	0
0	1	1
1	2	2

Weighted Front End Geometry Score	26.7%
Safety Performance Criteria Scores with a Value of 0	8
Front End Geometry Envelope Compliance	PASS
Bus Front End Geometry Star Rating	3

Figure 39_3: Example image showing results from front end geometry performance evaluation tool



Annex 1 - Simulation based testing guidelines

1 Introduction

The Vulnerable Road User (VRU) crashworthiness enhanced bus front end geometry requirements are intended to improve protection for VRUs during the primary impact of a collision and reduce the risks of VRUs being run over subsequently.

The clause on simulation evidence in the requirements permit an alternative pathway for compliance, whereby the intentions of these enhanced geometry requirements may be satisfied via a simulation based approach.

While ultimately the responsibility for ensuring sufficient real-world improvements in VRU injury and run-over risks remains with the OEMs, this Annex sets out a series of guidelines for simulation based approaches to be considered as equivalent evidence when compared to the requirements of the previously defined bus front end geometry test and assessment protocols.

2 Simulation Set Up Guidelines

2.1 Bus model validation

The geometry of the bus front end and structures is expected to come from CAD files of the bus and formed of suitably accurate representations of at least the bus front end components.

The material properties and the simulated structures should be tuned in a correlation exercise in order to develop a representative material model. This should be correlated against test data; for instance, comparing headform kinematics between physical and simulated tests against the flat, curved and/or wraparound areas of the windscreen. This model validation should occur before the simulations are performed to satisfy the requirements of the simulation approach.

It is recognised that there is a balance to be struck between quality of the simulation output and computational efficiency. However, it is expected that the simulation output is validated against physical (test) evidence and that this validation forms part of the simulation evidence package. It is anticipated that the testing is based on designs produced by the OEMs, rather than third party data, so that the correlation in bus front end response and VRU protection can be understood in terms of the detailed design approach adopted by the OEMs.

Pilot simulations should be used to assess whether the model produces a range of responses that are reasonable and reliable. Things to consider are:

- All VRU body parts are capable of contacting, where appropriate, with the bus front end components with a representative response during the simulations
- There are no simulation artefacts that significantly govern the response of the model (i.e. penetration through surfaces).

This approach may accept developmental models to support the validation as long as they are representative of the final design of the subject vehicle; it doesn't have to be the final production (pre-production) design.



2.2 VRU surrogate models

As there is a need to avoid protection that is highly optimised for any single VRU size or type (e.g. a 50th percentile male pedestrian). Instead, the design approach to safety should intend to provide equivalent protection across all vulnerable road users.

In the evidence package it is recommended that the simulations generally concentrate on a single size/type of VRU model, such as the 50th percentile male pedestrian. This VRU model should be used to look for and demonstrate any improvements in safety over the baseline case.

Supplementing this there should then be an initiative to explore potential degradation in safety performance for other sizes or types of VRU.

The choice of other VRUs to be considered in the modelling should follow a sensible review of structural changes in the front end design of the bus. For instance, if there is a discontinuity in the surface profile around 1.5 m from the road, then testing with a large child or small adult would be important to explore and understand the implication of that profile for frontal crashworthiness and VRU protection. Cyclist models shall also be investigated.

The most representative approximation of a VRU should be sought in developing the simulation evidence. This may be taken to infer the use of detailed human body models (for example the Toyota Total Human Model for Safety (THUMS²), or the Global Human Body Modelling Consortium model (GHBM³)). However, it is appreciated that not all suppliers of simulation capabilities have access to these detailed human body models (and the associated compute time) at reasonable costs. Therefore alternatives may be sought.

In prior work TRL has gained experience with frontal VRU crashworthiness simulations with a standing or cycling variant of a Hybrid III crash test dummy model. Simulation validity (biofidelity) was observed to improve with the addition of a more compliant shoulder and chest. Therefore, when using alternative VRU surrogates, such as crash test dummy models, it is recommended that the at least the thorax and shoulder of the surrogate have been developed for use in VRU or side impact specific simulations.

2.3 VRU manoeuvres

There is also a need to avoid protection that is highly optimised for any one type of VRU motion (walking, running or cycling behaviour). It is important to consider that in a potential collision with a VRU, their behaviour could be from a relatively wide variety of walking, running or cycling speeds and with any horizontal travel direction vector. It is important to have confidence that these variations do not lead to poor interactions with the bus front end which would give a concern for VRU frontal crashworthiness.

Several impact positions should be evaluated across the width of the bus front end. Whether or not the bus is symmetrical about the central vertical and longitudinal plane, it is likely to require testing the bus front on the right and left for a VRU travelling from one side to the other. This is because the VRU will have its own

² <https://global.toyota/en/newsroom/corporate/26497281.html>

³ <https://www.elemance.com/>



velocity which may influence the interaction with the bus front end and the rebound speed and direction. As such, a minimum of five test positions is recommended, as specified in the previous requirements, to account for horizontal curvature changes across the bus front end.

The position of the legs (for instance, where they are in the 'gait' cycle) of the VRU has also been shown to influence the interaction of the VRU with the bus front end. This potential variation in interaction should also be built into the simulation matrix so that confidence is given to the range of outputs and their ability to account for this effect. This will help in understanding the sensitivity of the design to likely collision scenarios and should be used to capture the worst case for protection.

2.4 Simulation boundary conditions

There is a need to avoid protection that is highly optimised for a single set of boundary conditions (e.g. collision speeds). The boundary conditions for the simulations should cover the range of realistic inputs. This will mean evaluating simulation outcomes with deliberately selected:

- Closing speeds
 - With representative bus speeds
 - For example, a range of 10 to 30 mph is reasonable based on travel speeds and collision case data
 - A single evaluation point could be used (e.g. 20 mph) for the major part of a simulation matrix assuming that the variation with speed was shown to be predictable in a subset of the tests
 - With representative travel speed for the VRUs
 - A range of 2 to 8 m/s could be used to represent reasonable walking and running behaviours of a pedestrian
 - Again, a smaller set of speeds could be used in the simulation matrix if it could be demonstrated that worst case interactions were understood in the derivation of that matrix
- Contact friction
 - Some friction with the ground is necessary
 - 0.6 has been used as the coefficient of friction in prior research work
- Braking vehicle dynamics
 - A representative braking rate shall be selected for use in determining the risk of a run-over, with -3.5 m/s^2 previously used. To simplify the braking response, this may be assumed as a constant braking rate (i.e. no need to model driver reaction and brake build up times).
 - It is suggested that some diving (forward pitching) of the bus front can be expected in many collision scenarios due to the pre-impact braking response
 - A representative forward pitch for the subject vehicle should be chosen for simulations to reflect potential collision scenarios and possible worst case interactions for the VRU
- Start and finish times for simulation runs
 - The start time should be prior to the first contact between bus and VRU
 - The finish time should allow adequate prediction of VRU throw characteristics to assess the risk for the bus running over the VRU after the primary interaction



3 Assessment of safety performance

The objective of the VRU crashworthiness safety measure is to assess injury causing consequences and demonstrate that a design for a bus front improves protection for VRUs during the primary impact, whilst reducing the risks of VRUs being subsequently run over. The requirements of this alternative compliance path are that the simulations provide an assessment of both direct contact injury risk and the subsequent 'run-over' risk.

To demonstrate safety performance improvements any new subject vehicle shall be compared against a database of responses built around a bus front end design that is representative of current/past geometries and structures. This shall be used to assess head and chest injury risk and the subsequent risk of being run-over for the VRU, due to these injury mechanisms being associated with the greatest risks of fatal and severe VRU collision injuries.

Although many injury risk metrics for each body region exist, and may be accepted if appropriately justified, a recommended dataset of metrics for the simulation outcomes is provided below:

- Head injury risk
 - 15 ms Head Injury Criteria (HIC₁₅)
- Chest injury risk
 - Rib deflection distance
- Run-over risk
 - Proportion of collisions with a minimum clearance of <0.5 m, at any point in time during the collision, between the trajectory of the bus front end structures and VRU centre of gravity

Further detail on the average injury risk metrics across all five test positions and three different impact speeds for current best-in-class bus designs, as determined through simulations performed by TRL on behalf of TfL, may be found below in Table 39_2. These values may be used as comparators to assess the relative VRU safety performance of the subject vehicle, but should always be placed in the context of the range of VRU surrogate models and boundary conditions investigated by the specific evidence pack provided by the OEMs.

Table 39_2: Average injury risk metrics for HIC₁₅ and lateral rib deflection injury metrics and proportion of run-over events across all five test positions for collisions at three representative impact speeds

Vehicle Speed	HIC ₁₅	Lateral Rib Deflection (mm)	Run Over Risk (m)
10mph	21.5	13.5	0%
20mph	254.6	25.6	20%
30mph	739.7	37.3	60%

Alternatively, the subject vehicle may be directly compared to an earlier vehicle design from the OEMs (ensuring that this earlier design was the latest variant that was type approved before 2019). For this analysis an overall improvement in



outcome must be shown with the subject vehicle when directly compared to the earlier vehicle design, with outcomes and criteria for both buses following the approaches defined in these sections. Both buses would be expected to be appropriately modelled and validated.



4 Example Simulation Matrix

As specified in the previous sections, the responsibility lies with the OEMs for deriving a simulation matrix to assure the Test Service that the changes in bus front end design results in an overall improvement in VRU safety and that any unintended consequences for a particular collision scenario have been mitigated.

Such a simulation matrix should include consideration of the following elements:

- VRU type
- VRU size
- VRU impact position
- VRU speed
- VRU gait
- Bus speeds

An example of such a matrix is shown below in Table 39_3, however, it is expected that OEMs propose their own matrices to prove overall improvements in injury and no unintended consequences to the Test Service.

Table 39_3: Indicative simulation matrix

#	Size	Impact Position	VRU activity	Struck-side leg position	Bus speed
1	Adult male (50 th percentile)	P1	Walking	Forward	20 mph
2	Adult male (50 th percentile)	P2	Walking	Forward	20 mph
3	Adult male (50 th percentile)	P3	Walking	Forward	20 mph
4	Adult male (50 th percentile)	P4	Walking	Forward	20 mph
5	Adult male (50 th percentile)	P5	Walking	Forward	20 mph
6	Adult male (50 th percentile)	P1	Running	Forward	20 mph
7	Adult male (50 th percentile)	P4	Running	Forward	20 mph
8	Adult male (50 th percentile)	P1	Cycling	Forward	20 mph
9	Adult male (50 th percentile)	P3	Cycling	Forward	20 mph
10	Adult male (50 th percentile)	P4	Cycling	Forward	20 mph
11	Adult male (50 th percentile)	P3	Walking	Together	20 mph
12	Adult male (50 th percentile)	P3	Walking	Behind	20 mph
13	Adult male (50 th percentile)	P1	Walking	Together	20 mph
14	Adult male (50 th percentile)	P1	Walking	Behind	20 mph
15	Adult male (50 th percentile)	P3	Walking	Forward	10 mph
16	Adult male (50 th percentile)	P3	Walking	Forward	30 mph
17	Adult male (50 th percentile)	P2	Walking	Forward	10 mph
18	Adult male (50 th percentile)	P2	Walking	Forward	30 mph
19	Child (10 years')	P1	Walking	Forward	20 mph
20	Child (10 years')	P3	Walking	Forward	20 mph
21	Child (10 years')	P4	Walking	Forward	20 mph



Attachment 40: Bus Front End Design

– Enhanced Geometric Requirements

Guidance Notes

(Vulnerable Road User (VRU) Frontal Crashworthiness)

1 Introduction

Bus fronts have been identified as one of the key injury-causing contact areas of the vehicle in collisions between buses and Vulnerable Road Users (VRU). Therefore, all bus front ends are required to have a global geometric design that both improves protection for VRUs during the primary impact of a collision and reduce the risks of VRUs being run over subsequently.

As such, all new buses shall have a front end design that complies with the Vulnerable Road User (VRU) crashworthiness enhanced bus front end geometry requirements for both vertical rake and horizontal curvature.

This document sets out the guidance notes related to the assessment of the global bus front end geometry and specifically, with respect to the enhanced requirements contained in Section 4.6.2 and Attachment 39 of the Bus Vehicle Specification. These guidance notes are aimed at bus operators and OEMs as a practical guide for implementation of the requirements as specified by the Bus Vehicle Specification.

These notes are for guidance only, and are not legally binding. In all circumstances, the guidance provided by a OEMs of the bus or system shall take precedence, and these guidance notes are only for use in the absence of other information. These are not intended to be exhaustive, but to point the operators toward practical advice and questions to raise with OEMs/suppliers.

2 Selection of buses/systems

From 2024, all new buses shall have a front end geometry that complies with the enhanced bus front end geometry requirements for both vertical rake angle and horizontal curvature. Therefore, selection can be any bus that is compliant with these specifications.

2.1 Intention of the requirements

The enhanced bus front end geometry requirements intend to mandate bus front end designs that implement a progressively curved (in the horizontal plane) and raked (i.e. vertically angled) design.

It was observed, in research performed by TRL that impacts against curved and raked bus front ends improved VRU injury and run over risks relative to traditional



flat-fronted designs. This benefit was, however, limited to a particular optimised design envelope, with this enhanced bus front end geometry envelope found to considerably improve risks relative to current bus front end designs (i.e. larger/smaller vertical rake angles and shallower/deeper horizontal curvatures therefore did not improve VRU injury and run over risks).

It was also found within this research that the geometric design of bus front ends could be further optimised within the enhanced bus front end geometry envelope. This would provide additional casualty saving benefits, beyond that of bus front end geometries at the boundaries of the design envelope. This relationship is, however, highly complex and non-linear due to the many interactions between the various variables involved in such collisions. To this end, these requirements also specify the use of a bus front end geometry performance evaluation tool to provide guidance to users on the relative safety performance level of their designs.

Due to the complex nature of the interactions between variables for these collisions, these requirements also provide OEMs with an alternate compliance pathway. This permits OEMs to evidence improvements in the safety performance of the bus front end through a simulation-based approach, rather than by demonstrating compliance with the enhanced bus front end geometry envelope. OEMs are required to prepare a dossier of evidence that ensures that their simulations are of an appropriate quality and that they demonstrate improvements in safety across a range of expected VRU collision scenarios.

These requirements therefore seek to mandate the design of bus front end geometries for new buses into the TfL network to improve VRU injury and run-over risks relative to current designs. These requirements also seek to promote the design of new bus front ends that optimise the interaction of the VRU with the bus to further reduce the overall risks of injury and run-over.

2.2 Interpreting the requirements and selecting the most effective way to fulfil them

To achieve compliance with these enhanced bus front end geometry requirements, changes in bus lengths or capacity, driven by the raking and curvature of the bus front end, may be expected. Extended bus front end lengths or an increase in the rearward sweep of the bus front end may either be adopted to meet these design requirements, with both approaches needing to consider the impact they would have on operations. The extension of the front end may be expected to impact the turning circle, approach angle, ramp angle and stabling capacity of the bus, whilst an increase in the rearward sweep could impact door positioning, available passenger capacity and accessibility.

Information should therefore be sought by operators to understand the impact that the design approach adopted by the OEMs would have on operational constraints. This said, the enhanced bus front end geometry envelope requirements permit a range of vertical rake and horizontal curvature for selection. The minimum impact this design envelope should have on bus front end lengths is an extension of circa 300 mm at the longitudinal centreline of the bus, with similar distances rearward at the edges of the bus should there be no length extension.

The enhanced requirements are intended to dictate a progressive surface geometry for the bus front end to bring about improvements in vulnerable road user protection.



It is expected that the surface is broadly continuous in this regard. However, it is also recognised that necessary features are incorporated in the bus front end for functional reasons and styling. Experience from the car industry suggests that small projections and protrusions can be used to provide localised areas of angled surfaces. The most effective vulnerable road user protection will be realised if the geometry requirements are adopted generally, the greater the size of the areas presenting that angle then the more effective the measure will be.

2.3 Compliance and warranty

The enhanced geometry requirements may be assessed against a new build bus. It is expected that existing designs will not be fully compliant. Therefore new build buses will be required before full compliance with these requirements can be demonstrated.

Bus operators should ask to see documentary evidence of compliance with these requirements. Compliance may be established through either a CAD-based approach or physical testing. Whichever approach is adopted, a dossier of inspection points and measurements should be provided to assure compliance.

2.4 Features sharing other functional requirements

It is important to ensure that the front end of a bus performs well in other crash and failure modes, such as with other buses, HGVs and cars. This would require stiffer structural members within the broad VRU contact area. It is advised that protection in these other modes is considered at the same time as implementing design changes aimed at protecting VRUs. This is needed to deliver protection to both the bus drivers, other road users and VRUs.

One option is to use UN Regulation 29 (with regard to the protection of cab occupants of a commercial vehicle), and this has already been used by some OEMs. The geometry of category M3 buses is quite different to other vehicles, so the geometric and structural interactions with other vehicles must be carefully considered, and other tests may also be relevant. TfL is not yet making any requirements on this topic, but is recommending any new bus designs consider the interactions with a wide range of collision partners. For iterative, evolving designs this is unlikely to present a problem, but for those bus fronts designed with a substantially different front end geometry, then additional care should be taken over preserving safety for the driver and for ensuring crash compatibility for collisions with other road users.

3 Training

3.1 For test houses

The nature of verifying compliance with the requirements will depend on whether it is demonstrated through CAD or physical testing.

For CAD assessments, appropriate sections should be cut to demonstrate bus front end geometry in a way that can be visualised against the requirements. Any



inspection should be facilitated by applying tangents to the surface at the test point where the appropriate angles of vertical rake or horizontal curvature can be viewed.

For physical inspections, the vertical rake can be measured with an inclinometer, while the horizontal angle can be measured through a protractor arrangement that may be used to determine the horizontal angle relative to the frontal plane of the bus. Here it should be noted that the footprint for the measurements should be $236 \pm 5 \text{ mm} \times 236 \pm 5 \text{ mm}$. This is to ensure that only the global geometric features of the bus are considered by these requirements and that smaller features are considered to not have a significant effect on the outcomes of VRU collisions.

Test houses undertaking approval tests to UN Regulation No. 127 or UN Regulation GTR No. 9 will already possess the capability to apply a 236 mm x 236 mm probe to the front of a car in order to determine the bumper corners.

4 Ongoing observations

4.1 Glare and visual artefacts

In discussions around these geometric requirements, two issues have been raised as potential disbenefits associated with the improvements for VRUs protection. These are:

1. That the vertical rake of the windscreen may refract light from overhead sources (such as street lights and the sun) creating glare for the driver.
2. That the horizontal curvature of the windscreen may create apparitions or visual artefacts that distort direct vision for the driver, particularly towards the corners of the screen.

As these enhanced requirements will take the design envelopes for bus front end geometries beyond that of existing designs, it is feasible that these new designs may be susceptible to these issues. Therefore, operators should be mindful of the potential and will be expected to log and feedback any potential issues, if substantiated reports become available.



Attachment 41: Bus Front End Design

– Wiper Protection Guidance Notes

(Vulnerable Road User (VRU) Frontal Crashworthiness)

1 Introduction

Bus fronts have been identified as one of the key contact causing parts of the vehicle in collisions with Vulnerable Road Users (VRU). Therefore, all bus front ends, in the region of potential head contacts, are required to have a construction that absorbs energy and protects VRUs in the event of a contact at that location on the vehicle.

As such, all buses shall have their VRU impact testing performance assessed against the associated VRU impact testing protocol. All buses shall have front ends which are energy absorbing or sufficiently compliant or frangible to meet the performance requirements.

This document sets out the guidance notes related to the assessment of VRU Impact Performance in the specific aspect of windscreen wipers. These guidance notes are aimed at bus operators and OEMs as a practical guide for implementation of the Bus Safety Standard.

These notes are for guidance only, and are not legally binding. In all circumstances, the guidance provided by an OEM of the bus or system shall take precedence, and these guidance notes are only for use in the absence of other information. These are not intended to be exhaustive, but to point the operators toward practical advice and questions to raise with OEMs/suppliers.

2 Selection of buses/systems

Any bus that meets the TfL Bus Vehicle Specification.

The windscreen wiper requirements may be assessed against a new build bus.

2.1 Compliance and warranty

A bus operator should ask to see one of two things from the OEM.

- a) A statement confirming that the windscreen wipers are mounted at a height greater than 2.0 m from the ground plane – making them exempt from impact testing
- b) If mounted at or below 2.0 m, a VRU Impact Performance test report confirming that when impacted at the worst case location, the head injury criterion (HIC₁₅) value did not exceed [1,300]



2.2 Interpreting the requirements and selecting the most effective way to fulfil them

The most effective way of controlling head injury risk through potential contacts with the windscreen wipers is to move the mounting points out of the likely regions of the bus front end that may be contacted in a collision. Citing them above 2.0 m fulfils this requirement for most of the vulnerable road user population.

Another method of mitigating injury risk is to make the structures compliant, frangible or shielded by a protective element. The extent to which this has been achieved can be assessed practically through the impact test protocol. Assuming that the windscreen wiper is no more injurious than the surrounding region of the bus front end, then this secondary approach may be considered as an appropriate alternative to repositioning the wiper mounting points.

2.3 Direct vision

If the windscreen wiper mounting points have been altered between bus design iterations, then care must be taken to ensure that the swept area of the windscreen is at least maintained. This must still be compliant with direct vision requirements.

2.4 Indirect vision

The nearside mirror of a bus may be visible to the driver though the swept area of the windscreen. If this is the design philosophy adopted by an OEM, then this requirement should be preserved.

3 Training

3.1 For test houses

Test houses accredited to undertake approval tests to UN Regulation No. 127 or UN Regulation GTR No. 9 will be considered suitable to undertake performance tests. Test houses without such accreditation will be required to demonstrate to TfL at their expense that they can achieve the same standard of testing as an accredited organisation.

3.2 Bus maintenance engineers

The engineers carrying out general bus maintenance should be aware that access to the windscreen wipers may be more difficult with them mounted at more than 2.0 m from the ground. This is considered to be a minor effect.



Intentionally Blank