



LONDON BUS SERVICES LIMITED

Specification for new buses: Attachments

Version 2.0

Issued March 2020

Effective from Tranche 730



1 Preface

This protocol covers the assessments to be carried out for safety features fitted to Transport for London (TfL) buses.

Where an Original Equipment Manufacturer (OEM) perceives that a particular feature should be changed, this should be raised by the OEM with the competent authority (TfL) assessor present at the assessment, or in writing to the competent authority (TfL) Nominated Officer in the absence of an assessor. The competent authority (TfL) will assess the problem based on their judgment and provide instruction to the relevant Test Service/s.

OEMs are barred from directly or indirectly interfering with the assessment and prohibited from altering any characteristics that may impact the assessment, including but not restricted to vehicle setting, laboratory environment, etc.

2 Disclaimer & Copyright

TfL has taken all appropriate caution to guarantee that the information contained in this protocol is correct and demonstrates the prevailing technical decisions taken by the organisation. In the occasion that a mistake or inaccuracy is identified, TfL retains the right to make amendments and decide on the assessment and future outcome of the affected requirement(s).

©Copyright TfL 2020: This work is the intellectual property of TfL. A licence is permitted for this material to be distributed for non-commercial and educational use on condition that this copyright statement shows on the replicated materials and information is provided that the copying is by permission of TfL. To circulate otherwise or to republish will be deemed a breach of intellectual property rights.

Some sections of text in the attachments are reproduced with permission from Euro NCAP.



Table of Contents

Attachment 1: London Bus Cycle	5
Attachment 2: Noise Test Procedure and Limit Values	12
Attachment 3: Fleet Management Systems (FMS)	20
Attachment 4: Installation Specification for Fleet Management Systems (FMS)	21
Attachment 5: TfL Approved Bus Layouts	24
Attachment 6: Standard for the Fire Retardant Properties of Materials	25
Attachment 7: Wheelchair Floor Logo	27
Attachment 8: Staircase Handrail Layout	30
Attachment 9: Heating Ventilation and Air Conditioning (HVAC)	32
Attachment 10: Destination Display Output	38
Attachment 11: CCTV	39
Attachment 12: Exterior and Interior Notices	40
Attachment 13: Operator Codes and Fleet Number Identification.....	41
Attachment 14: Free Issued Equipment	42
Attachment 15: Advanced Emergency Braking (AEB) Assessment Protocol	43
Attachment 16: Advanced Emergency Braking (AEB) Guidance Notes	75
Attachment 17: Intelligent Speed Assistance (ISA) Assessment Protocol.....	80
Attachment 18: Intelligent Speed Assistance (ISA) Guidance Notes	101
Attachment 19: Bus Vision Standard Assessment Protocol	104
Attachment 20: Bus Vision Standard Guidance Notes	131
Attachment 21: Blind Spot Mirrors Guidance Notes	136
Attachment 22: Camera Monitor Systems (CMS) Guidance Notes	138
Attachment 23: Rear view Camera Monitor Systems (CMS) Guidance Notes.....	141
Attachment 24: Blind Spot Warning (BSW) Assessment Protocol	144
Attachment 25: Blind Spot Warning Guidance Notes	188
Attachment 26: Pedal Application Error Assessment Protocol.....	194
Attachment 27: Pedal Application Error Guidance Notes	205
Attachment 28: Runaway Bus Prevention Assessment Protocol	211
Attachment 29: Runaway Bus Prevention Guidance Notes	220
Attachment 30: Acoustic Conspicuity Assessment Protocol	223
Attachment 31: Acoustic Conspicuity Guidance Notes.....	229
Attachment 32: Slip Prevention Assessment Protocol.....	231
Attachment 33: Slip Prevention Guidance Notes	236
Attachment 34: Occupant Friendly Interiors Assessment Protocol	241



Attachment 35: Occupant Friendly Interiors Guidance Notes262

Attachment 36: Bus Impact Test Standard Assessment Protocol.....266

Attachment 37: Bus Impact Test Standard Guidance Notes285

Attachment 38: Bus Front End Design – Minimum Geometric Requirements
Guidance Notes.....290

Attachment 39: Bus Front End Geometry Test and Assessment Protocol293

Attachment 40: Bus Front End Design – Enhanced Geometric Requirements
Guidance Notes.....310

Attachment 41: Bus Front End Design – Wiper Protection Guidance Notes314



Attachment 1: London Bus Cycle

1 Introduction

The LBC supersedes the former Transport for London MLTB procedure and encompasses a number of additions to more accurately reflect real-world driving conditions. TfL in conjunction with the LowCVP have harmonised both the former MLTB and LUB cycles, enhanced test procedures & setup conditions so that the real-world operating conditions are better reflected during the test process. This has enabled LowCVP and TfL to combine both test cycles into one bus test cycle called the “UK Bus Cycle” or UKBC.

The following preconditions, vehicle setup, in-test procedures and emission standards must be met in order for a TfL designated testing service to issue LBC certification.

2 Normative References

The following normative documents, in whole or in part, are referenced in this document and are indispensable for the correct application of this test and assessment protocol. For dated references, only the edition cited applies. For undated references, the latest edition of the referenced document (including any amendments) applies.

- United Nations Economic Commission for Europe (UNECE) Regulation 101: Uniform provisions concerning the approval of passenger cars powered by an internal combustion engine only, or powered by a hybrid electric power train with regard to the measurement of the emission of carbon dioxide and fuel consumption and/or the measurement of electric energy consumption and electric range, and of categories M1 and N1 vehicles powered by an electric power train only with regard to the measurement of electric energy consumption and electric range.

3 Definitions

For the purpose of this Protocol:

- **Test Service:** The test service is an organisation designated by TfL to ensure comparative standards and quality of testing is achieved. Only an accredited testing service can be used, a list of approved authorities is available on request to TfL
- **Test Bus:** is the vehicle being assessed for its emissions performance
- **ULW:** Unladen weight of the bus when all fluid levels are filled to recommended levels but no driver, passengers or luggage are on board.
- **GVW:** Gross Vehicle Weight is the maximum weight of the vehicle permitted by law or defined by the OEM, whichever is the lower.



- **Payload capacity:** is the GVW minus the ULW.
- **Test weight:** Is the total mass of the vehicle at which testing shall be undertaken and is equal to the ULW plus the passenger load
- **Passenger load:** The passenger load is a mass equal to the number of passengers multiplied by 68 kg plus 75kg to represent the driver.
- **ECU:** Electronic Control Unit
- **OEM: Original Equipment Manufacturer** – The company responsible for the manufacture of a completed bus, delivered to a bus operator

4 Vehicle Preparation

Testing shall in principle follow UNECE Regulation 101, whole vehicle testing procedure for passenger cars.

The Test Bus shall be provided either by the OEM or by TfL. It shall be specified in accordance with the full applicable requirements of the London bus specification.

The testing service should request a vehicle specification sheet detailing the bus model, registration plate, ULW, GVW, passenger capacity: both seated and standing, engine start process).

OEMs and / or bus operators are permitted to be present during preparation and testing but are not permitted to interfere with or adjust the bus engine calibration/ after treatment/ propulsion / energy recovery system without full agreement of the testing service and TfL. A software ID and serial number will be noted by the test service and recorded on the test certificate issued. Any adjustments will be noted by the testing service. Laptops must not be connected during certification runs. ECU flash file must be as used in London operation. Certification runs must be in the same condition and consecutive.

The test bus shall be weighed by the testing service to obtain the ULW and compared to the ULW as certified on the side of the bus. The ULW as measured by the testing service shall be used for the purposes of the test.

The test Vehicle shall be loaded with a ballast mass equivalent to the passenger load, which shall be calculated as follows:

- a) If the seated passenger capacity multiplied by 68 kg per passenger is a mass of half of the payload capacity or more, then the passenger load shall be defined based a passenger number equal to half of the seated capacity.
- b) If the seated passenger capacity multiplied by 68 kg per passenger is a mass of less than half of the payload capacity, then the passenger load shall be defined based a passenger number equal to a quarter of the total passenger capacity (seated + standing).

Wheels and tyres shall meet the OEMs specifications. Tyre pressures shall be set to the OEM's recommendation and shall be the same for both track coastdown and dyno tests.

The exhaust system shall be checked to ensure it is free from significant leaks. The wheels and tyres used for track coastdown must be to OEM specification. Track coastdown and dyno tyre pressure must be the same.



If a coastdown is required, the test bus must be delivered to the Test service ahead of the scheduled test date.

The Test Bus must be in a safe on-road condition for testing. No warning lights shall be present on instrument panel (except if present due to a modification to allow vehicle to drive on a chassis dynamometer) and power steering **MUST** be active.

5 Test Procedure & Limit Values

5.1 All Buses

The bus is linked to a chassis dynamometer in a test chamber for emissions testing. The test chamber is held at a temperature of 10°C +/-2°C and vehicle tracking fans are positioned to simulate actual road speed in the test chamber.

All power operated passenger doors shall be opened and closed on every designated bus stop, except during a warmup phase. Doors shall not be opened at any other time during the test.

All bus ancillaries must be turned on including; all interior lighting, exterior sidelights and dipped beam headlamps.

Drivers cab demisters shall be turned on to full.

50% of available opening saloon windows shall be open on upper & lower saloon, evenly distributed and every other window each side.

Interior heating shall be set at 17°C ± 2° C (if not automatically controlled) for diesel & diesel-electric hybrid vehicles, 15°C for battery & fuel cell electric vehicles with a ± 1° C variation during test permitted. Heating shall be switched on at the start of the warm up phase of the test procedure. Doors shall remain closed throughout the warm up phase.

The Test service shall monitor the temperature in the centre aisle. The combined average saloon temperature per test run shall be recorded on the test certificate. The positions at which temperatures shall be monitored are defined as:

- a) Lower Saloon, 1m above the saloon floor
- b) Centre front of bus (0.5m from windscreen)
- c) Centre of middle aisle
- d) Centre rear (0.5m from back of bus)
- e) Next to front windscreen demister vent

Upper Saloon, 1m above saloon floor:

- a) Centre front of bus (0.5m from windscreen)
- b) Centre of middle aisle
- c) Centre rear (0.5m from back of bus)

None of the above temperature readings should fall outside of the permitted range at any time. Temperature variation outside of permitted limits may result in a failed test, subject to review by TfL.



5.2 Conventional Diesel and Diesel Electric Hybrid Buses

The UKBC is made up of the following phases based on the original LUB and MLTB cycles but in a revised order.

- a) Outer Urban Phase
- b) Inner Urban Phase
- c) Rural Phase

The Precertification warm up run shall use only the Outer Urban Phase.

Note: In the previous LBSL emission procedure, warm-ups used the full MLTB cycle.

The data from all three phases from the new UKBC is combined to give an average emission performance and is used for certification by LowCVP.

Data from the LBC, i.e. the Outer Urban and Inner Urban phases, is combined to give an average emission performance and is used for certification by TfL. This must be extracted from a full UKBC run. To reflect the changes in procedure and harmonisation with LowCVP into a single UK bus test the Outer and Inner Urban phases extract from UKBC will called London Bus Cycle, LBC.

To clarify:

- a) UKBC = Outer + Inner + rural phases
- b) LBC = Outer and Inner phases (Previously MLTB)
- c) The LBC shall not be tested in isolation. It must be extracted from a full UKBC test. The rural phase of tests must be carried out on every vehicle
- d) Pre-test cycle warmup shall be an Outer Urban Phase, and shall be performed prior to each test run

The buses must arrive at the test site with a full tank of fuel, including Ad-Blue. A one litre fuel sample shall be taken and retained for analysis if required.

Well-to-wheel emissions factors will be taken from the most recently published UK Government's (currently DBEIS) annual average carbon conversion factors for UK fuels e.g. Pump diesel inclusive of biofuel content.

The bus will be run over three validated UKBC cycles of the above test to produce an average result in the report from the extracted Outer and Inner Urban phases (LBC). Cycles must be consecutive unless net energy change (NEC) exceeds +/- 5% in which case another test shall be required.

NEC shall be calculated as per the revised LBC procedure, document available on request to TfL.

Bag analysis of the following emissions is reported for each test. Emissions are reported on each of the three phases (outer, inner, rural) and a combined overall test average, in grammes per kilometre for each pollutant.

- a) Engine NO_x, NO, NO₂, HC, CO, CO₂ at 1 Hz
- b) Tailpipe NO_x, NO, NO₂, HC, CO, CO₂ at 1 Hz
- c) FTIR at tailpipe (NO, NO₂, N₂O, methane (CH₄), NH₃)
- d) Particle number to PMP method



- e) Three dilute ‘bags’ collected and analysed for NO_x, CO, HC & CO₂
- f) PM is measured over the combined Outer and Inner urban phases on one filter, per test cycle. The Rural phase shall be collected on a single filter, per test cycle. The weighted average mass of the Outer/Inner and the Rural phase shall be calculated for the UKBC
- g) Fuel Consumption is calculated using Carbon Balance Method, reported in Litres / 100km

An emission test summary sheet showing all ‘bag’ data shall be provided to TfL showing all ‘legislated’ pollutants along with a TfL emissions summary certificate indicating CO_{2e}.

A “hybrid” bus is defined as a bus that has on board energy storage which is then used to provide vehicle traction.

For hybrid buses that have the ability to operate in electric mode for more than 1km, the effect of the transition from electric to diesel on SCR efficiency will need to be demonstrated. For these vehicles, the test procedure must be agreed with TfL in advance of testing being conducted.

The emissions measured on average over the extracted LBC, shall not exceed the limit values defined below:

Emission	Double Deck		Single Deck	
	Standard Diesel	Hybrid Diesel-Electric	Standard Diesel	Hybrid Diesel-Electric
CO ₂ g/Km	1250	980	900	750
NO _x g/Km	0.5			
PM g/Km	0.01			
PN/Km	6E+11			
CO _{2-e} g/Km	<5% CO _{2-Tot}			
NH ₃	10ppm (average) 25 ppm (peak)			

TfL reserves the right to review emissions test limits at anytime, however limits are not subject to an annualised update on publication of DBEIS annual UK average carbon conversion factors.

5.3 Battery Electric Buses

Buses powered by battery electrical energy storage shall be tested over the complete UKBC procedure. It shall be assumed that they are charged using average UK grid-sourced electricity.

Energy consumption over the LBC will be extracted from the full UKBC via the use of current clamps connected to the high voltage (HV) battery.



The vehicle shall be driven over a minimum of 4 consecutive repeats of the UKBC with minimal breaks between the cycles. No prior warm up cycle before test run is required (A short warm up may be performed by the test house, at their discretion).

As no warm-up run is required, the saloon temperature limit of $15 \pm 1^{\circ}\text{C}$ will not apply to the first test of the four consecutive test runs of a battery EV. The correct saloon temperature shall be achieved on all other subsequent runs.

The vehicle shall be fully charged in a set location, less than 500m from the chassis dynamometer. The vehicle should be electrically fully charged using the OEMs recommended equipment and process. OEMs must liaise with the test house to ensure the correct charging equipment is provided for vehicle charging.

If necessary the vehicle shall be moved to the test cell by driving or otherwise, but aiming to use as little energy as possible. This is to save potential costs for facility utilisation whilst charging.

The testing shall commence as soon as possible after the vehicle is removed from charge and within 6 hours as a maximum.

For the purpose of creating a dynamometer set of coefficients, the test house is allowed to use the dynamometer to motor the driven axle up and then allow it to coastdown as controlled by the dynamometer. Otherwise rotation of the wheels should be kept to a minimum.

The distance travelled shall be recorded by the dynamometer. If the vehicle warns the driver to stop and recharge or cannot achieve 20km/h then the test shall be aborted.

The OEM will provide the ability for the test house to read the traction battery State Of Charge (SOC). This will be recorded by the test house at the start and end of each phase of the LBC.

The OEM shall declare the minimum SOC that the vehicle will operate normally at, as well as the maximum available on-board energy that can be used for vehicle operation in kWh.

The vehicle shall be moved, if required, using minimal energy, to be recharged using the same equipment prior to testing not more than 1 hour after the completion of the 4th cycle.

The vehicle shall be fully recharged during which the energy drawn from the mains by the charger shall be measured on a continuous basis as required in Regulation 101, and recorded.

The energy consumption shall be calculated as the total energy consumed by the mains charger (including energy lost during charge process) divided by the recorded distance travelled over the 4 UKBC tests. This shall be expressed as kWh/km.

The overall vehicle emissions factors in g/km will be derived using the consumption calculated in item 37 above in kWh/km and the national grid average emissions as stated by the latest UK Government National averages for UK Grid electricity, as stated in point 21.

From the SOC and distance travelled data this shall be linearly extrapolated to equate to an estimated range distance based on the declared minimum SOC recommended in service to maintain battery warranty.



5.4 Plug-in & Opportunity Charging Hybrid Buses

OEMs should discuss the operating characteristic for their plug-in vehicles with TfL and the test house to ensure the optimum test process is adopted.

Please contact TfL directly if you have a technology not considered here or wish to gain further clarity on the test process detail.

5.5 Fuel Cell Buses

The evaluation process is currently under development.



Attachment 2: Noise Test Procedure and Limit Values

1 Introduction

This procedure is intended to provide objective measurement of both exterior and interior noise associated with the bus

2 Normative References

The following normative documents, in whole or in part, are referenced in this document and are indispensable for the correct application of this test and assessment protocol. For dated references, only the edition cited applies. For undated references, the latest edition of the referenced document (including any amendments) applies.

- ISO 10844:2014 – Acoustics: Specification of test tracks for measuring noise emitted by road vehicles and their tyres.
- IEC 61672-1:2013 – Electroacoustics – Sound level meters – Part 1: Specifications
- IEC 60942:2017 – Electroacoustics - Sound Calibrators
- ISO 362:2007 – measurement of noise emitted by accelerating road vehicles – engineering method – part 1: M and N categories
- United Nations Economic Commission for Europe (UNECE) Regulation 51: Uniform Provisions Concerning the Approval of Motor vehicles having at least 4 wheels with regard to their sound emissions - 03 Series of amendments.
- ANSI S3.5-1969, “Methods for Calculation of the Speech Intelligibility Index”

3 Definitions

- **Sound Intensity** is defined as the power carried by sound waves per unit area in a direction perpendicular to that area. Its standard unit is the watt per square metre. Clearly this is a complex measurement involving multiple units and the range of sound intensity can be very large. Thus, sound intensity is usually measured in Decibels (dB).
- **Decibels (dB)** are effectively a logarithmic ratio of sound intensity relative to a threshold level of 0 dB. Zero dB is the quietest sound audible to a healthy human ear. From there, every increase of 3dB represents a doubling of the sound intensity.
- **Sound pressure level (SPL)** is strongly related to sound intensity and is the difference between ambient air pressure and the peak pressure caused by the sound wave and is measured in units of Pascal. However, sound pressure levels are also often expressed in Decibels. Hearing is directly sensitive to sound pressure.



- **Maximum SPL** is the peak value of SPL recorded during any given measurement period.
- **L_{EQ}** is the Equivalent Sound Level and is defined as the constant sound level that would produce the same cumulative sound intensity as a sound whose level varies over a defined recording period
- **A-weighting**: Sound intensity is spread out across a wide range of frequencies. However, the human ear is not as good at hearing very high or very low frequencies as it is those in the mid range. The standard decibel scale treats all frequencies equally and is referred to variously as flat, linear or Z weighted. An A-weighted decibel scale dB(A) has been developed that weights sound intensities at lower and higher frequencies differently so it more closely represents a human response to sound at relatively low levels.
- **Articulation Index (AI)** is a quantitative measure of the intelligibility of speech; the percentage of speech items correctly perceived and recorded. An articulation index of 100% means that all speech can be understood, 0% means that no speech can be understood.
- **OEM: Original Equipment Manufacturer** – The company responsible for the manufacture of a completed bus, delivered to a bus operator

4 Test Site

The surface of the test track and the dimensions of the test site shall be in accordance with ISO 10844:2014.

The site should allow for free-field propagation of sound, therefore there shall be no obstacles (inclusive of any observers) which could affect the sound field within the vicinity of the microphone.

5 Environmental Conditions

Ambient air temperature must be within a temperature range of 5°C to 40°C.

Wind speed, including gusts, must not exceed 5 ms⁻¹.

6 Instrumentation

Class 1 sound level meters, in accordance with IEC 61672, must be used for exterior and interior measurements.

Calibration of the sound level meters must be done at the start of every measurement session, using a precision sound calibrator (Class 1 or better, in accordance with IEC 60942).

7 Test Vehicle

The test vehicle shall be representative of an in-service vehicle, fitted with all London specific devices, and complete with regards to base vehicle build.

The tyre tread depths shall be a minimum of 1.6 mm and tyre pressures are to be declared by the OEM.



All auxiliary systems must be fully functioning. It is required of the OEM to provide a mechanism to enable the cooling fans to operate at maximum speed.

Any non-conformance must be declared prior to testing, and testing can be continued following the discretion of TfL. It is the OEM's responsibility to ensure that in the event of missing devices, base vehicle components, etc. appropriate ballast is declared.

The peak power engine speed must be declared prior to test.

8 Dynamic tests

8.1 General

Measurement locations shall be as specified in accordance with ISO 362:2007 (as per ECE R51-03).

If a measurement is not able to be completed, then explanation is required.

All sound measurements shall be A-weighted, fast response.

Maximum or LEQ sound pressure levels (SPL) values to be recorded, dependent on test.

A minimum of 4 results to be recorded (within 2 dB).

8.2 Exterior

8.2.1 Vehicles with Internal Combustion Engines

Tests shall be undertaken as defined in UNECE R51-03

When the reference point passes line BB, the test vehicle speed must be 35 ± 5 kmh⁻¹ and with an engine speed between 85 and 89% of the peak power engine speed.

If the test vehicle speed or engine speed is not met from the above point, then consult ECE R51-3 Annex 3 Para. 3.1.2.2.1.2., and conduct further tests as declared.

Between lines AA and BB, stable acceleration shall be ensured.

The tests shall be completed with cooling fans disabled.

The maximum sound pressure level, or arithmetic average as per ECE R51-3 Annex 3 Para. 3.1.3.2. (if further test speeds were required), shall be declared

8.2.2 Vehicles with Hybrid (Parallel and Series) Powertrains

Tests shall be undertaken as defined in section 8.2.1, but separate tests shall be undertaken with internal combustion engines operational and non-operational.

It is expected that the OEM will provide suitable advice or mechanisms to enable full control over the internal combustion engine, else low speed mileage accumulation will be completed to decrease the state of charge of the high-voltage batteries to force the internal combustion engine to operate.



8.2.3 Stationary Vehicle Sound Emissions and Compressed Air Noise

Tests shall be undertaken in accordance with UNECE R51-03 Annex 3 Para. 3.2. and Annex 5.

8.2.4 ECE R51-03 Improved

The tests described in section 8.2 shall be repeated but with cooling fans at maximum operational speed.

8.3 Interior

All interior sound measurements shall be completed at the following microphone positions. The microphone shall be positioned 1.0 m vertically above the seat squab in all cases:

- a) Driver, right-hand ear position.
- b) Forward most seated position, closest to centreline of test vehicle.
- c) Directly above rear axle, closest to centreline of test vehicle.
- d) Rear 5-way, centre seat.

If upper saloon (i.e. double deck bus), then additional measurements at:

- a) Forward-most, closest to centreline of test vehicle.
- b) Rear 5-way, centre seat.

Test conditions and measurements shall be:

- a) Constant speed, 16 kmh-1, HVAC system off: LEQ SPL, 5 second measurements.
- b) Constant speed, 40 kmh-1, HVAC system off: LEQ SPL, 5 second measurements.
- c) Acceleration speed, 16 - 40 kmh-1, HVAC system off: Maximum SPL.

9 Static tests

9.1 General

If a measurement is not able to be completed, then explanation shall be required.

All measurements shall be A-weighted, fast response.

Maximum or LEQ sound pressure levels (SPL) values shall be recorded, dependent on test.

A minimum of 4 results shall be recorded (within 2 dB(A)).

Arithmetic average to be declared.



9.2 Exterior

9.2.1 Door Warning Device(s)

Microphone position shall be 1 m from outermost face of door aperture (away from centreline of test vehicle), bisection across door width, and 1.2 m high.

Maximum SPL shall be declared.

Requirements are applicable to each door.

9.2.2 Ramp Warning Device(s)

Microphone position shall be 1 m from outermost edge of ramp (away from centreline of test vehicle), bisection across ramp width, and 1.2 m high.

Maximum SPL shall be declared.

Applicable to each ramp fitted.

9.3 Interior

Interior measurements for 9.3.3 and 9.3.4 to be completed at the following microphone positions, all are 1.0 m high from seat squab:

- a) Driver, right-hand ear position.
- b) Forward most seated position, closest to centreline of test vehicle.
- c) Directly above rear axle, closest to centreline of test vehicle.
- d) Rear 5-way, centre seat.

If upper saloon (i.e. double deck bus), then additional measurements at:

- a) Forward-most, closest to centreline of test vehicle.
- b) Rear 5-way, centre seat.

9.3.1 Door Warning Device(s)

Microphone position to be 0.5 m from innermost face of door aperture (towards centreline of test vehicle), bisection across door width, and 1.2 m high.

Maximum SPL shall be declared

Requirements are applicable to each door.

9.3.2 Ramp Warning Device(s)

Microphone position to be 0.5 m from outermost edge of ramp (towards centreline of test vehicle), bisection across door width, and 1.2 m high.

Maximum SPL shall be declared.

Applicable to each ramp fitted.

9.3.3 Engine Idle, HVAC system off

The sound pressure level (LEQ) measured over 5 seconds shall be declared



9.3.4 Engine Idle, HVAC system on

Tests shall be undertaken at maximum fan speed.

The sound pressure level (LEQ) measured over 5 seconds shall be declared

10 Articulation Index (AI)

Further analysis shall be done on measured data using ANSI S3.5-1969, "Methods for Calculation of the Speech Intelligibility Index".

Individual AI values to be declared for each measurement location and discrete test.

Average of AI values to be declared.



11 Sound Pressure Level Limits

Table 11-1. Limits for diesel buses.

Single/ Double	Test Element	Limit, dB(A)	AI, %
Both	8.2.1 ECE R51-03 "Motion", Exterior	76/78/80 ¹	N/A
Both	8.2.1 ECE R51-03 "Static", Exterior	N/A	N/A
Both	8.2.3 ECE R51-03 "Compressed Air", Exterior	72	N/A
Both	8.2.4 ECE R51-03 Improved, Exterior	75/77/79 ²	N/A
Single	8.3 Constant Speed, 16 kmh ⁻¹ , HVAC off, Interior	60	
Single	8.3 Constant Speed, 40 kmh ⁻¹ , HVAC off, Interior	67	
Single	8.3. Acceleration, 16 - 40 kmh ⁻¹ , HVAC off, Interior	68	
Double	8.3. Constant Speed, 16 kmh ⁻¹ , HVAC off, Interior	62/65 ³ 52/54 ⁴	
Double	8.3 Constant Speed, 40 kmh ⁻¹ , HVAC off, Interior	69/70 ⁵ 62/62 ⁶	
Double	8.3 Acceleration, 16 - 40 kmh ⁻¹ , HVAC off, Interior	70/72 ⁷ 60/61 ⁸	
Both	9.2.1 Door Warning Device, Exterior		N/A
Both	9.2.2 Ramp Warning Device, Exterior	75	N/A
Both	9.3.11 Door Warning Device, Interior	75	N/A
Both	9.3.22 Ramp Warning Device, Interior		N/A
Both	9.3.3 Engine Idle, HVAC off, Interior		
Both	9.3.4 Engine Idle, HVAC on, Interior		

¹ Dependent on engine power output (in kW).

² Dependent on engine power output (in kW), -1 dB(A) from ECE R51-03 Para. 6.2.2.

³ Lower deck Front/Rear positions.

⁴ Upper deck Front/Rear positions.

⁵ Lower deck Front/Rear positions.

⁶ Upper deck Front/Rear positions.

⁷ Lower deck Front/Rear positions.

⁸ Upper deck Front/Rear positions.

**Table 11-2. Limits for hybrid buses**

Single/ Double	Test Element	Limit, dB(A)	AI, %
Both	8.2.2 ECE R51-03 "Motion", Exterior	76/78/80 ⁹	N/A
Both	8.2.2 ECE R51-03 "Static" , Exterior	N/A	N/A
Both	8.2.3 ECE R51-03 "Compressed Air" , Exterior	72	N/A
Both	8.2.4 ECE R51-03 Improved, Exterior	75/77/79 ¹⁰	N/A
Single	8.3 Constant Speed, 16 kmh ⁻¹ , HVAC off, Interior	59	
Single	8.3 Constant Speed, 40 kmh ⁻¹ , HVAC off, Interior	66	
Single	8.3. Acceleration, 16 - 40 kmh ⁻¹ , HVAC off, Interior	67	
Double	8.3. Constant Speed, 16 kmh ⁻¹ , HVAC off, Interior	62/65 ¹¹ 52/54 ¹²	
Double	8.3 Constant Speed, 40 kmh ⁻¹ , HVAC off, Interior	69/70 ¹³ 62/62 ¹⁴	
Double	8.3 Acceleration, 16 - 40 kmh ⁻¹ , HVAC off, Interior	70/72 ¹⁵ 60/61 ¹⁶	
Both	9.2.1 Door Warning Device, Exterior		N/A
Both	9.2.2 Ramp Warning Device, Exterior	75	N/A
Both	9.3.11 Door Warning Device, Interior	75	N/A
Both	9.3.22 Ramp Warning Device, Interior		N/A
Both	9.3.3 Engine Idle, HVAC off, Interior		
Both	9.3.4 Engine Idle, HVAC on, Interior		

⁹ Dependent on engine power output (in kW).

¹⁰ Dependent on engine power output (in kW), -1 dB(A) from ECE R51-03 Para. 6.2.2.

¹¹ Lower deck Front/Rear positions.

¹² Upper deck Front/Rear positions.

¹³ Lower deck Front/Rear positions.

¹⁴ Upper deck Front/Rear positions.

¹⁵ Lower deck Front/Rear positions.

¹⁶ Upper deck Front/Rear positions.



Attachment 3: Fleet Management Systems (FMS)

(To follow)

Attachment 4: Installation Specification for Fleet Management Systems (FMS)

1 Introduction

This attachment provides requirements relating to the installation of the fleet management systems.

2 Definitions

- **Cable:** this is a generic term used for a wire or lorn and an Ethernet cable.
- **Channel:** a channel is an unrestricted free space through which a cable can be easily drawn. It can be specifically designed for the purpose or make use of the existing design.
- **Fixing,** a point to which a cable can be secured.
- **Roof space,** this is the entire void between the inner and outer roof and coving skins.
- **Void:** an enclosed space.

Note: The terms 'channel' and 'void' largely overlap. Channels will normally make use of voids, but the importance is that a channel will offer an unrestricted cable passage from end to end.

3 General Principles for Cabling Access

Designated cable channels should be provided within the voids between the vehicle body inner and outer skins such that cables can easily be drawn between all equipment compartments and any other part of the vehicle in which equipment may need to be installed.

In particular, there shall be easy cable routes between equipment compartments and the following areas:

- a) Cab dashboard, header panel, offside console and coving, rear bulkhead
- b) Offside and nearside covings, full length of both saloons
- c) Header panels, both saloons
- d) Staircase front, rear and side bulkheads, both saloons, and under stairs area
- e) All power door gear compartments
- f) Front, nearside and rear route/destination display equipment
- g) Engine compartment
- h) Antenna location (forward roof area)



- i) Seat stanchions/grab poles
- j) Any further specific locations to be identified

It shall be possible to feed and draw cables to and between these areas without the need for extensive dismantling of the coachwork, and definitely without the need for any cutting, drilling or other invasive surgery. This shall be achieved by ensuring that all voids/channels are contiguous and can be accessed easily by the provision of appropriate access points.

Access points shall be provided at all junctions and changes of direction.

Where a cable is secured to a fixing point the fixing point must be accessible such that the method used to secure the cable can be easily removed freeing the cable.

Cables for all the operator equipment fitted shall be separate and clearly identifiable.

Cables shall be installed so that when being removed they do not snag existing cables or equipment.

The upper and lower deck coving voids shall have channels on the left and right hand side so that it is possible to freely run cables the full length of the roof. Access shall be provided at regular intervals to facilitate this.

The channels in the roof space in the upper and lower deck shall be connected by channels running across the bus from left to right. These cross bus channels shall be at the front and rear of the bus. Access shall be provided at regular intervals to facilitate the use of these.

There shall be fixing points to fix the cables throughout the length of all channels. The fixing points shall be spaced at distances of approx. 200mm.

It shall be possible to run cables from the equipment enclosure to the lower deck roof space on the left and right hand side. It will be acceptable for the cables to follow the same route to the roof space and then one cable can use the cross bus channelling to access the other side. Access shall be provided at regular intervals to facilitate the use of these.

It shall be possible to run cables from the equipment enclosure to the upper deck roof space on the left and right hand side. If practical the cables may follow the same route to the roof space and then one cable can use the cross bus channelling to access the other side. Access shall be provided at regular intervals to facilitate the use of these.

All access panels used to facilitate the above shall have fastenings designed for the purpose of being removed and refitted by authorised personnel. At other times the panel shall remain securely in position.

All access panel fastenings shall be captive.

In the event access is restricted in areas such as the bodywork to the side of the upper deck front screen and the stairwell, conduit should be provided.

Where conduit is required at the upper deck front screen 2 pieces of conduit shall be provided, one will branch and run towards the front screen the other will run towards the rear of the bus.

Where conduit is required and the path is convoluted with tight bends conduit shall be used in multiple straight lengths.



All cable routes, channels and ducts shall have access points at regular intervals, and at all junctions and changes of direction, to facilitate the insertion and removal of cables.

Where it is not possible to have intermediate access points the minimum bend radius of the conduit shall be as advised by the supplier of the conduit.

All conduit used shall have a smooth internal wall allowing cables to be pushed easily through.

Where conduit is used it shall be a sufficiently long to be accessible at each end to allow easy access

The conduit used shall be a bright colour to allow it to stand out from the conduit used for the bus systems.

If there is a restriction to the dimensions of the conduit due to for instance the body work then the largest dimensions possible shall be used. As an absolute minimum this shall allow an un-terminated Ethernet cable to be drawn through when all cables using the conduit are present.

Where a cable goes through a bulkhead the cable should be secured in such a way that the integrity of the bulkhead is maintained. The method used should allow for additional cables to be fitted.

4 Enclosure Specification

An enclosure with a minimum size of at 50dm³ (1/20 m³) approx. 370mm x 370mm x 370mm shall be provided.

Access to the enclosure shall be provided via secure panels or doors.

The access doors or panels shall be situated to allow ease of access to installation and maintenance personnel.



Attachment 5: TfL Approved Bus Layouts

Attachment 6: Standard for the Fire Retardant Properties of Materials

1 Introduction

This attachment specifies additional standards for materials with respects to their fire retardant capability, over and above those required by Regulation.

2 Normative References

The following normative documents, in whole or in part, are referenced in this document and are indispensable for the correct application of this test and assessment protocol. For dated references, only the edition cited applies. For undated references, the latest edition of the referenced document (including any amendments) applies.

- United Nations Economic Commission for Europe (UNECE) Regulation No 118 Uniform technical prescriptions concerning the burning behaviour and/or the capability to repel fuel or lubricant of materials used in the construction of certain categories of motor vehicles
- BS476: Fire tests on building materials and structures
- UL94: Tests for flammability of plastic materials for parts in devices and appliances
- BS5852: Methods of test for assessment of the ignitability of upholstered seating by smouldering and flaming ignition sources.

3 Requirements

The following schedule of component materials Fire Retardant Standards must be verified by each manufacturer and may be subject to independent assessment during or after submission.

- a) All internal components in the bus that are not specified below must meet the applicable specification in EC Regulations 118.
- b) The current minimum LBSL Materials Fire Retardancy Standards for each type of material used on a vehicle are: -
- c) All materials forming a fire barrier between the engine bay and passenger saloons shall comply with BS476 Class 1, on engine-facing surfaces. This overrides other points below.
- d) All GRP materials utilized as part of the interior or exterior of the bus shall comply with BS476 Class 3 front surface or BS476 Class 2 back surface, as applicable.
- e) Melamine Laminates (side or roof panels) shall comply with BS476 Class 2



- f) All completed flooring (plywood or alternative, including floor covering) shall comply with BS476 Class 2 on upper surface, BS476 Class 3 on lower surface.
- g) Seat frames (ABS or Polycarbonate) shall comply with UL94V0
- h) Seat assemblies shall comply with BS5852 Crib 7
- i) Body Insulation shall comply with BS 476 Class 2
- j) All internal ABS products (capping and finishing trims) shall comply with UL94V0
- k) Body and Floor insulation shall comply with BS476 Class 2

The above materials, or any treatment used to achieve the standard, must be capable of achieving the required standard when suitably cleaned or maintained over the operational life of the bus.

Replacement components and their associated material must achieve the same minimum standard as the original.



Attachment 7: Wheelchair Floor Logo

1. Introduction

This document provides a description of the requirements for Floor Logo to be situated in the demarcated wheelchair area of a bus.

For full understanding of this Attachment it should be read in conjunction with the New Bus Specification, Section 7.

1.1 Scope

These requirements apply to all new buses intended for service under contract to TfL that are passenger vehicles with a maximum mass exceeding 5 tonnes and a capacity exceeding 22 passengers. The passenger vehicles will be capable of carrying seated but unrestrained occupants and standing occupants. Such vehicles are categorised in the Consolidated Resolution on the Construction of Vehicles (R.E.3) as M₃; Class I, Class II.

1.2 Purpose

The purpose of this document is to define the requirements for the Wheelchair Floor Logo.

2. Normative References

The following normative documents, in whole or in part, are referenced in this document and are indispensable for its correct application. For dated references, only the edition cited applies. For undated references, the latest edition of the referenced document (including any amendments) applies.

- London Bus Services Limited New Bus Specification: Section 7
- London Bus Services Limited New Bus Specification: Attachment 33 Slip Prevention Assessment Protocol
- London Bus Services Limited New Bus Specification: Attachment 33 Slip Prevention Guidance Notes

3. Wheelchair area floor covering

The wheelchair logo shall be incorporated into the floor covering which identifies the designated wheelchair area.

4. Dimension requirements

The wheelchair floor logo shall be of identical style to that shown in Figure 7_1 and to the dimensions as shown $\pm 10\%$ as shown in Figure 7_1.

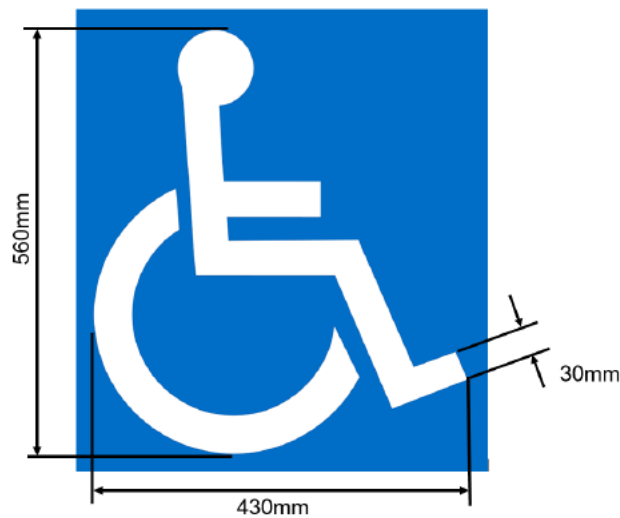

Figure 7_1 Wheelchair Logo

5. Colour requirements

The floor covering used across the whole Wheelchair bay, as shown by manufacturers drawings, shall be coloured in Blue Ref PMS 300 (the same blue as the wheelchair notice). The wheelchair logo shall be coloured in plain White. Mild fleck in the base colours may be added to increase durability of the floor covering.

6. Slip prevention requirement

Material used for the floor logo must conform to the slip prevention assessment protocol and guidance notes found in Attachments 32 and 33 respectively.

7. Location and Orientation requirement

The logo in the wheelchair bay should always be positioned, readable by a person standing on the longitudinal centreline of the vehicle, in such a way to demonstrate the location and orientation which the wheelchair should be positioned. The logo must be located entirely within the bounds of the wheelchair bay, with positional requirements as detailed below:

- The longitudinal (vehicle X axis) centre line of the floor logo should be on the centre line of the vertical wheelchair back board $\pm 55\text{mm}$.
- The lateral (vehicle Y axis) centre line of the floor logo should be no more than 550mm from the wheelchair back board $\pm 55\text{mm}$.

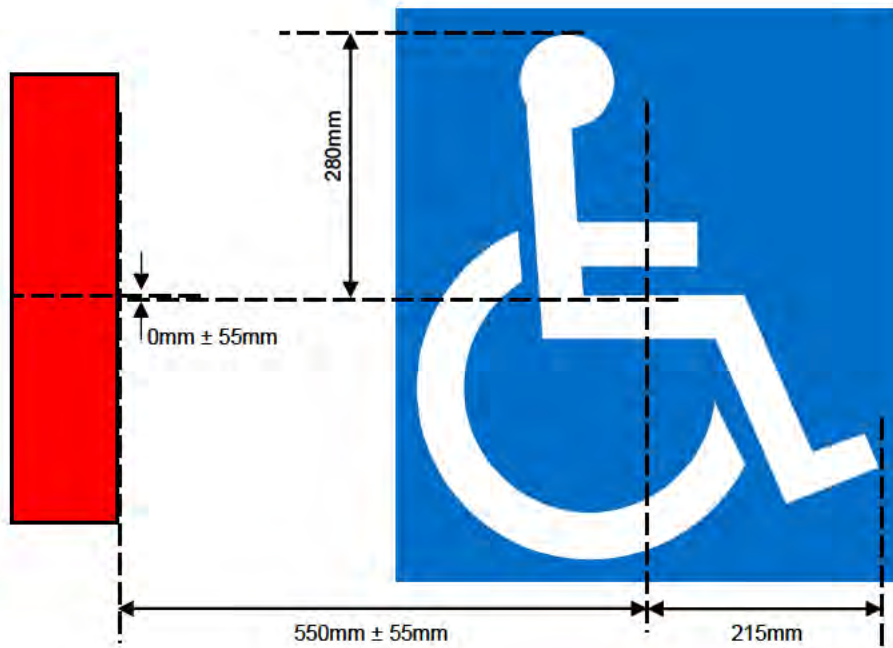

Figure 7_2 Wheelchair logo longitudinal and lateral location relative to back board

Attachment 8: Staircase Handrail Layout

1 Introduction

This document provides a description of the requirements for Handrail layout to be situated by the staircase of a double-deck bus.

1.1 Scope

These requirements apply to all new double-deck buses intended for service under contract to TfL that are passenger vehicles with a maximum mass exceeding 5 tonnes and a capacity exceeding 22 passengers. The passenger vehicles will be capable of carrying seated but unrestrained occupants and standing occupants. Such vehicles are categorised in the Consolidated Resolution on the Construction of Vehicles (R.E.3) as M₃; Class I, Class II.

1.2 Purpose

The purpose of this document is to define the requirements for the Staircase Handrail Layout.

2 Normative References

The following normative documents, in whole or in part, are referenced in this document and are indispensable for its application. For dated references, only the edition cited applies. For undated references, the latest edition of the referenced document (including any amendments) applies.

- London Bus Services Limited New Bus Specification: Section 4.5.1 – 4.5.3

3 Dimension requirements

The size and layout of the staircase and handrail shall be as shown below, Figure 8_1. All positional dimensions given shall be achieved within a tolerance of $[\pm 10]$ mm. (Tolerance applies to position/placement of handrail as shown in Figure only. Any other dimensions, such as handrail diameter, should be separately assessed as appropriate).

A straight hand pole at first joint from top of staircase will also be acceptable.

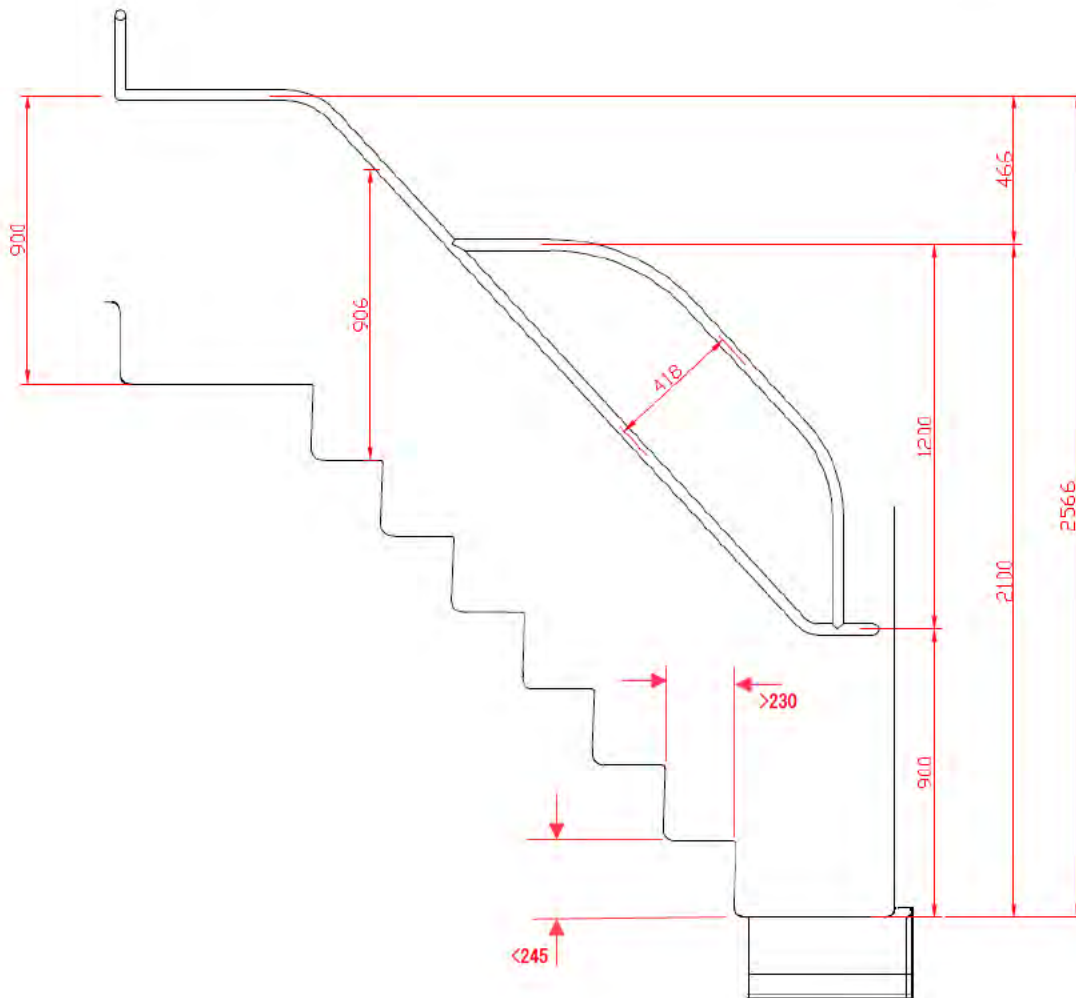

Figure 8_1 Staircase handrail dimensions given in mm

4 Handrail construction and arrangement

- All handrails must be securely fixed to body structure.
- Open joints or butt / sharp ends to rails are not acceptable.
- No potential hand traps shall be permitted.
- Continuous rails are the preferred arrangement.
- Rails must be of a continuous profile throughout.



Attachment 9: Heating Ventilation and Air Conditioning (HVAC)

1 Introduction

This attachment provides specifications, test methods and limit values for the heating ventilation and air conditioning system as required by the main specification document.

The heating and cooling system should keep the bus saloon at a comfortable temperature throughout the day and year. This specification sets out a controlled test; however we expect the heating system to work over a wider range of climate conditions to be capable of maintaining the bus saloon temperature at 15°C evenly throughout the vehicle. Whilst the heating system must be specified to meet the requirements set out in this specification, TfL may choose to set potentially less onerous requirements in service, particularly as we transition to zero tailpipe emission vehicles and range is an issue.

For full understanding of this Attachment it should be read in conjunction with the New Bus Specification, Section 8.3.

2 Scope

This protocol applies to all new buses intended for service under contract to TfL that are passenger vehicles with a maximum mass exceeding 5 tonnes and a capacity exceeding 22 passengers. The passenger vehicles will be capable of carrying seated but unrestrained occupants and standing occupants. Such vehicles are categorised the Consolidated Resolution on the Construction of Vehicles (R.E.3) as M₃; Class I, Class II.

3 Purpose

The objective of this testing is to validate the saloon heating performance of all vehicles and the cooling performance of the upper saloon air cooling systems for double deck vehicles. This test is carried out simultaneously with a test to validate the cooling performance in the driver's cab.

The bus for testing provided either by the OEM or TfL from an operator shall be to the London specification and fitted with all equipment necessary for operation in London.

4 Normative references

The following normative documents, in whole or in part, are referenced in this document and are indispensable for the correct application of this test and assessment protocol. For dated references, only the edition cited applies. For



undated references, the latest edition of the referenced document (including any amendments) applies.

- London Bus Service Limited New Bus Specification Section 8.3

5 Definitions

For the purpose of this Protocol:

- **AA: Approval Authority** – The Approval Authority is the body within TfL that certifies that a bus is approved for use in the TfL fleet and assigns its score under the bus safety standard for use in procurement processes
- **TS: Test Service** – The organisation undertaking the testing and certifying the results to the Approval Authority
- **OEM: Original Equipment Manufacturer** – The company responsible for the manufacture of a completed bus, delivered to a bus operator
- **Test Service:** The organisation undertaking the testing and certifying the results to the Approval Authority.
- **VUT: Vehicle Under Test** - means a vehicle that is being tested to this protocol.

6 Test Conditions

6.1 General Requirements

The Test Service is designated by TfL to ensure comparative standards and quality of testing is achieved.

OEMs and / or bus operator are permitted to be present during testing but are not permitted to interfere with or adjust the bus setting without full agreement of the Test Service and TfL. All adjustments will be noted by the Test Service.

6.2 Instrumentation

The Test Service shall temporarily fit four thermocouples to single deck vehicles or seven to double deck vehicles, three on the lower deck, and three on the upper deck and one in the driver's cab. All thermocouples shall be positioned along the longitudinal centreline of the vehicle.

Thermocouples on the lower deck are to be fitted in the front, middle and rear centre line, 1.2 metres above floor level. The forward / rear position of the four thermocouples should be as follows:

- a) Thermocouple 1 (front) should be located at a position 1.0 m from the front windscreen.
- b) Thermocouple 2 (middle) should be located at the longitudinal centre of the vehicle
- c) Thermocouple 3 (rear) should be located at a position 1.0 m from the rearmost seating row.



- d) Thermocouple 4 will be located 1.2 metres above the floor for the driver's feet, on the centreline of the driver's seat base when the driver's seat is set to a mid-position on its forward / rearward slider.

The upper deck thermocouples will be located 1.2 metres above the floor of the upper saloon, along the longitudinal centreline of the bus (mid-gangway). The forward / rearward position of the three thermocouples should be as follows;

- a) Thermocouple 1 (front) should be located at a position aligning with the middle of the seat base of a seat at the very front of the upper saloon on the nearside.
- b) Thermocouple 2 (middle) should be located at a position aligning with the middle of the seat base of a seat on the 7th row (from front) of the upper saloon on the nearside.
- c) Thermocouple 3 (rear) should be located at a position aligning with the middle of the seat base of a seat at the very back of the upper saloon on the nearside.

The thermocouples are connected to a data logger capable of recording the temperature at each point at a maximum of 1 minute intervals. The results from the data logger shall be the only results utilised to evaluate the test procedure.

7 Heating Test

The heating test is to be undertaken in a climatic chamber with the temperature set at 0°C. In order to simulate the heating effect from passenger loading, 14 x 130 W heaters are to evenly distributed across the front, middle and rear seats (to include upper deck where applicable by applying 7 to the lower deck and 7 to the upper deck).

7.1 Heating (non-zero emission buses)

The heating system shall be capable of raising the temperature from 0°C to 15°C in 45 minutes, rising to and maintaining 17°C within 90 minutes. The test should include both doors opening for 10 seconds at a time to simulate 15 bus stops evenly distributed in the first 25 minutes and 13 evenly distributed in the next 20 minutes. Maximum air vents velocity of 5 m/s.

7.2 Heating (zero emission buses)

Zero emission buses are required to have a pre-heat function. Testing shall follow the timings set out in Figure 9_1 below. The vehicle is to be pre-heated from zero to 15°C (T₂) and maintained at 15°C for 1 hour (T₃). The zero emission bus should maintain a temperature of 15°C whilst doors are cycled (T₄). A ± 1°C degree test tolerance is to be applied to all temperatures. A current clamp will be connected to the HVAC unit to calculate power consumption. The test should include the opening of both doors for 10 seconds every two minutes for one hour. The maximum air vent velocity is 5 m/s.

The testing authority will produce a graph of the test showing the temperature recorded by each individual thermocouple – temperature against time. Ambient chamber temperature will also be included on each graph. A spreadsheet showing



the results from each thermocouple and ambient chamber temperature will accompany the graphs.

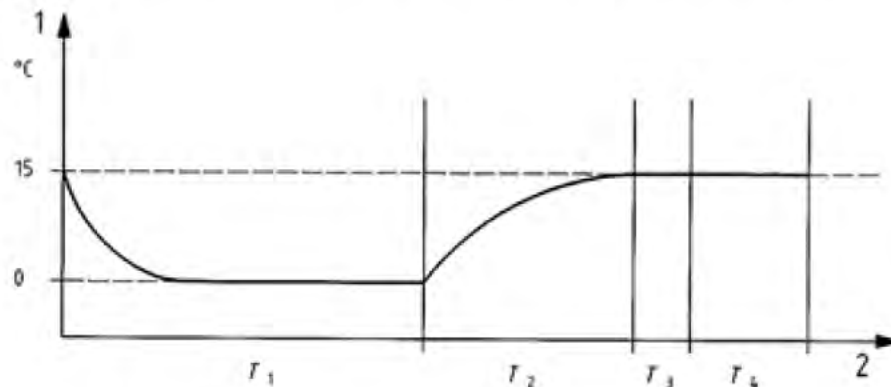

Figure 9_1 – Zero emission bus heating test time profile

Key

1 – Ambient temperature (°C)

2 – Time (T, hr)

T_1 – cooling time, >1hr from the point at which all internal temperatures show 0°C

T_2 – is the heating time

T_3 – is the stabilising time, 1hr from the point at which all internal temperatures show 15°C

T_4 – is the measuring time, 1hr

8 Drivers Cab Air conditioning

8.1 Cab / Drivers Screen Demisting

Control should be by manual driver selection, capable of independent operation at all times and raising the temperature from 0°C to 20°C within 25 minutes. The test should include both doors opening for 10 seconds at a time to simulate 15 bus stops in the first 25 minutes and 13 in the next 20 minutes. The maximum air vent velocity is 5 m/s. For zero emission buses, this test can be undertaken during T_2 in Figure 9_1 above, provided that the internal temperature of the bus is returned to 15°C immediately after the completion of the test, prior to T_3 beginning.

8.2 Drivers Cab Air conditioning

Drivers cab air conditioning must be manual driver selection, capable of independent operation at all times and capable of reducing the temperature from 35°C to 25°C within 25 minutes. Test should include the both doors opening for 10 seconds at a time to simulate 15 bus stops in the first 25 minutes.

9 Upper deck Air Cooling Validation Test



If the drivers cab air conditioning is on, the upper deck air-cooling may function on a reduced setting to balance the cooling system. It must maintain capability of reducing the temperature from 30°C to 25°C within 20 minutes. Test should include both doors opening for 10 seconds at a time to simulate 15 bus stops in the first 25 minutes.

9.1 Air Cooling (Upper Deck Only)

Air cooling should be fully shut down, 'Off' <23°C, 'On' >23°C, gradual build up to maximum capacity output at 28°C. A maximum cooling capacity capable of a reduction of 5°C is required when interior saloon temperature is 30°C over a 30 minute pull down test as described below. If Driver's cab air conditioning is off, upper deck air-cooling will function independently on its automatic temperature settings.

All bus models will be tested in a temperature controlled chamber with an ambient temperature of 30°C and must achieve the pull down procedure shown below to validate settings and efficiencies.

In order to simulate the heating effect from passenger loading, 14 x 130 W heaters are to evenly distributed across the front, middle and rear seats by applying 7 to the lower deck and 7 to the upper deck.

The bus will be put in a closed climate control chamber set at a temperature controlled to hold 30°C ($\pm 1^\circ\text{C}$). It is permissible to open the vehicle windows, doors or roof vents as considered necessary to speed up the soak time.

The soak condition is considered to be met when all three thermocouples record a steady state of 30°C ($\pm 1^\circ\text{C}$) for a duration of 15 minutes after a minimum soak time of 1 hour. A minimum of 15 minutes of data should be recorded to demonstrate a stable soaked temperature. During this time if the temperature of any sensor drops below 30°C ($\pm 1^\circ\text{C}$) the 15 minutes should be reset.

The bus should be powered on when the following preparations checks have been completed:

- a) All windows, roof vents and doors are closed
- b) The thermocouples are correctly positioned
- c) The data recorder is running.

When the bus is switched on the upper saloon air cooling should come on automatically (as above 23°C). The driver's cab air conditioning should be turned on, set to maximum capacity, maximum fan speed and if there is a control to direct the airflow it should be directed to the driver position rather than the windscreen. If possible all dashboard vents, floor vents or ceiling vents in the driver's cab should be directed towards the sensor position as far as practical. If the cab air conditioning has a damper flap to select between fresh air and recirculated air then the recirculated air function should be selected. The drivers windscreen demist system should be turned off and any associated vents closed.

For the complete duration of the test, the bus should be powered on and should be run at the bus engine idle speed, where applicable. If any recirculation air supply is optional or variable the system should be set to maximum fresh air supply. Any demisting or other system that provides air to the upper saloon must be isolated to not interfere with the test results.



The data logger timer should then start.

The test will measure the temperature drop delivered by the system over a 30 minute period on a minute by minute basis.

All three upper saloon thermocouples should achieve the target reduction temperature of 25°C within the first 20 minute period and be capable of holding the temperature below the 25°C for the remaining 10 minutes. Averaging the results is not acceptable over time or between the sensors.

The testing authority will produce a graph of the Pull Down showing the temperature recorded by each individual thermocouple – temperature against time. Ambient chamber temperature will also be included on each graph. A spreadsheet showing the results from each thermocouple and ambient chamber temperature will accompany the graphs.



Attachment 10: Destination Display Output

**Off Side Front
Ultimate Destination**



**1160mm x 330mm
Sight Size**

**Near Side Front
Route Number**



**450mm x 330mm
Sight Size**

Near Side Route Number and Destination

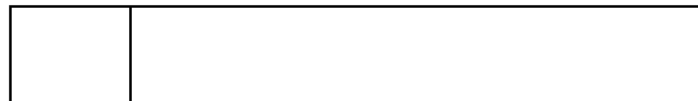

**Route Number Forward
270mm x 210mm
Sight Size**

**Side Destination Rearward
687mm x 210mm
Sight Size**

**Rear
Route Number**

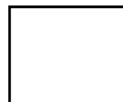

**450mm x 330mm
Sight Size**



Attachment 11: CCTV

(To follow)



Attachment 12: Exterior and Interior Notices

(To follow)

Attachment 13: Operator Codes and Fleet Number Identification

1 Operator Code Requirements

The following operator codes must be used on the roof identification on the first line followed by the operator's fleet number on the second line. The codes must be fitted at the rear of the roof panel in the white panel area as shown in the diagram below

Operator	Code
Abellio	ABL
Arriva	ARL
Go Ahead Group	GAG
CT Plus	CTP
Metroline	MTG
Quality Line	QUL
Stagecoach	STC
London United	LUB
London Sovereign	SOV
Sullivan Buses	SVB
Tower Transit	TTO
University Bus	UNO

Typical Operator Code and Fleet Number Arrangement



Figure 13_1 Rear of Vehicle

- All Characters shall be in New Johnston Bold font
- Characters shall be in Matt Black cut out vinyl
- Characters shall be 350mm in height



Attachment 14: Free Issued Equipment

(To

follow)



Attachment 15: Advanced Emergency Braking (AEB) Assessment Protocol

1 Introduction

Advanced Emergency Braking (AEB) is a system that uses forward looking sensors such as Lidar, Radar, and/or Cameras to identify a risk of an imminent collision.

This document presents an assessment protocol and the underlying test procedures for objectively measuring the performance of Advanced Emergency Braking (AEB).

For full understanding of this Attachment it should be read in conjunction with the Attachment 16: Advanced Emergency Braking (AEB) Guidance Notes and New Bus Specification, Section 4.3.2.

1.1 Scope

This protocol applies to all new buses intended for service under contract to TfL that are passenger vehicles with a maximum mass exceeding 5 tonnes and a capacity exceeding 22 passengers. The passenger vehicles will be capable of carrying seated but unrestrained occupants and standing occupants. Such vehicles are categorised the Consolidated Resolution on the Construction of Vehicles (R.E.3) as M₃; Class I, Class II.

1.2 Purpose

The purpose of the assessment is to test the ability of an AEB system fitted to a bus to avoid or mitigate collisions with other road users while minimising risks to occupants of the bus from unnecessary brake interventions. It is intended that the assessment generates objective data from a controlled and repeatable test to measure casualty reduction potential in the following collision types and where the bus is moving at a speed between 10 and 60 km/h:

- Frontal collisions with the rear of a stationary vehicle ahead
- Frontal collisions with a pedestrian crossing the road
- Frontal collisions with the rear of pedal cycles travelling in the same direction

The assessment also tests for false positive activation in a manoeuvre where the impact can easily be avoided by steering. Premature activation in situations where a pedestrian about to cross on a collision course with the vehicle, suddenly stops before entering the vehicles path is also assessed.

However, it should be noted that tests for true, false and premature positive activations represent only a small proportion of the real-world events that the systems will encounter in service. For example, it is expected that systems will react in collisions with the rear of any normal road vehicle in the lane ahead but only collisions with cars and bicycles are assessed. Similarly, the false and premature activation tests represent just two of thousands of real world scenarios that might



challenge AEB systems. This protocol promotes the functionality that TfL see as reasonably feasible and of most benefit to their objectives but, in isolation, it is insufficient to guarantee excellent system performance at all times in real world service. Manufacturers should always design systems to perform well in real world service and not only to do well in this test.

This test and assessment protocol may be applied in collaboration with a vehicle manufacturer as a validation of data they provide, or independently as part of a market surveillance activity or any other reason as defined by the Approval Authority.

2 Normative references

The following normative documents, in whole or in part, are referenced in this document and are indispensable for its correct application. For dated references, only the edition cited applies. For undated references, the latest edition of the referenced document (including any amendments) applies.

- Directive 2007/46/EC of the European Parliament and of the Council establishing a framework for the approval of motor vehicles and their trailers, and of systems, components and separate technical units intended for such vehicles.
- Regulation (EU) 2018/858 of the European Parliament and of the Council of 30th May 2018 on the approval and market surveillance of motor vehicles and their trailers, and of systems, components and separate technical units intended for such vehicles, amending Regulations (EC) No 715/2007 and (EC) No 595/2009 and repealing Directive 2007/46/EC
- UNECE Regulation 107 Uniform provisions concerning the approval of category M₂ or M₃ vehicles with regard to their general construction
- Euro NCAP Test Protocol AEB VRU Systems Version 2.0.1 August 2017
- Euro NCAP Test Protocol AEB Systems Version 1.1 June 2015
- Euro NCAP Test Protocol AEB Systems Version 2.0.1 November 2017
- Articulated Pedestrian Target Specification document version 1.0.
- Bicyclist Target Specification document version 1.0.
- Euro NCAP Technical Bulletin TB025 – Global Vehicle Target Specification for Euro NCAP
- ISO 15037-2 Road vehicles – Vehicle Dynamics Test Methods – Part 2: General conditions for heavy vehicles and buses



3 Definitions

For the purpose of this Protocol:

- **AEB: Advanced Emergency Braking** – Any system that is active at speeds of 10 km/h or more and uses information from sensors to detect an imminent collision and, if the driver fails to take appropriate avoidance action, automatically applies sufficient braking to avoid the collision or at least reduce the collision speed. Different sub-categories of AEB are currently considered:

AEB bus front to vehicle rear – An AEB system that detects and responds to imminent collisions where the front of the equipped vehicle would collide with the rear of another vehicle directly ahead of it.

AEB Pedestrian – An AEB system that detects and responds to imminent collisions with pedestrians.

AEB Cyclist – An AEB system that detects and responds to imminent collisions with pedal cycles and their riders.

- **Approval Authority:** The Approval Authority is the body within TfL that certifies that a bus is approved for use in the TfL fleet and assigns its score under the bus safety standard for use in procurement processes.
- **FCW: Forward Collision Warning** – An audiovisual warning that is provided automatically by the vehicle in response to the detection of a likely collision to alert the driver.
- **PBC: Peak Braking Coefficient** – The measure of tyre to road surface friction based on the maximum deceleration of a rolling tyre, measured using the American Society for Testing and Materials (ASTM) E1136-10 (2010) standard reference test tyre, in accordance with ASTM Method E 1337-90 (reapproved 1996), at a speed of 64.4km/h, without water delivery.
- **Test Path:** For the bus stop test, the test path is defined by the co-ordinates specified in Appendix A. For all other tests, the test path is a virtual straight-line path equivalent to the centreline of the lane in which the collision occurs.
- **Test Scenario:** An arrangement and movement of vehicles and test equipment that is intended to represent a particular collision type. A range of different test scenarios are referred to in this protocol:

Bus-to-Car Rear Stationary (BCRS) – A collision in which a bus travels forwards towards another stationary vehicle and the frontal structure of the bus strikes the rear structure of the other vehicle.

Bus-to-Pedestrian Farside Adult 50% (BPFA-50) – A test scenario representing a collision in which a bus travels forwards towards an adult pedestrian crossing its path running from the farside and the frontal structure of the bus strikes the pedestrian at 50% of the width of the bus when no braking action is applied.

Bus-to-Pedestrian Nearside Adult 25% (BPNA-25) – A test scenario representing a collision in which a bus travels forwards towards an adult pedestrian crossing its path walking from the nearside and the frontal structure of the bus strikes the pedestrian when it has crossed 25% of the width of the bus when no braking action is applied.



Bus-to-Pedestrian Nearside Adult 75% (BPNA-75) – A test scenario representing a collision in which a bus travels forwards towards an adult pedestrian crossing its path walking from the nearside and the frontal structure of the bus strikes the pedestrian when it has crossed 75% of the width of the bus when no braking action is applied.

Bus-to-Pedestrian Nearside Child 50% (BPNC-50) – A test scenario representing a collision in which a bus travels forwards towards a child pedestrian crossing its path running from behind and obstruction from the nearside and the frontal structure of the bus strikes the pedestrian when it has crossed 50% of the width of the bus when no braking action is applied.

Bus-to-Bicyclist Longitudinal Adult 25% (BBLA-25) – A collision in which a bus travels forwards towards a bicyclist cycling in the same direction in front of the bus where the bus would strike the cyclist at 25% of the width of the bus assuming that no braking or steering is applied in response to any FCW issued.

Bus-to-Bicyclist Longitudinal Adult 50% (BBLA-50) – A collision in which a bus travels forwards towards a bicyclist cycling in the same direction in front of the bus where the bus would strike the cyclist at 50% of the width of the bus when no braking or steering action is applied.

Aborted Crossing Test - A scenario in which a bus travels forwards towards a child pedestrian on a crossing trajectory, walking from the nearside and, prior to the child pedestrian actually entering the path of the bus, the child pedestrian stops.

Bus Stop Test – A scenario in which a bus follows a defined curved path first left then right such that the nearside front corner of the bus passes a stationary adult pedestrian.

- **Test Service:** The organisation undertaking the testing and certifying the results to the Approval Authority.
- **Test Target (TT):** An item of test equipment accurately representing the characteristics of the relevant road user, as seen by the relevant sensing technologies used by AEB. A range of specific test targets are defined¹:

EBT: Euro NCAP Bicyclist and Bike Target – Means the bicyclist and bike target as specified in the Euro NCAP Bicyclist Target Specification document version 1.0.

EPTa: Euro NCAP Pedestrian Target – Means the adult pedestrian target with articulating legs as specified in the Euro NCAP Articulated Pedestrian Target Specification document version 1.0.

EPTc: Euro NCAP Child Target – Means the child pedestrian target as specified in the Euro NCAP Articulated Pedestrian Target Specification document version 1.0.

EVT: Euro NCAP Vehicle Target – Means the car target defined in Annex A of the Euro NCAP AEB Systems test protocol (2015).

¹ ISO standards for these test targets are under development and once published should replace the references to the equivalent Euro NCAP standards



GVT: Global Vehicle Target – Means the car target defined in the Euro NCAP Technical Bulletin TB 025.

- **Vehicle Manufacturer:** The business responsible for the manufacture of the bus being assessed.
- **Vehicle width:** The widest point of the vehicle ignoring the rear-view mirrors, side marker lamps, tyre pressure indicators, direction indicator lamps, position lamps, flexible mud-guards and the deflected part of the tyre side-walls immediately above the point of contact with the ground.
- **Vehicle Under Test (VUT):** Means the vehicle assessed according to this protocol.

4 Reference system

4.1 Local co-ordinates

A local co-ordinate system (x,y,z) for the VUT shall be defined such that the x-axis points toward the front of the bus, the y-axis towards the left and the z-axis upwards, as shown in Figure 15_1, below.

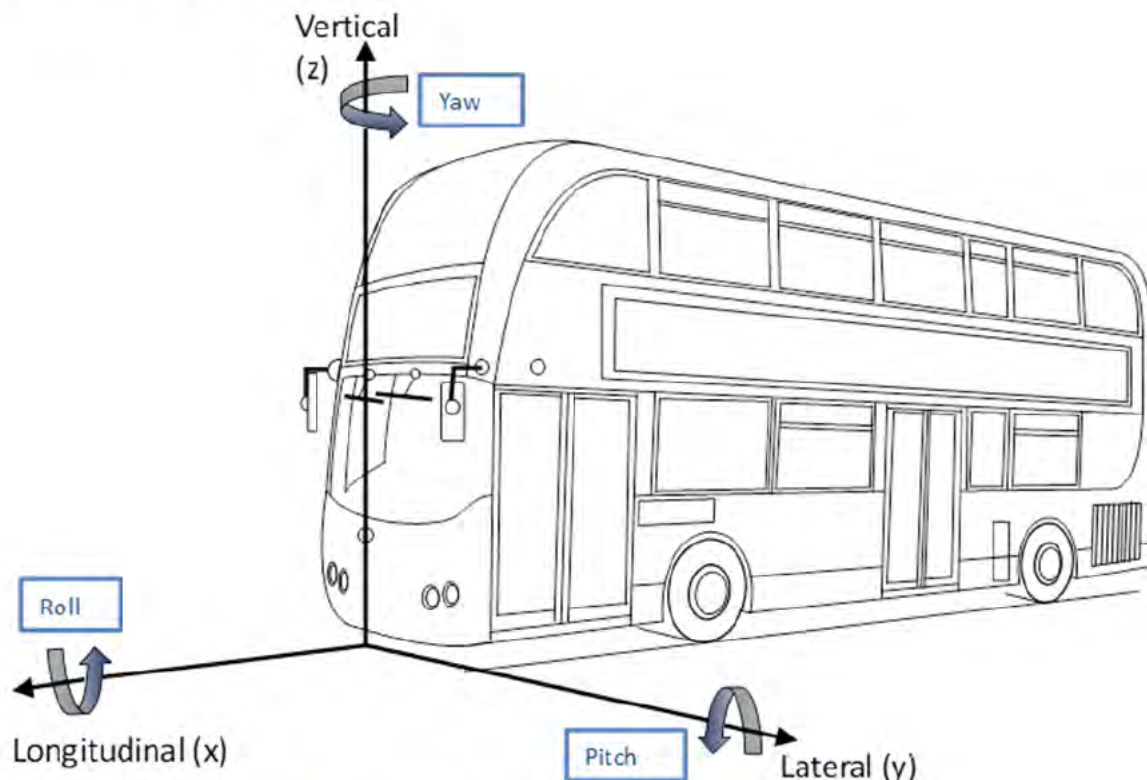

Figure 15_1: Local co-ordinate system and notation

The origin of the co-ordinate system shall lie on the ground plane, on the lateral centre line of the bus at its foremost point (ignoring the rear-view mirrors and windscreen wipers).

4.2 Global co-ordinates



A global co-ordinate system (X, Y, Z) fixed relative to the Earth shall be defined such that the global X-axis is coincident with the local X-axis of the vehicle in its initial starting position. Thus, a VRU travelling perpendicular to the initial direction of the test vehicle would be travelling along the global Y-axis.

5 Measurements and variables

5.1 Variables to be measured

Table 15_1 and Table 15_2 show the variables which must be measured, along with the minimum operating ranges and measurement accuracy required.

Table 15_1: Variables to be measured continuously during each test with minimum operating ranges and measurement accuracy

Variable	Operating range (at least)	Measurement accuracy
Time	24 Hours	GPS Time
Position (global co-ordinates) of the VUT (X_{VUT} , Y_{VUT})	400m in X and 100m in Y	$\pm 0.03\text{m}$
Position (global co-ordinates) of the TT (X_{TT} , Y_{TT})	400m in X and 100m in Y	$\pm 0.05\text{m}$
Speed of the VUT (V_{VUT})	0 km/h to 80 km/h	0.1 km/h
Speed of the TT (V_{TT})	0 km/h to 30 km/h	0.1 km/h
Heading (yaw) angle (Ψ) relative to global X-axis (Ψ_{VUT} , Ψ_{TT})	0° to 360°	0.1°
Yaw velocity of the VUT (Ψ'_{VUT})	± 50 °/s	0.1 °/s
Steering wheel velocity of the VUT (Ω'_{VUT})	± 1000 °/s	1.0 °/s
Pitch angle of the VUT (θ_{VUT})	$\pm 45^\circ$	0.1°
Roll angle of the VUT (ω_{VUT})	$\pm 45^\circ$	0.1°
Acceleration of VUT in local x-axis (A_{VUTx})	± 15 m/s ²	0.1 m/s ²
Acceleration of VUT in local y-axis (A_{VUTy})	± 15 m/s ²	0.1 m/s ²
Acceleration of TT in global y-axis (A_{TTY})	± 15 m/s ²	0.1 m/s ²
FCW Activation (FCW_A)	True/False	N/A

Table 15_2: Variables to be measured before each test with minimum operating ranges and measurement accuracy



Variable	Operating range (at least)	Measurement accuracy
Ambient Temperature	-5°C to +50°C	±1°C
Track Temperature	-5°C to +50°C	±1°C
Wind Speed	0 m/s to 20 m/s	± 0.2m/s
Ambient Illumination	0 lx to 150,000 lx	±10%

5.2 Measuring equipment

Details of the sensors used to measure the required variables shall be recorded in the test report together with the position in which they are installed within the VUT (measured relative to the local co-ordinate system for the test vehicle).

The default equipment to be used shall be a high quality inertial navigation system in combination with differential GPS. Data shall be recorded at a sample rate of 100 Hz. With such equipment, post-sampling digital filtering shall be as follows:

- a) Position and speed require no additional digital filtering after data capture;
- b) Acceleration and yaw rate shall be filtered with a phaseless digital filter complying with the requirements of ISO 15037-2:2002.

Alternatively, any measuring equipment that can be demonstrated to be compliant with the requirements of ISO 15037-2:2002 is permitted.

In addition to the data recording described above, the VUT shall be equipped with one or more video cameras positioned such that for each and every test, the TT can be clearly seen at the moment of impact, at impact points ranging from 1% to 99% of the vehicle width. A means of accurately synchronising the video feed with the data recordings shall be provided. This camera footage is intended for engineering use only in order to provide a visual reference to allow cross-checking of post-processed data. Camera mounting position, lens type etc. are not considered important for this purpose provided impact position or timing of avoidance can clearly be seen in the resulting footage.

5.3 Variables to be derived from the measurements

5.3.1 General

The variables that shall be calculated from the measured data are defined in Table 15_3.

Table 15_3: Variables to be derived from the measured data



Variable	Description	Definition/Derivation Method
A_{VUT_Long}	VUT Longitudinal Acceleration	The component of A_{VUTx} acting in the horizontal plane, or A_{VUTx} corrected for pitch angle
$A_{PEAK_VUT_Long}$	Peak Longitudinal Acceleration of VUT	The largest value of A_{VUT_Long} that occurs between the time T_{AEB} and the end of test
A_{VUT_Lat}	VUT Lateral Acceleration	The component of A_{VUTy} acting in the horizontal plane, or A_{VUTy} corrected for roll angle
T_0	The start of the test	Derived by recording the time T when the measured TTC first drops below 4s
TTC	Time To Collision	For every data point a calculation of the time taken for the VUT to reach the point of impact with the TT based on the current position of each and an assumption that the velocity of each (in the direction of travel of the VUT) remains constant
T_{AEB}	The time at which AEB activates	Find the first data point when the filtered A_{VUT_Long} is -1m/s^2 or larger, then move backwards in time to find the data point where the acceleration first crossed -0.3m/s^2 . The time at this point is T_{AEB} .
T_{FCW}	The time at which FCW activates	The time recorded at the first data point where $FCW_A=True$, based on recognition of the audible component of the warning. The means of recognition may need to vary depending on the exact system but may, for example, be achieved using a microphone in close proximity to the warning speaker where the signal is filtered with a pass band of 50Hz either side of the measured tone and dB(A) fast weighting applied, and noting the time when the weighted signal exceeds 50dB(A)
T_{Impact}	The time at which the VUT collides with the TT	See section 5.3.2.
V_{Test_VUT}	Nominal initial velocity of VUT before braking applied	Defined by specific test condition
$V_{Test_VUT_Act}$	Actual initial velocity of VUT before braking applied	Average of V_{VUT} over the 1 second immediately before T_{AEB}



Variable	Description	Definition/Derivation Method
V_{Rel_Test}	The initial speed of the VUT relative to the initial speed of the TT	Subtract the component of V_{Test_TT} acting in the same direction as the V_{VUT} from. $V_{Test_VUT_Act}$
V_{Test_TT}	The initial speed of the TT	Average of V_{TT} between T_0 and T_{AEB}
V_{Impact_VUT}	VUT velocity at the moment that it collides with the Test Target	See section 5.3.2
V_{Impact_TT}	Test Target velocity at the moment that it collides with the VUT	See section 5.3.2
V_{AEB_Red}	The reduction in VUT velocity achieved before impact as a consequence of AEB action	$(V_{Test_VUT} - V_{Rel_Impact})/V_{Test_VUT}$
V_{Rel_Impact}	The relative impact speed between VUT and TT at the moment of impact	Subtract the component of V_{Impact_TT} acting in the same direction as the V_{VUT} from. V_{Impact_VUT}
Y_{Impact_Nom}	Nominal Impact Position on VUT if no braking occurred and V_{TT} remains constant	Locate T_{AEB} in the data file. Move forward in time in the data by the number of data points equivalent to the TTC recorded at the data point corresponding to T_{AEB} . Y_{Impact_Nom} is equal to the value Y_{TT} at this data point (actual for true positive tests, calculated for aborted crossing test).
Y_{Impact_Act}	Actual Impact Position on VUT	If no impact occurred this shall be recorded as not applicable. Where impact was deemed to occur, $Y_{Impact_Act} = Y_{TT}$ when that impact first occurred.
Y_{VUT_Error}	Lateral path error of the VUT	Distance in y-axis between the centreline of the vehicle at the foremost point of the VUT at the point of impact, and the same point if the VUT had followed its intended straight path.

5.3.2 Determination of impact

Determining whether impact has occurred and, if so, at what time and speed, is undertaken using a virtual method. A virtual profile is defined around the VUT and each TT and related to the point on the VUT/TT that relates to the recording of its position (X_{VUT} , Y_{VUT} , X_{TT} , Y_{TT}). The first data point at which the recorded positions are such that the virtual profile of VUT and TT intersect is defined as the moment of collision. T_{Impact} , V_{Impact_VUT} , and V_{Impact_TT} are defined as the relevant time and speeds recorded at the moment of collision. This is illustrated in Figure 15_2.:

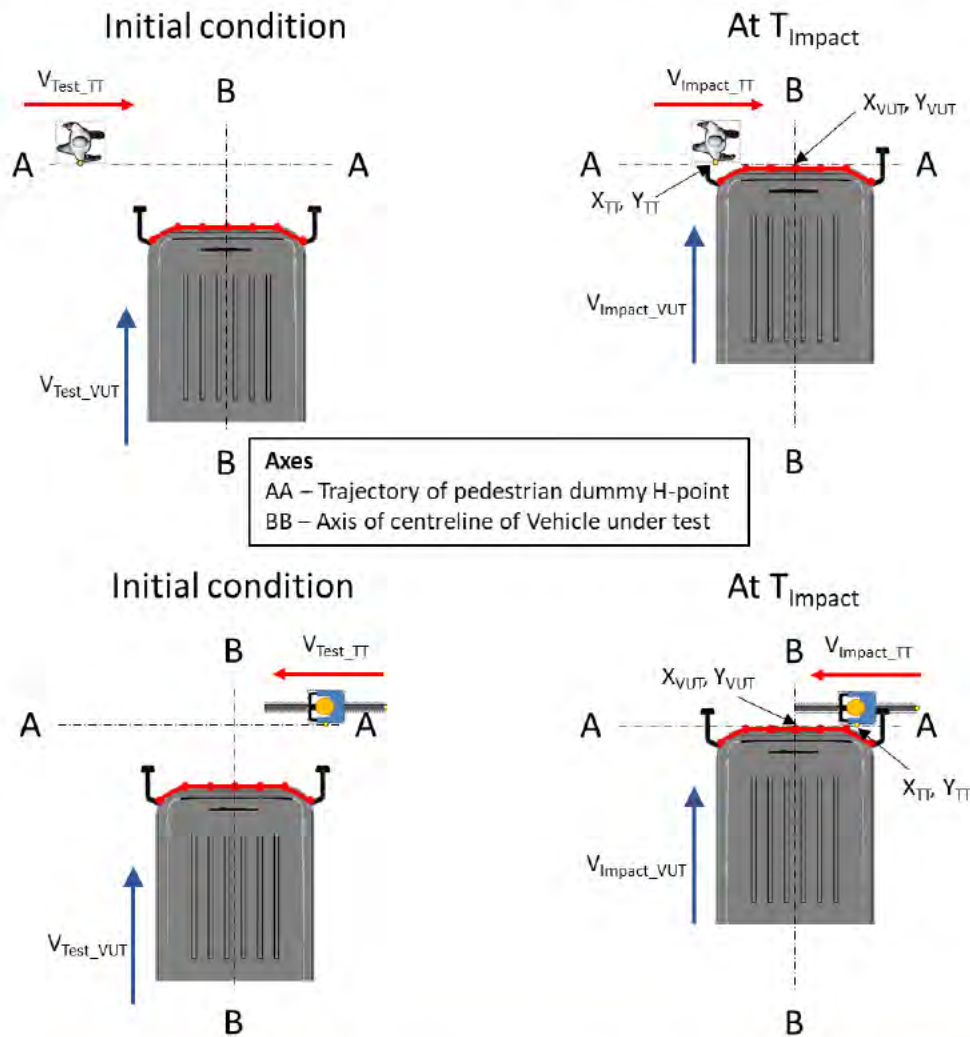

Figure 1: Illustration of the definition of the moment of impact (Pedestrian (top), Cyclist (bottom))

For the VUT, the virtual profile is defined around the front end of the vehicle by straight lines connecting seven points that are equally distributed over the vehicle width minus 50 mm on each side. The x,y coordinates of each point shall be provided by the vehicle manufacturer and checked by the organisation undertaking the tests.

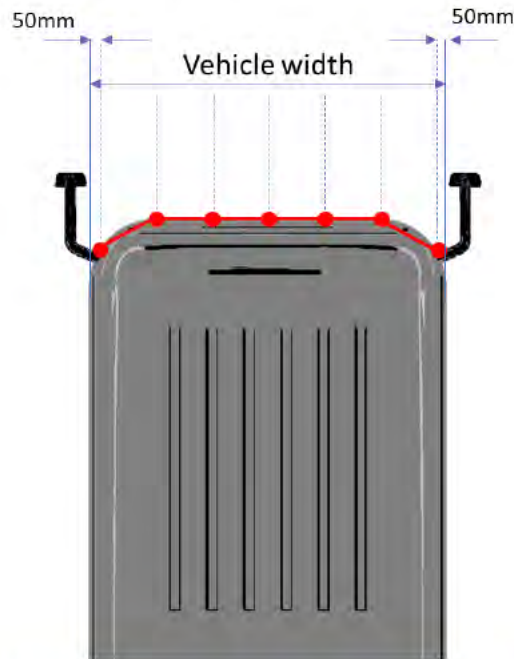

Figure 2: Virtual profile for determining impact for VUT

For the vehicle targets, EVT and GVT, they are considered essentially rectangular and should have a local X-axis completely aligned (within defined tolerances) with the local X-axis of the VUT². Thus, a single X position is defined representing the rear of the vehicle target. Impact occurs when the foremost point of the virtual profile for VUT crosses the X position at the rear of the vehicle target.

For the pedestrian targets (EPT) a virtual box is defined around the target with dimensions as shown in Figure 3. For crossing scenarios, the reference point is the X,Y position of the hip and for longitudinal scenarios, it is a virtual point positioned where the centreline of the target meets the rear of the virtual box.



Figure 3: Virtual box around EPT

For the cyclist targets (EBT), the dimensions of the virtual box are shown in Figure 4. For crossing scenarios, the reference point of the EBT is the centre of the bottom bracket (crank shaft, indicated by a dashed line in Figure 4) and for the longitudinal scenario the most rearward point on the rear wheel is used.

² Note that the GVT does in fact have a slightly curved rear profile but this does not affect the moment of impact determination in full overlap conditions as prescribed by this protocol, only in partial overlap conditions.

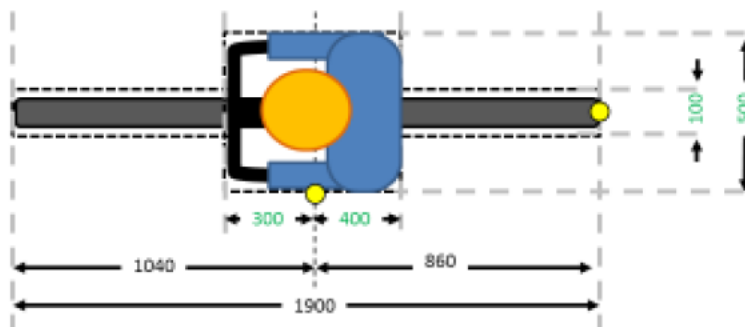

Figure 4: Virtual box around EBT

6 Test conditions

Test track

Tests shall be conducted on a dry (no visible moisture on the surface), uniform, solid-paved surface with a consistent slope between level and 1%.

The test surface shall have a minimal peak braking coefficient (PBC) of 0.9 in the region where data is recorded.

The test zone surface shall be paved and shall not contain any irregularities (e.g. large dips or cracks, manhole covers or reflective studs) that may give rise to abnormal sensor measurements.

The test zone shall extend to a lateral distance of 3.0m either side of the test path and to a longitudinal distance of 30m ahead of the VUT when the test ends.

The presence of lane markings is allowed. However, testing shall only be conducted in an area where typical road markings depicting a driving lane are not parallel to the test path within 3.0m either side. Lines or markings may cross the test path, but shall not be present in the area where AEB activation and/or braking after FCW is expected.

6.1 Weather and lighting conditions

Tests shall be conducted in dry conditions with ambient temperature above 5°C and below 40°C.

No precipitation shall be falling and horizontal visibility at ground level shall be greater than 1km.

Wind speeds shall be below 10m/s to minimise EPT, EBT and VUT disturbance. The Test Service may, at their discretion repeat tests if unexpected results are observed at a time when wind speed exceeds 5 m/s.

For daytime testing, natural ambient illumination shall be homogenous in the test area and in excess of 2000 lux for daylight testing with no strong shadows cast across the test area other than those caused by the VUT, EPT or EBT. Testing shall not be performed driving towards, or away from the sun when there is direct sunlight.

Testing at low ambient lighting conditions are defined herein as night-time tests. The conditions for those tests shall be as defined by ANNEX B of the Euro NCAP AEB VRU test protocol (2018).



6.1.1 Surroundings

Tests shall be conducted in clear surroundings such that there are no other vehicles, highway infrastructure (except lighting columns during the low ambient lighting condition tests), obstructions, other objects or persons protruding above the test surface that may give rise to abnormal sensor measurements. The clear zone shall be defined for the VUT test path as per Figure 15_6, with a longitudinal distance of 30m ahead of the VUT when the test ends and The clear zone for the EPT and EBT shall extend on all sides by 1.0m

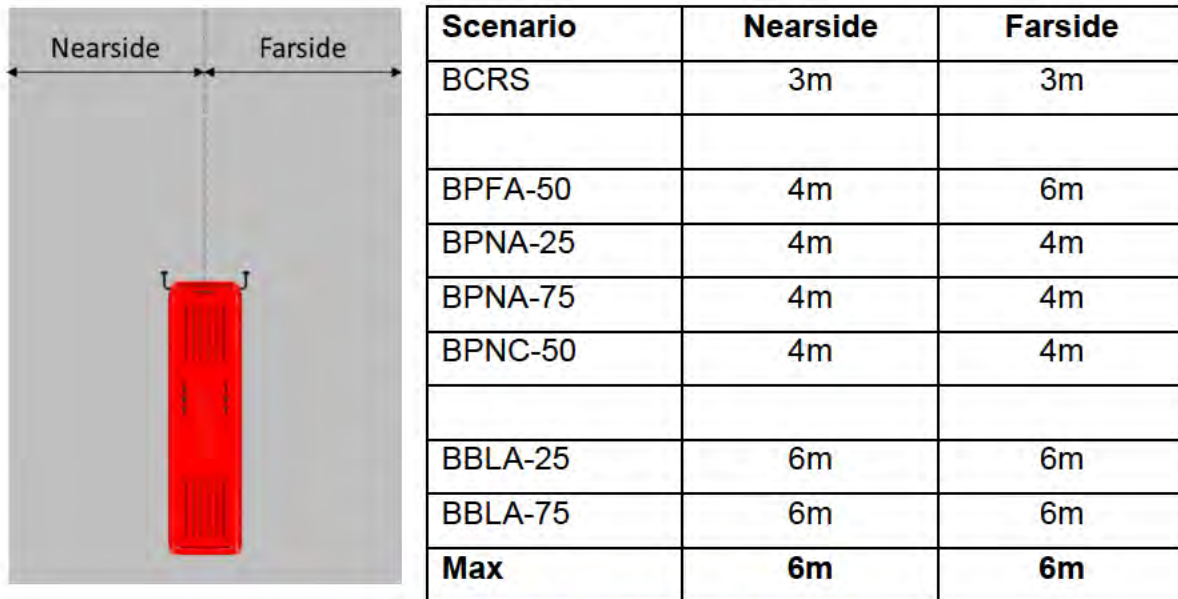

Figure 15_6: Free surroundings

Test areas where the VUT would need to pass under overhead signs, bridges, gantries or other significant structures are not permitted.

The general view ahead and to either side of the test area shall comprise of a wholly plain man made or natural environment (e.g. further test surface, plain coloured fencing or hoardings, natural vegetation or sky etc.) and shall not comprise any highly reflective surfaces or contain any vehicle-like silhouettes that may give rise to abnormal sensor measurements.

7 Vehicle preparation

7.1 Deployable protection systems

If the vehicle is equipped with any external deployable safety systems (for example, pedestrian airbag), then this should be disabled before testing commences.

7.2 Tyres

Perform the testing with new (>90% original tread depth across the tread width) original fitment tyres of the make, model, size, speed and load rating as specified by the vehicle manufacturer.



Replacement tyres are permitted and may be supplied by the manufacturer or acquired at an official dealer representing the manufacturer. Replacement tyres must be of identical make, model, size, speed and load rating to the original fitment.

Tyres shall be inflated to the manufacturers recommended pressure. They shall be set when the tyres are cold and re-checked at the start of every test day.

7.3 Wheel alignment measurement

The vehicle shall be subject to a vehicle (in-line) geometry check to record the wheel alignment in test condition.

Wheel alignment measurement shall be done with the vehicle at kerb weight.

7.4 Vehicle mass

The AEB shall be operative at all states of load.

VUT shall be tested and assessed unladen with only the driver and test equipment on board.

Each axle of the vehicle shall be weighed in the condition as tested and the measurements recorded in the test report.

At the discretion of the Approval Authority, additional tests may be undertaken in full or partial load conditions to assess the extent of any performance degradation compared to unladen.

7.5 AEB/FCW system check

As part of vehicle preparation, it is permitted to perform a maximum of 10 runs at the lowest test speed at which the system is expected to work to ensure proper functioning of the system before formal testing begins. This check may be performed using static targets without instrumentation or driving control or within a fully equipped test scenario, as deemed appropriate by the Test Service and agreed with the Vehicle Manufacturer.

7.6 Measuring front end geometry

The X-Y co-ordinates for the virtual front-end vehicle contour given by the Vehicle Manufacturer shall be verified.

When the co-ordinates specified are within 10mm of those measured by the Test Service, the co-ordinates as provided by the Vehicle Manufacturer will be used.

When the co-ordinates measured by the Test Service are not within 10mm of those supplied, or where the Vehicle Manufacturer has not provided the required data, the co-ordinates as measured by the Test Service shall be used.



8 Test procedure

8.1 VUT pre-test conditioning

8.1.1 Sensor calibration

If requested by the Vehicle Manufacturer, the Test Service shall drive a maximum of 100km on a mixture of urban roads with other traffic and roadside furniture to 'calibrate' the sensor system. Harsh acceleration and braking shall be avoided.

8.1.2 Brake conditioning

It shall be ensured that the brake assemblies are suitably run-in (also referred to as bedded in) and brake surfaces are neither brand new nor corroded.

8.1.3 Tyre conditioning

Tyres shall have been used in normal driving for at least a distance of 150km.

At the start of each sequence of testing, tyres shall be warmed up by driving for 1 km repeatedly steering left and right with a lateral acceleration of approximately 3 m/s^2 .

8.1.4 Alignment checks

Before testing is undertaken and if any unexpected performance is observed during the tests, the Test Service shall consider checking the test equipment is correctly reproducing the intended test scenario.

For BCRS tests, this shall involve a static alignment test where the VUT is positioned on the test path while just touching the rear of the TT. The vehicles shall be manually measured to ensure that the centreline of the VUT and TT are aligned. The co-ordinates that the inertial measuring system report for the VUT at that time shall be recorded and retained for reference during analysis.

For VRU tests involving crossing scenarios static and dynamic tests shall be considered.

For static tests, position the VUT on the test path with the foremost point of the vehicle positioned on the X-axis at the point where impact with the TT would be expected. Move the TT to the Y-position expected to correspond to the intended impact point (25%, 50%, 75%). Measure the distance from the TT reference point to the edge of the bus in the Y-axis and calculate the actual impact point (%). Check that error complies with requirement.

For dynamic tests, run the desired test scenario without a TT in position such that AEB does not activate. Analyse the data to identify $Y_{\text{Impact_Act}}$ and check that it complies with the requirements for that scenario.

8.2 Car tests

8.2.1 Test scenario

The performance of the VUT AEB system in the BCRS scenario is assessed in relation to a stationary target only. FCW is not assessed.

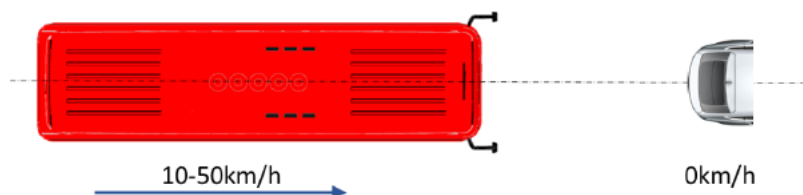

Figure 5: BCRs Scenario

The default TT is the EVT. However, the GVT may be used if requested by the Vehicle Manufacturer.

8.2.2 Sequence and number of test runs

Testing shall be commenced at the lowest test speed ($V_{TEST_VUT} = 10$ km/h). Whether to do the next test and, if so, at which test speed depends on the result of the preceding test:

- If the result of the test is complete avoidance at that speed, then the next test speed (V_{TEST_VUT}) shall be incremented upwards by 10 km/h;
- If the result of the test is contact at a speed at least 5 km/h less than the test speed ($V_{TEST_VUT} - V_{IMPACT_VUT} \geq 5$ km/h), and the test speed (V_{TEST_VUT}) was equal to 10 km/h, then the test speed shall be incremented upwards by 5 km/h;
- If the result of the test is contact at a speed at least 5 km/h less than the test speed ($V_{TEST_VUT} - V_{IMPACT_VUT} \geq 5$ km/h), and the test speed (V_{TEST_VUT}) was greater than 10 km/h, the test speed shall be reduced by 5 km/h and then subsequent tests at increased speeds incremented at 5 km/h; or
- If the result of the test was a speed reduction of less than 5 km/h ($V_{TEST_VUT} - V_{IMPACT_VUT} < 5$ km/h), or if the Vehicle Manufacturer states that they expect no performance at the next speed, then testing shall cease.

Tests shall not be undertaken at speeds in excess of 50 km/h. Only one valid test is required at each speed and the result from the first valid test shall be the result officially recorded.

Additional tests may be undertaken in order to investigate unexpected results at the discretion of the Vehicle Manufacturer, Test Service or Approval Authority. If so, the Test Service shall provide all data from repeat runs to the Approval Authority for their consideration.



8.2.3 Test execution

- a) If requested by the Vehicle Manufacturer, an initialisation process shall be completed before the first, or every, test run.

The initialisation shall involve driving the vehicle on a circular path of radius $\leq 30\text{m}$ for a distance of 190m, half of which involves a left turn and half a right turn. At the request of the Vehicle Manufacturer this may also involve driving past a small number of parked vehicles. The initialisation process shall be completed before the tyre warm up.

- b) The first test shall be commenced a minimum of 90 seconds and a maximum of 10 minutes after completion of the tyre warmup. Subsequent tests shall be completed within this same time window.

If the time between tests exceeds 10 minutes, then repeat the tyre warmup procedure.

- c) Select the normal Drive mode of the vehicle/gearbox.
- d) Accelerate the VUT to the test speed, position it on the test path and achieve steady state conditions before T_0 (TTC=4s).
- e) If the VUT instigates AEB, then the accelerator pedal shall be released. No other driving controls (e.g. clutch or brake) shall be operated during the test.
- f) The test is considered complete when one of the following has occurred:
- i. $V_{VUT} = 0 \text{ km/h}$
 - ii. VUT has made contact with the TT.

8.2.4 Validity of tests

Post-processing of data shall be undertaken to demonstrate the validity of tests. Tests are considered valid when all of the following criteria are met at all times between T_0 and T_{AEB} :

- a) $V_{VUT} \geq \text{Test Speed}$ and $V_{VUT} \leq \text{Test Speed} + 0.5 \text{ km/h}$
- b) Lateral deviation from VUT Test Path (Y_{VUT_Error}) = $0 \pm 0.05\text{m}$
- c) VUT Yaw Velocity (Ψ'_{VUT}) = $0 \pm 1.0 \text{ }^\circ/\text{s}$
- d) Steering wheel velocity (Ω'_{VUT}) = $0 \pm 15.0 \text{ }^\circ/\text{s}$
- e) Centreline of the Test Target is within $\pm 0.05\text{m}$ of the Test path and parallel to the Test path within $\pm 5^\circ$

To consistently meet these tolerances, electro mechanical control systems shall be used to apply the driving controls.

If a test is found to be non-compliant then it shall be repeated until a compliant result is achieved.

8.3 VRU crossing tests

8.3.1 Test scenarios

The performance of the system shall be assessed in the four scenarios BPFA-50, BPNA-25, BPNA-75 and BPNC-50 and these are illustrated in Figure 6 to Figure 8 . FCW is not assessed.

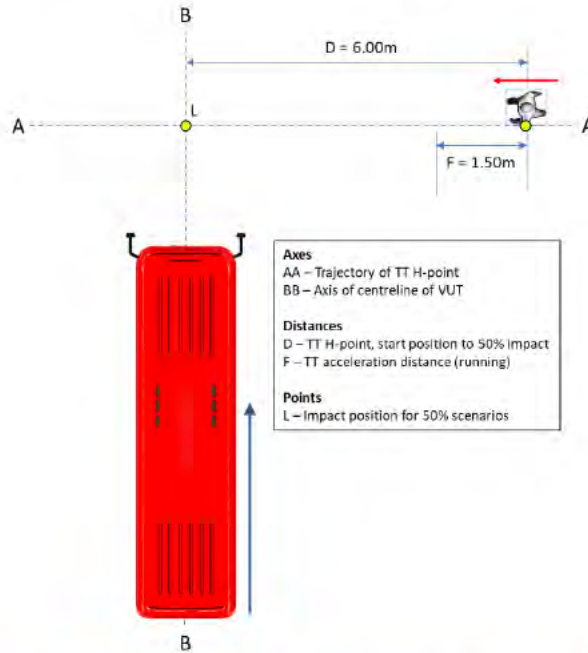

Figure 6: BPFA-50 scenario, adult running from the farside of the road

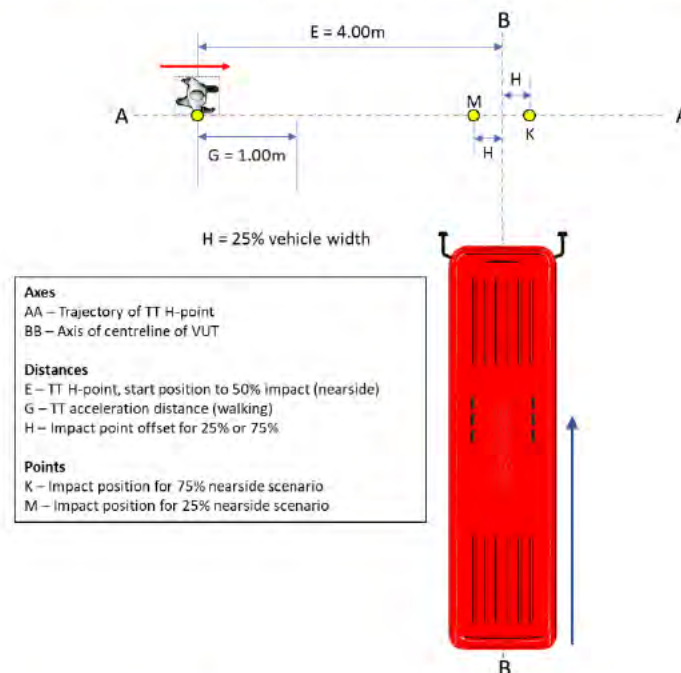

Figure 7: BPNA-25 & BPNA-75 scenario, adult walking from the nearside of the road

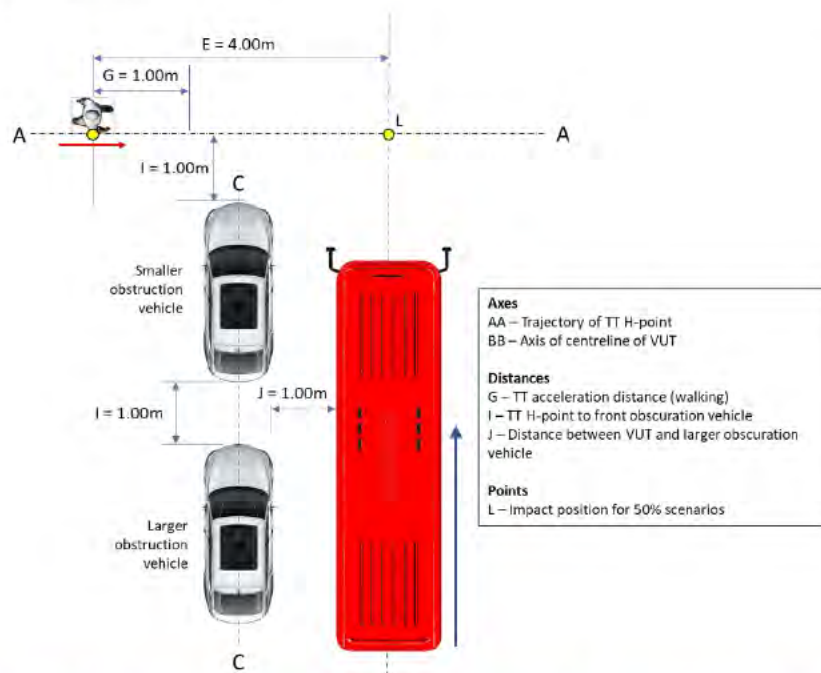

Figure 8: BPNC-50 scenario, child running from the nearside from behind obstructing vehicles

Figure 8 defines the relative position of the obstructing vehicles. The definition of the size and type of vehicles to be used is that specified in the Euro NCAP AEB VRU systems protocol (2018).

In all scenarios except BPNC-50, the TT to be used is the Euro NCAP Pedestrian Target adult dummy (EPTa). For scenario BPNC-50, the test target shall be the Euro NCAP Pedestrian Target child dummy (EPTc).

The details of the tests are shown in Table 3.

Table 3: Test variables for the VRU crossing tests

	Test Scenario			
	BPFA-50	BPNA-25	BPNA-75	BPNC-50
VUT speed (V_{TEST_VUT})	20 – 45 km/h			
TT speed (V_{TEST_TT})	8 km/h	5 km/h		
Impact location (VUT)	50%	25%	75%	50%
Lighting conditions	Day	Day & Night		Day

In addition to the tests defined in Table 3, the BPNA-75 scenario shall be tested in daylight conditions with:

- a) $V_{TEST_VUT} = 20$ km/h and $V_{TEST_TT} = 3$ km/h; and
- b) $V_{TEST_VUT} = 10$ km/h and $V_{TEST_TT} = 5$ km/h.

8.3.2 Sequence and number of test runs

VUT tests speeds (V_{TEST_VUT}) shall be increased in increments of 5 km/h, until $V_{TEST_VUT} = 40$ km/h.



VUT tests speeds in excess of 40 km/h shall only be tested when:

- a) Vehicle Manufacturer has provided data indicating an expected significant performance at the next speed increment; and
- b) $V_{TEST_VUT} - V_{IMPACT_VUT} \geq 5\text{km/h}$ where $V_{TEST_VUT} = 40\text{km/h}$

The number of test runs to be completed in each test condition and the process of determining the result to be recorded for that condition are the same as those defined in section 8.2.2.

8.3.3 Test execution

The process for executing each test shall be as defined in section 8.2.3. with the following exceptions.

T_0 is defined as being at a TTC of 6 seconds.

The test is considered complete when one of the following has occurred:

- a) $V_{VUT} = 0 \text{ km/h}$
- b) VUT has made contact with the TT
- c) The TT has crossed the full width of the VUT and moved out of its path without making contact with it

8.3.4 Validity of tests

Post-processing of data shall be undertaken to demonstrate the validity of tests. Tests are considered valid when all of the following criteria are met at all times between T_0 and activation of AEB or the end of test, whichever comes first:

- a) $V_{VUT} \geq \text{Test Speed}$ and $V_{VUT} \leq \text{Test Speed} + 0.5 \text{ km/h}$
- b) Lateral deviation from VUT Test Path (Y_{VUT_Error}) = $0 \pm 0.05\text{m}$
- c) Lateral deviation from TT path = $0 \pm 0.05\text{m}$
- d) Lateral Velocity of deviation from the TT path = $0 \pm 0.15\text{m/s}$
- e) VUT Yaw Velocity (Ψ'_{VUT}) = $0 \pm 1.0 \text{ }^\circ/\text{s}$
- f) Steering wheel velocity (Ω'_{VUT}) = $0 \pm 15.0 \text{ }^\circ/\text{s}$

Once it has reached a steady state condition, the speed of the TT shall remain at the defined speed $\pm 0.2 \text{ km/h}$. The steady state period shall commence no later than the point when the EPT has reached a lateral distance (Global Y-axis) of both:

- a) 3.0m from the VUT centreline, in tests approached from the nearside
- b) 4.5m from the VUT centreline in tests approached from the farside

In addition to this, Point L = Target value $\pm 3\%$ of vehicle width

To consistently meet these tolerances, electro mechanical control systems shall be used to apply the driving controls.

If a test is found to be non-compliant then it shall be repeated until a compliant result is achieved.

8.4 VRU longitudinal tests

Test scenarios

The VUT shall be assessed in two longitudinal scenarios. Both AEB and FCW shall be assessed. The TT shall be the Euro NCAP Bicyclist and bike Target (EBT). The test scenario is outlined in **Figure 9**, below.

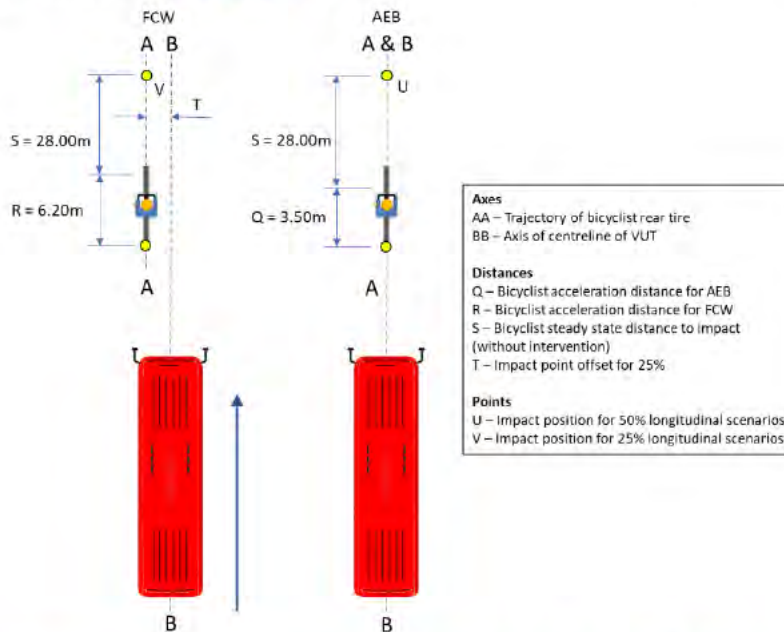

Figure 9: Longitudinal bicyclist scenarios; BBLA-25 (left) & BBLA-50 (right)

The tests to be undertaken are as defined in Table 4 .

Table 4: Test Variables: Longitudinal scenarios

	Test Scenario	
	BBLA-25	BBLA-50
Type of Test	AEB	FCW
VUT speed (V_{TEST_VUT})	50 km/h - 60 km/h	25 km/h – 60 km/h
TT speed (V_{TEST_TT})	20 km/h	15 km/h
Impact location (VUT)	25%	50%
Lighting conditions	Daylight	



8.4.1 Sequence and number of test runs

VUT tests speeds (V_{TEST_VUT}) shall be increased in increments of 5 km/h, until $V_{TEST_VUT} = 40$ km/h.

VUT tests speeds in excess of 40 km/h shall only be tested when:

- a) a Vehicle Manufacturer has provided data indicating an expected significant performance at the next speed increment; and
- b) $V_{TEST_VUT} - V_{IMPACT_VUT} \geq 5$ km/h where $V_{TEST_VUT} = 40$ km/h.

The number of test runs to be completed in each test condition and the process of determining the result to be recorded for that condition shall be as defined in section 8.2.2.

8.4.2 Test execution

The test execution shall be as specified in section 8.2.3, except that steady state shall be achieved before the time $T_0 - 1$ seconds (that is, 1 second before T_0).

For scenario BBLA-25 only, the test may be aborted if no FCW has been issued when the TTC has reduced to ≤ 1.5 seconds.

8.4.3 Validity of tests

Post-processing of data shall be undertaken to demonstrate the validity of tests. Tests are considered valid when all of the following criteria are met at all times between the time $T_0 - 1$ seconds and T_{AEB} or T_{FCW} :

- a) $V_{VUT} \geq \text{Test Speed}$ and $V_{VUT} \leq \text{Test Speed} + 0.5$ km/h
- b) Lateral deviation from VUT Test Path (Y_{VUT_Error}) = 0 ± 0.05 m
- c) Lateral deviation from TT path = 0 ± 0.15 m
- d) Lateral Velocity of deviation from the TT path = 0 ± 0.15 m/s
- e) VUT Yaw Velocity (Ψ'_{VUT}) = 0 ± 1.0 °/s
- f) Steering wheel velocity (Ω'_{VUT}) = 0 ± 15.0 °/s

Once it has reached a steady state condition, the speed of the TT shall remain at the defined speed ± 0.2 km/h. The steady state period shall commence no later than the point when the TT is positioned 22m forward of the impact point on the VUT.

To consistently meet these tolerances, electro mechanical control systems shall be used to apply the driving controls.

If a test is found to be non-compliant then it shall be repeated until a compliant result is achieved.

8.5 Aborted crossing test

8.5.1 Test scenario

This test scenario has the same geometry as that described for BPNA-25 and illustrated in Figure 7 previously. However, the TT shall be the EPTc. As per BPNA-25, the movement of the TT shall be timed such that if the TT continued at its constant steady state speed ($V_{TEST_TT} = 5 \text{ km/h}$) and the VUT maintained constant speed (without braking) and lateral position, an impact would occur 25% across the width of the VUT.

Thus, the TT motion shall be initiated as for BPNA-25. However, instead of the TT continuing at 5 km/h until the end of the test, it shall be stopped with a mean deceleration of 3 m/s^2 at Point W, where distance N is the distance from the edge of the VUT path, as illustrated in Figure 10.

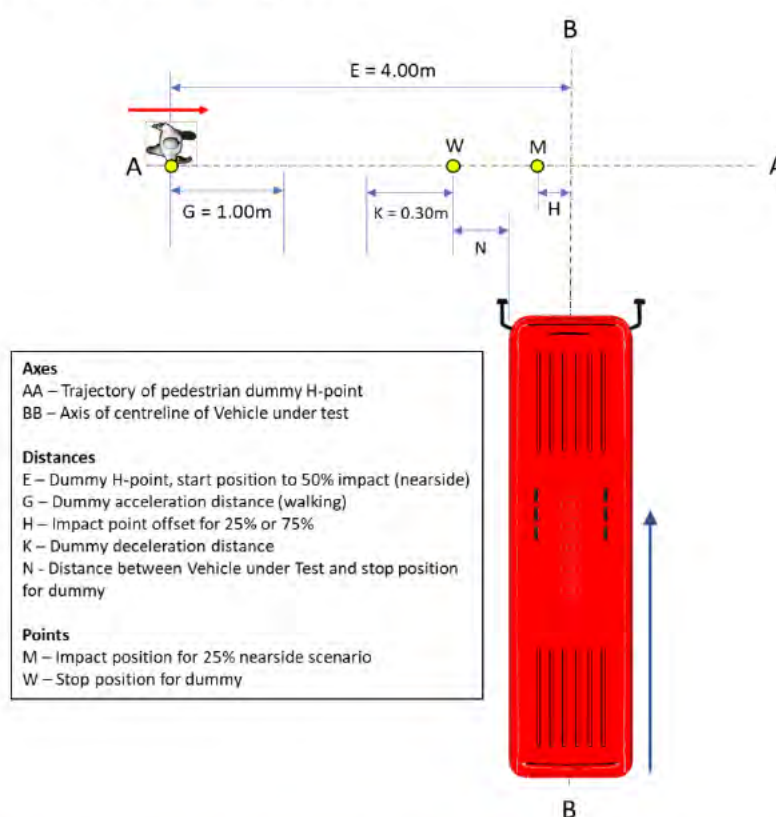

Figure 10: TT start and stop positions in aborted crossing test

Tests shall be undertaken at $V_{TEST_VUT} = 30 \text{ km/h}$ for values to $N = 0.6\text{m}$, 0.75m and 0.9m .

8.5.2 Sequence and number of test runs

The first tests shall be undertaken at $N = 0.6\text{m}$ and 3 identical tests shall be completed.

Distance N shall be increased to the next increment if the AEB activates in any of the 3 tests.

If AEB is not activated in any tests then testing can be ceased and the system will be deemed not to have activated in any of the tests at greater values of N.



8.5.3 Test execution

Accelerate the VUT to the test speed (V_{TEST_VUT}), position it on the test path and achieve steady state conditions before T_0 (TTC=4s). For buses with automatic transmission, select Drive (D). For buses with a manual transmission, select the highest gear that results in an engine speed of at least 1,000 RPM at the test speed.

If the VUT instigates AEB, then the throttle pedal shall be released. No other driving controls (e.g. clutch or brake) shall be operated during the test.

The test is considered complete one second after the TT has come to rest ($V_{TT}=0$).

8.5.4 Validity of tests

Post-processing of data shall be undertaken to demonstrate the validity of tests. Tests are considered valid when all of the following criteria are met at all times between T_0 and activation of AEB or the end of test, whichever comes first:

- a) $V_{VUT} \geq \text{Test Speed}$ and $V_{VUT} \leq \text{Test Speed} + 0.5 \text{ km/h}$ Lateral deviation from VUT Test Path = $0 \pm 0.05\text{m}$
- b) Lateral deviation from TT path = $0 \pm 0.05\text{m}$
- c) Lateral Velocity of deviation from the Test Target path = $0 \pm 0.15\text{m/s}$
- d) VUT Yaw Velocity (Ψ'_{VUT}) = $0 \pm 1.0^\circ/\text{s}$
- e) Steering wheel velocity (Ω'_{VUT}) = $0 \pm 15.0^\circ/\text{s}$

Once it has reached a steady state condition, the speed of the TT (V_{TT}) shall remain at the defined speed $\pm 0.2 \text{ km/h}$ until commencement of the deceleration phase.

The nominal impact point (Point M) shall be $25\% \pm 3\%$ of vehicle width.

The deceleration phase shall commence at the time required to achieve the intended point W. The mean deceleration shall be within $\pm 5\%$ of the target value.

To consistently meet these tolerances, electro mechanical control systems shall be used to apply the driving controls.

If a test is found to be non-compliant then the non-compliant tests must be repeated until 3 compliant runs are achieved.

8.6 Bus stop test

8.6.1 VUT path geometry

The bus stop test involves the VUT steering a defined curved path first left then right of 125m radius such that the nearside front corner of the vehicle describes the path illustrated in Figure 11 and defined by the corridor specified in XY co-ordinates in Appendix A.

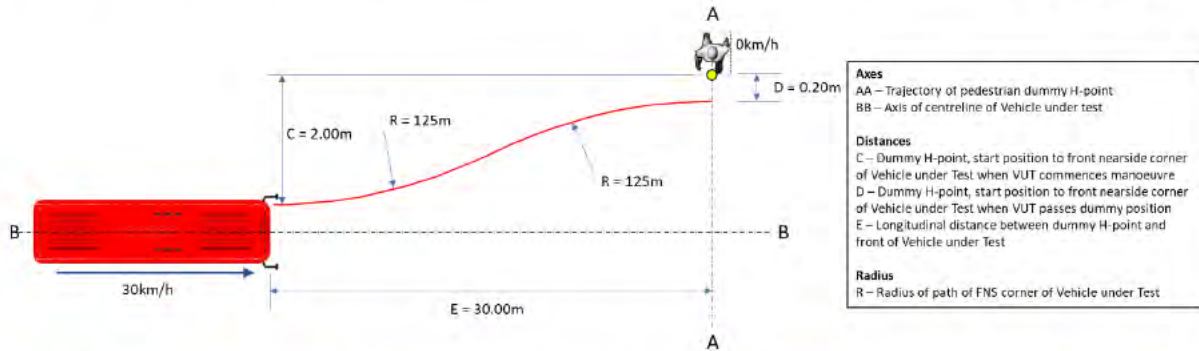

Figure 11: VUT Path and pedestrian position in false positive bus stop test

8.6.2 False positive test – TT Stationary

As shown described in Figure 15_13. The TT shall remain stationary at all times and shall be positioned such that the lateral separation (on global Y-axis), between the centre of the TT and the nearside front corner of the VUT, is initially 2m (Point C).

This distance shall reduce as the VUT approaches the TT until a distance of 0.2m (Point D) at the moment the front nearside corner of the VUT is at the same position as the TT on the Global X-axis.

V_{VUT} shall be 30 km/h and shall remain constant throughout the test unless AEB is activated.

8.6.3 True positive test – TT non-stationary

As described in Figure 15_14. The TT shall initially be positioned such that the lateral separation (on global Y-axis), between the centre of the TT and the nearside front corner of the VUT, is initially 4.55m (Point C). The TT shall be accelerated to a speed of $V_{TEST_TT} = 5$ km/h at a time such that it is on a collision course with the front of the VUT where the nominal impact point (Point L) is $50\% \pm 3\%$ of bus width. V_{TEST_VUT} shall be 30 km/h.

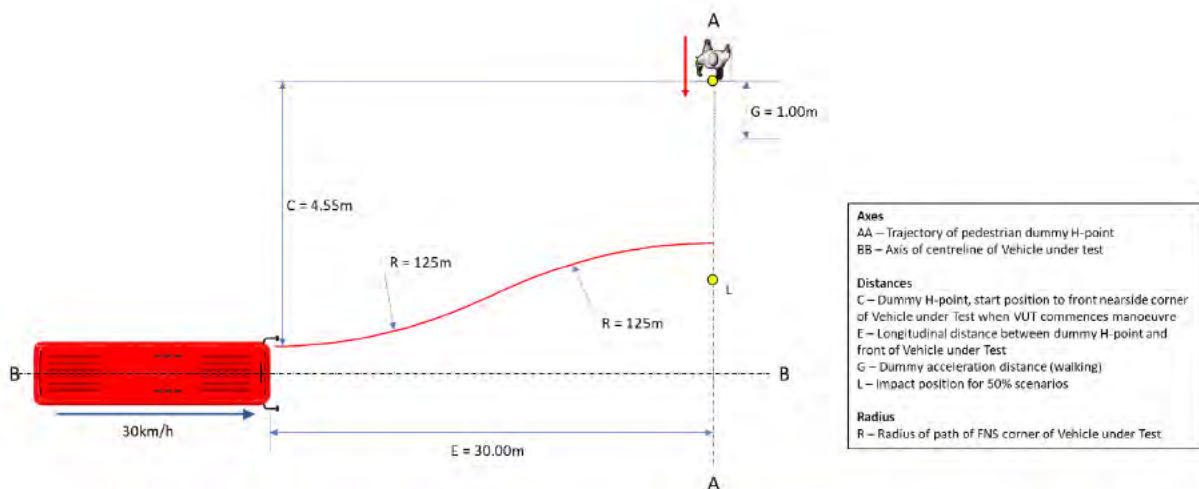

Figure 12: VUT path and TT position in true positive bus stop test



8.6.4 Sequence and number of test runs

Each test involves only one test configuration and will be completed only once.

8.6.5 Test execution

Accelerate the VUT to the test speed (V_{TEST_VUT}) in a straight line

Position the front nearside corner at a point that complies with the requirements for the first lateral position defined.

When the front of the VUT reaches a position of 30m from the TT in the global X-axis, steering is applied such that the front nearside corner stays within the corridor defined by Appendix A.

For buses with automatic transmission, select Drive (D). For buses with a manual transmission, select the highest gear that results in an engine speed of at least 1,000 RPM at the test speed.

If the VUT instigates AEB, then the throttle pedal shall be released. No other driving controls (e.g. clutch or brake) shall be operated during the test.

The test is considered complete when the foremost point of the VUT has passed the position of the TT in the global x-axis, or the VUT has come to rest, whichever occurs first.

8.6.6 Validity of tests

Post-processing of data shall be undertaken to demonstrate the validity of tests.

Tests are considered valid when all of the following criteria are met at all X_{VUT} positions between that representing entry to the corridor defined in Appendix A and activation of AEB or the end of test, whichever comes first:

- a) $V_{VUT} \geq \text{Test Speed}$ and $V_{VUT} \leq \text{Test Speed} + 0.5 \text{ km/h}$
- b) Front nearside corner remains in defined corridor

To consistently meet these tolerances, electro mechanical control systems shall be used to apply the driving controls.

If a test is found to be non-compliant then the non-compliant test shall be repeated.

8.7 Validation of Vehicle Manufacturer supplied test data

The procedures as outlined above are intended to be applicable as an independent assessment of a bus equipped with AEB capable of standing alone. Where a Vehicle manufacturer supplies a Test Service with a prediction of performance in each test condition in terms of both an expected impact speed (0km/h if it is expected that the system will avoid impact) and, where applicable, the peak deceleration applied to achieve that result, a reduced burden procedure can be undertaken. The Test Service will randomly select a sample of test conditions in which to verify the Vehicle Manufacturer's result, ensuring a broad cross section of variables are covered which must include:

- a) For car scenarios, a minimum 3 of 5 test conditions
- b) For crossing scenarios, a minimum 16 of 32 test conditions



- c) For longitudinal scenarios, a minimum 6 of 11 test conditions
- d) Aborted crossing and bus stop tests shall always be completed in full.

9 Assessment of results

9.1 Assessment criteria

The true positive performance of AEB shall be assessed using the criteria (V_{AEB_Red}). This is defined as the difference between the test speed and the impact speed, expressed as a percentage of the test speed, where the impact speed is considered to be 0km/h when the impact is avoided.

For the longitudinal cyclist tests the test and impact speeds are defined as the relative speeds of the VUT and the TT. An example of this is shown in Table 15_6.

Table 5: Example V_{AEB_Red} for longitudinal cyclist tests

Condition	VUT	TT	Relative
Test Speed (km/h)	50	15	35
Impact Speed (km/h)	30	15	15
V_{AEB_Red} (km/h)			-20
V_{AEB_Red} (%)			57%

FCW shall be assessed on a binary basis, based upon the TTC at the moment the warning is issued (TFCW). When $TFCW \geq 1.7$ seconds then the score shall be 100%. Where $TFCW < 1.7$ seconds, then the score shall be 0%.

9.2 Pre-conditions

The score awarded for AEB will be zero unless the following pre-conditions are met:

- a) In test BPNA-75 with $V_{TEST_TT} = 3$ km/h and $V_{TEST_VUT} = 20$ km/h then V_{AEB_Red} shall exceed 25% in both day & night conditions
- b) In test BPNA-75 with $V_{TEST_TT} = 5$ km/h and $V_{TEST_VUT} = 10$ km/h then V_{AEB_Red} shall exceed 25% in both day & night conditions
- c) The AEB system shall default ON at the start of every journey. It shall not be possible for the driver to easily switch off the system. It shall be possible for technicians to enable a service mode that deactivates it for maintenance and test purposes (for example when placed on a rolling road/brake rollers).
- d) AEB must not activate in the false positive bus stop test.
- e) V_{AEB_Red} shall be no less than 1 km/h in the true positive bus stop test.

9.3 Test scenario and crash type scores

Each individual test scenario comprises several individual tests at different initial test speeds. Weightings shall be applied to each individual test within each test scenario and crash type. The speed weightings are defined in the following sections.



9.3.1 Car tests

For scenario BCRS, the score for the test scenario shall be calculated from each individual test run as per the example given in Table 15_7.

Table 15_7: Scoring and weighting applicable to scenario BCRS

Test Speed (km/h)	A	B	C = A*B
	V _{AEB_Red}	Speed Weighting	Weighted score
10	100.0%	5.0%	5.0%
15	100.0%	5.0%	5.0%
20	100.0%	20.0%	20.0%
25	100.0%	15.0%	15.0%
30	100.0%	15.0%	15.0%
35	100.0%	20.0%	20.0%
40	60.0%	10.0%	6.0%
45	20.0%	5.0%	1.0%
50	0.0%	5.0%	0.0%
Total (Scenario Score)			87.0%

The total of the weighted scores for each test speed shall become the scenario score. The car tests only use one test scenario and therefore the scenario score is also the crash type score.

9.3.2 VRU crossing tests

For the VRU crossing tests the score shall be calculated for each individual test run as per the example given in Table 15_8.

Table 15_8: Scoring and weighting applicable to each VRU crossing scenario

Test Speed (km/h)	A	B	C = A*B
	V _{AEB_Red}	Speed Weighting	Weighted score
20	100.0%	20.0%	20.0%
25	100.0%	20.0%	20.0%
30	53.0%	20.0%	10.6%
35	40.0%	20.0%	8.0%
40	20.0%	10.0%	2.0%
45	0.0%	10.0%	0.0%
Total (Scenario Score)			60.6%

The total of the weighted scores for each test speed shall become the scenario score. The process shall be repeated for each of the VRU crossing scenarios.

Each of the different VRU scenarios shall also be weighted according to casualty prevention potential to produce a crash type score for all VRU crossing scenarios. Table 15_9 provides an example of the scenario weighting and the calculation.



Table 15_9: Scoring and weighting to combine scenario scores to crash type score

Scenario	A	B	C = A*B
	Scenario Score	Scenario Weighting	Weighted score
BPFA-50 (Day)	60.6%	15.0%	9.1%
BPNA-25 (Day)	75.4%	26.0%	19.6%
BPNA-25 (Night)	60.7%	22.0%	13.4%
BPNA-75 (Day)	91.0%	18.0%	16.4%
BPNA-75 (Night)	80.0%	15.0%	12.0%
BPNC-50 (Day)	70.0%	4.0%	2.8%
Total (Crash Type Score)			73.2%

9.3.3 VRU longitudinal tests

The VRU longitudinal tests assess both AEB and FCW. The principles for AEB are identical to the crossing scenarios. Forward collision warning shall be assessed according to TFCW. The scores shall be calculated for each individual test run as per the example given in Table 15_10

Table 6: Scoring and weighting for VRU longitudinal tests

Test Speed	BBLA-50 (AEB)			BBLA25-(FCW)		
	A	B	C = A*B	D	E	F=D if E≥1.7
	V_{AEB_Red}	Speed Weighting	Weighted score	Speed Weighting	T_{FCW}	Weighted score
25	100.0%	20.0%	20.0%			
30	100.0%	20.0%	20.0%			
35	80.0%	20.0%	16.0%			
40	40.0%	15.0%	6.0%			
45	0.0%	10.0%	0.0%			
50	0.0%	5.0%	0.0%	40.0%	1.8	40.0%
55	0.0%	5.0%	0.0%	30.0%	1.6	0.0%
60	0.0%	5.0%	0.0%	30.0%	1.5	0.0%
Total (Scenario score)			62.0%	Total (Scenario score)		40.0%
Scenario weighting			75.0%			25.0%
Total (Crash type score)						71.5%

The total of the weighted scores for each test speed shall become the scenario score. Each scenario is weighted to then produce a combined score for the whole crash type.



9.3.4 False positive aborted crossing scenario

The results of the aborted crossing scenario shall be interpreted in terms of the peak acceleration ($A_{PEAK_VUT_Long}$) measured during any activation. Where the system does not activate $A_{PEAK_VUT_Long}$ shall be deemed to be zero. Points shall be awarded for each individual test configuration on the following basis:

- a) In tests where $Y_{TTStop} = 0.6m$
 - i. $A_{PEAK_VUT_Long} \leq -7m/s^2$: 0 Points
 - ii. $A_{PEAK_VUT_Long} > -7m/s^2$ AND $< 0m/s^2$: 2 Points
- b) In tests where $Y_{TTStop} > 0.6m$
 - i. $A_{PEAK_VUT_Long} \leq -7m/s^2$: 0 Points
 - ii. $A_{PEAK_VUT_Long} > -7m/s^2$ AND $< 0m/s^2$: 1 Points
 - iii. $A_{PEAK_VUT_Long} = 0 m/s^2$: 2 Points

The total score for each individual test configuration shall be summed and divided by the maximum possible score (18) and expressed as a percentage Scenario Score as per the example given in

Table 7.

Table 7: Scoring for false positive aborted crossing tests

Y_{TTStop}	Test 1	Test 2	Test 3	Total
0.6m	0	0	2	2
0.75m	1	2	1	4
0.9m	2	2	2	6
Total				12
Scenario Score				66.7%

9.4 Overall score

The scores by crash type shall be converted to an overall score for AEB according to weightings based on London bus collision data. A worked example is shown in Table 15_12.

Table 8: Scoring & Weighting to produce overall AEB result

Crash Type	A	B	C= A*B	D	E = C*D
	Crash type score	Crash type weighting	Weighted score	Performance type weighting	Weighted performance score
Car	87.0%	10.0%	8.7%	80%	59.6%
VRU crossing	73.2%	85.0%	62.2%		
VRU longitudinal	71.5%	5.0%	3.6%		



False positive: aborted crossing	66.7%	100.0%	66.7%	20%	13.3%
Total (Overall AEB Score)					72.9%

10 Test report

The Test Service shall provide a comprehensive test report that will be made available to the Approval Authority. The test report shall consist of three distinct sections:

- a) Performance data
- b) Confirmation of protocol compliance
- c) Reference information

The minimum performance data required is:

- a) The value V_{Impact} and $APEAK_VUT_Long$ for each and every individual test run, with the number of tests reported based on the rules in, for example, section 8.2.2
- b) For BBLA-25 the performance output is the TTC at T_{FCW} .

To confirm protocol compliance, the Test Service shall:

- a) Make available the video recordings as specified in section 5.2
- b) Include in the report processed data (e.g. graphs, tables etc.) that show that each test was compliant with its respective section on validity of tests
- c) Provide data on environmental validity criteria, including temperature, weather and lighting measurements, demonstrating compliance with respective limit values

The reference information required includes as a minimum:

- a) Vehicle make
- b) Vehicle model
- c) Vehicle model variant
- d) AEB hardware version (e.g. sensor types, ECU references)
- e) AEB software version
- f) Tyre make/model/size/pressure
- g) Test weight
- h) Make, model, serial number of key control and measurement equipment
- i) Details of the Test Service
- j) Test date(s)



Appendix A - Co-ordinate corridor defining the path to be followed by the front nearside corner of the VUT

The co-ordinates defined below are based on the global co-ordinate system as defined in section 8.6.1, assuming the vehicle width is 2.5m. For different vehicle widths all target Y values shall be adjusted by half the difference in width. However, the important element is not the initial offset in Y but the difference in Y between the TT and the VUT initial position and the difference between the VUT Y-position at any given X and its initial Y-Position at X=0.

X	Target Y	Y Position	Corridor which NSF of VUT must lie within
0.00	1.25	1.20	1.30
1.00	1.25	1.20	1.30
2.00	1.27	1.22	1.32
3.00	1.29	1.24	1.34
4.00	1.31	1.26	1.36
5.00	1.35	1.30	1.40
6.00	1.39	1.34	1.44
7.00	1.45	1.40	1.50
8.00	1.51	1.46	1.56
9.00	1.57	1.52	1.62
10.00	1.65	1.60	1.70
11.00	1.73	1.68	1.78
12.00	1.83	1.78	1.88
13.00	1.93	1.88	1.98
14.00	2.04	1.99	2.09
15.00	2.15	2.10	2.20
16.00	2.27	2.22	2.32
17.00	2.38	2.33	2.43
18.00	2.48	2.43	2.53
19.00	2.57	2.52	2.62
20.00	2.65	2.60	2.70
21.00	2.73	2.68	2.78
22.00	2.80	2.75	2.85
23.00	2.86	2.81	2.91
24.00	2.91	2.86	2.96
25.00	2.95	2.90	3.00
26.00	2.99	2.94	3.04
27.00	3.01	2.96	3.06
28.00	3.03	2.98	3.08
29.00	3.04	2.99	3.09
30.00	3.05	3.00	3.10



Attachment 16: Advanced Emergency Braking (AEB) Guidance Notes

1 Introduction

Advanced Emergency Braking (AEB) is a system that uses forward looking sensors such as Lidar, Radar, and/or Cameras to identify a risk of an imminent collision. It will typically first warn the driver of the risk and, if the driver does not react, apply braking automatically to avoid the collision or to reduce the collision speed and therefore the potential for injury.

TfL intend to run a trial on some routes to determine whether AEB is effective when fitted to London buses.

This document sets out the guidance notes related to the fitment of AEB. These guidance notes are aimed at bus operators and manufacturers as a practical guide for implementation of the Bus Safety Standard.

These notes are for guidance only, and are not legally binding. In all circumstances, the guidance provided by a manufacturer of the bus or system shall take precedence, and these guidance notes are only for use in the absence of other information. These are not intended to be exhaustive, but to point the operators toward practical advice and questions to raise with manufacturers/suppliers.

2 Selection of buses/systems

Any bus that meets the TfL Bus Vehicle Specification.

AEB shall be provided on all new build buses, within the AEB road trial. The road trial is being undertaken to increase understanding of system effects before full implementation.

It shall not be retrofitted unless sufficient evidence can be provided to TfL that systems can be implemented safely and robustly.

2.1 Compliance and warranty

As part of the acceptance procedure for new buses, they will be tested against TfL's Test and Assessment protocol for AEB, Attachment 15. In order to be accepted, new buses must attain a score greater than zero for AEB - the higher the score the better.

A bus operator should ask to see compliance certificates for UNECE Regulation 13 and warranty information for the brake system from the bus manufacturer and/or the AEB system supplier. The bus operator must be able to present certificates to TfL as evidence that the bus brake system will continue to operate safely.

A bus manufacturer should work with any brake or AEB system suppliers to ensure that UNECE Regulation 13 requirements are met, and that warranty on the brake system is maintained. The bus manufacturer must be able to present certificates to TfL as evidence that the bus brake system will continue to operate safely.



2.2 Normal Operation

A bus operator should ask to see evidence of how well the system performs when it is activating in the situations it is intended to activate in. This should include the results and scoring from the AEB solution test and assessment protocol document. This protocol includes a variety of physical tests designed to assess the ability of an AEB system fitted to a bus to avoid or mitigate collisions with other road users while minimising risks to occupants of the bus from unnecessary brake interventions.

2.3 False positive activations

All AEB systems carry a risk that the sensors ‘misjudge’ a particular traffic situation such that a warning function or even automated braking are applied in a situation where it would not be intended to act, otherwise known as a false positive activation.

It is important that an AEB system causes as few braking events resulting from false positive activations as possible. The manufacturer shall target zero false positive activations and will need to demonstrate evidence to TfL that the vehicle is capable of driving for at least 600,000km in mixed London traffic without any false positives.

A bus operator should ask to see the evidence from the bus manufacturer and/or AEB system suppliers that demonstrates that their vehicles have been rigorously tested and there is evidence to show the distance travelled during development of the AEB system without any false positive activations occurring. Such a test programme must cover an extensive range of environmental conditions, events and scenarios that are representative of those that could reasonably be expected to occur in service. This may involve documents showing how far has been driven in dense city environments for the base system used across different vehicles and specifically for the system as fitted to the specific bus in question and the number of false positive activations. The evidence can relate to the manufacturers tuning process, in which case it is permissible for the system to have suffered a false positive activation if there is evidence to show that the algorithm was tuned to eliminate that effect and that this was demonstrated to work in a computer simulation using the actual sensor inputs recorded by the system when the activation first occurred.

2.4 False negatives

It should be noted that systems are not guaranteed to successfully detect an imminent frontal collision in all circumstances. There are some circumstances in which it is not designed to activate. Even in situations it is designed to activate in, unusual permutations of conditions can come together to cause it to fail to detect the object. These instances are known as false negatives.

2.5 Balancing risks

The TfL requirements are open and flexible. Although certain minimum standards must be met or it will fail to meet the requirements of the bus vehicle specification, there is still very considerable room for industry to choose the level of system performance that they think will work best for their particular operation. For example, TfL will attempt to commercially incentivise systems that maximise the potential to avoid collisions. However, some manufacturers may produce systems that apply



only partial braking in an emergency, or differ in terms of the vehicle speed that the system will be active at. Operators should aim to consult different manufacturers to identify any such differences, explain the rationale and then decide which best suits their corporate aims, balancing any incentives with the effect on any internal objectives.

2.6 Monitoring

AEB is new to the bus market and London will be a pioneer in implementing it. Any brake activation, human or automated, has the potential to cause injury to bus occupants. The AEB system cannot apply braking that is any more severe than a skilled driver could. However, in a false positive brake activation this creates a risk that would not exist if the advanced braking system did not exist. TfL has, therefore, mandated that if an AEB system is fitted, it must make data available for recording via the CCTV system or some other suitable method.

It is very important that operators capture as much of this data as possible, monitor it closely and report it to TfL. Current practice with CCTV is that operators make a semi-permanent download of CCTV data every time there is an incident which the driver feels could result in a complaint or some form of claim. As a minimum, any observed activation of AEB should be considered as such an incident and result in data recording and retention and reporting to TfL.

However, the above system is reliant on the driver. In false positive activations, a full brake stop should be relatively rare. Most will be a very short duration stab on the brakes, very quickly released again. Drivers may not realise that it was caused by AEB and hence not report appropriately. Similarly in true positive situations where genuine collision risk existed, there may be an incentive for drivers not to report AEB activation because they may feel it would highlight some shortcoming in their driving. It would, therefore be preferable if the data provided by the AEB could trigger an automatic record and alert to the operator. This would ensure a more accurate assessment of the operational success of the system or alternatively flag any emerging problems earlier.

3 Training

3.1 For test services

The AEB solution test and assessment protocol contains many similarities to the tests carried out on passenger cars by EuroNCAP and by regulatory authorities on HGVs. Therefore test houses accredited to undertake Euro NCAP tests or to undertake approval tests to UNECE Regulation 131 will be considered suitable to undertake performance tests. Test services without such accreditation will be required to demonstrate to TfL, at their own expense, that they can achieve the same standard of testing as an accredited organisation.

3.2 Bus drivers

An AEB system is only aimed at preventing rare occurrences where the driver has not already taken any/sufficient braking action in order to avoid an imminent collision.



As such, the system should be entirely invisible to the drivers for the vast majority of their driving time.

In principle therefore, the drivers don't necessarily need to be trained in exactly how the system works. However, it may be beneficial to inform them how the system will operate, e.g. the specific audible and/or visual warnings, how the system will apply the vehicle's brakes, and any specific action(s), if any, required by the driver to return to normal driving following an activation. One key message for drivers is that this is a system of last resort, intended to work in situations that develop faster than they can reasonably react or where they have not been able to pay full attention to the risk for whatever reason. It does not replace any part of the driving task or their responsibility for safe operation of the vehicle and will not work in all circumstances, environments or weather conditions. Under no circumstances should they attempt to demonstrate its operation or rely on it to stop the vehicle in a situation they are capable of dealing with.

Unless automatic monitoring is implemented, drivers should be encouraged to report every activation of the system in whatever driving circumstance it occurs.

3.3 Shift Supervisors

Shift supervisors should be trained in how the system works and the monitoring and reporting requirements. In the event that the system develops a fault, then, unless the manufacturer advises differently, they should understand this as an 'amber' warning where the loss of capability is explained to the driver and the vehicle is taken out of service for repair as soon as possible. The system should fail safe in that it will simply stop providing the benefit rather than cause any new problems. As such it is not necessary to stop immediately (e.g. at the roadside) in the case of a warning light illuminating in the cab.

3.4 Bus maintenance engineers

The engineers carrying out general bus maintenance should be aware of the location and details of any sensors related to the AEB system. Training should be based on the manufacturers' guidance. However, this is likely to include understanding the importance of ensuring the sensors are correctly aligned, undamaged and unobstructed since the performance of the AEB system is completely contingent on the sensors the system is connected to.

A bus operator should ask the bus manufacturer and/or AEB system supplier to provide guidelines in the event that the windscreen/grille area in front of sensor becomes damaged, or if the performance of the system has degraded.

4 Maintenance

Operators are encouraged to establish what (if any) daily checks are required, and to plan for these additional operational costs. Each manufacturer will have a set of maintenance requirements for their systems. These can vary quite significantly between manufacturers, and Operators should discuss these requirements with their suppliers to ensure that all of the implications are considered at the purchase stage and, thereafter, in routine operation. Most systems will require that the areas that sensors are installed in remain clean, undamaged and clear of any possible



obstruction not part of the original design. In short, do not mount any ancillary equipment in the field of view of the sensors.

When damage occurs in the area of the sensor, it is possible that it may become misaligned and this can significantly impair AEB performance.

Some sensors can automatically self-align to some degree in order to compensate for minor disturbances. Others cannot and will require resetting after every disturbance. Once a sensor has been disturbed, most will require some form of reset and/or recalibration process. This process can vary substantially, from a simple software reset, through simple calibration processes easily undertaken in a workshop environment, to a need for very specialist equipment and/or large spaces to enable dynamic manoeuvres to be safely undertaken. This can have significant cost implications in the event of damage/disturbance. In particular, in the passenger car market it was found that some camera based systems required complex and expensive recalibrations after windscreen replacement whereas others did not require any intervention. Operators should check the specific requirements of the systems being offered by their suppliers with preference for self-aligning systems with low burden recalibration requirements.

5 Repair

If during system maintenance checks (4) any of the sensors are deemed to be faulty or failing they should be replaced as soon as possible. The AEB system's effectiveness and reliability is completely contingent on the performance of the sensors the system is connected to. However, unless the manufacturer advises to the contrary, the system should fail safe such that it is not necessary to stop the vehicle immediately, for example, at the side of the road.

Attachment 17: Intelligent Speed Assistance (ISA) Assessment Protocol

1 Introduction

This document presents a procedure for objectively assessing the performance of systems fitted to new buses in order to restrict their speed to within the prevailing speed limit. These systems are collectively known as Intelligent Speed Assistance (ISA).

ISA systems are provided to assist drivers to keep within the speed limit, but do not absolve the driver of this responsibility. These systems only act to limit the vehicle response to the accelerator pedal input whilst the bus is travelling within a speed limit zone and do not actively control the vehicle speed..

For full understanding of this Attachment it should be read in conjunction with the Attachment 18: Intelligent Speed Assistance (ISA) Guidance Notes and New Bus Specification, Section 4.3.3.

2 Scope

This protocol applies to all new buses intended for service under contract to TfL that are passenger vehicles with a maximum mass exceeding 5 tonnes and a capacity exceeding 22 passengers. The passenger vehicles will be capable of carrying seated but unrestrained occupants and standing occupants. Such vehicles are categorised the Consolidated Resolution on the Construction of Vehicles (R.E.3) as M₃; Class I, Class II.

3 Purpose

The purpose of this assessment is to test the ability of the ISA system fitted to a bus to restrict the speed of the bus to the prevailing speed limit. This protocol provides all parties involved (specifically bus Original Equipment Manufacturers (OEMs), test services, assessors) with instructions regarding the test and assessment of ISA systems.

4 Normative references

The following normative documents, in whole or in part, are referenced in this document and are indispensable for the correct application of this test and assessment protocol. For dated references, only the edition cited applies. For undated references, the latest edition of the referenced document (including any amendments) applies.

- London Bus Service Limited New Bus Specification Section 4.3.3
- London Bus Service Limited New Bus Specification – Attachment:18 Intelligent Speed Assistance (ISA) Guidance Notes



- UN ECE Regulation 39 Uniform Provision concerning the approval of vehicles with regard to the speedometer and odometer equipment including its installation

5 Definitions

For the purpose of this Protocol:

- **AA: Approval Authority** – The Approval Authority is the body within TfL that certifies that a bus is approved for use in the TfL fleet and assigns its score under the bus safety standard for use in procurement processes
- **ISA: Intelligent Speed Assistance** – system fitted to a vehicle to restrict its speed to the prevailing speed limit
- **ROM: Restricted Operating Mode** – A condition where the ISA system actively prevents acceleration beyond the prevailing speed limit
- **TS: Test Service** – The organisation undertaking the testing and certifying the results to the Approval Authority
- **Vehicle Speed** – Measurement of the vehicle speed shall be taken by the Test Service using the vehicle CAN. This measurement shall be used for all assessments and comparison to Target Speed and Speed limits. The CAN speed shall comply with the accuracy requirements of UN ECE Regulation 39 and shall be reflected on the Speedometer..
- **Target Speed** – The vehicle speed which must be achieved as defined in each Test procedure of this protocol. The vehicle speed must be maintained within ± 2 mph of any target speed defined during each test procedure.
- **Speed Limit** – The maximum acceptable vehicle speed within any specific zone of the Digital Speed Map. Should the VUT vehicle speed be 2mph greater than the Speed limit, the speed limit shall be said to have been exceeded.
- **Test Track** – Any sealed area of carriageway without general access to the public
- **Digital Speed Map** – An electronic map which indicates the speed limit of roads. This may be for On-Road use, provided by TfL, or Test Track, provided by ISA system supplier, OEM or TS.
- **OEM: Original Equipment Manufacturer** – The company responsible for the manufacture of a completed bus, delivered to a bus operator
- **Test Service:** The organisation undertaking the testing and certifying the results to the Approval Authority.
- **VUT: Vehicle Under Test** - means a vehicle that is being tested to this protocol.
- **Zone** – An area of the Digital Speed Map with a specified speed limit



6 Test Conditions

6.1 Test environment

The test procedure requires that the VUT is tested by driving it both in areas away from the public (referred to as a test track), and on the public highway.

A test track area shall be used by the TS which permits the various tests required (10mph, 20mph, 30mph, unrestricted). The coordinates and speed limits shall be provided to TfL which will incorporate the details in to the TfL Digital Speed Map. The test track shall:

- a) Be a dry (no visible moisture on the surface), uniform, solid-paved surface with a consistent slope between level and 1%
- b) Be paved and shall not contain any irregularities (e.g. large dips or cracks, manhole covers) which might excessively slow the VUT.

An on-road route shall be devised by the TS which starts at least 1km outside the geographical area covered by the TfL Digital Speed Map. , At one point within the TfL Digital Speed Map zone, the bus will be stopped and the system powered down, restarted and the journey continued. The route shall incorporate 20mph, 30mph, and 40mph sections with transitions between each.

6.2 Weather and lighting

Tests shall be conducted in dry conditions with ambient temperature above 5°C.

No precipitation shall be falling.

Wind speeds shall be below 22mph (approx. 10m/s) to minimise the effect of wind on bus speed. In case of wind speeds above 11mph (approx. 5m/s) during test, the validity of the test is decided at the discretion of the TS using the OEM predicted performance.

7 Pre-test submissions

It is necessary for the TS to understand details of and make certain additions to the ISA system being tested. Therefore the following documentation shall be provided by the OEM prior to any testing:

- a) Full identification of the ISA system hardware and software versions, and the applicable model of bus
- b) A test vehicle with an indicator system (visible to the bus driver) that displays the maximum speed limit of the ISA system when in Restricted Operating Mode (ROM)
- c) Evidence from an appropriately certified body that the system has been tested and approved as per the requirements for Speedometer equipment within UN ECE Regulation 39
- d) A statement describing how the ISA system operates
- e) A written declaration that this ISA system does not have adverse effects on fuel consumption or emissions



- f) A statement regarding any relevant Type Approvals which apply to the ISA solution. If Type Approvals are not required then a statement of this shall be provided
- g) A description of the applicable iBus system type (1 or 2) and a schematic diagram of the GPS antenna connection to the ISA system
- h) Detail of London Buses' approval for use of the Radio Frequency splitter (if used)
- i) A schematic diagram and description of where the ISA system obtains the vehicle speed information
- j) A demonstration of the receipt of a speed signal from either the FMS or CAN to the ISA system
- k) A statement confirming for which option the ISA is specified from either:
 - i. Option 1 – No intervention by any vehicle system to enforce a speed reduction
 - ii. Option 2 – No intervention by the brakes to enforce a speed restriction, however energy recovery and engine retardation is permitted
- l) A statement as to whether speed restriction is assisted by any system, and a description of the operation of this system
- m) A statement as to whether a function that provides an over-speed notification to the bus driver is fitted, and provide details of the form of this notification
- n) A statement that the vehicle performance characteristics are unaffected when the vehicle is not in Restricted Operating Mode
- o) Instructions regarding how the ISA system is enabled and disabled
- p) It is the responsibility of the test requester to ensure any vehicle tested for ISA provides a method to allow for the GPS, FMS and CAN signals received by the ISA system to be independently isolated. Modification of the relevant vehicle systems and/or cables may be allowed to provide this function during testing.
- q) A description of potential failure modes of the ISA system.
- r) A description of all mapping formats from the file format list provided in the London Bus Technical Specification which can be used on the ISA system.
- s) A statement regarding how any bus mapping can be updated on an ad-hoc basis.
- t) Instructions with/in the application for the updating of the Digital Speed Map, and include any equipment necessary to facilitate this updating for the test. It is the OEM's responsibility to ensure the correct digital map is uploaded prior to test. Two maps shall be provided, with different zones and speed limits as agreed with the test service. These may include one map for the off-road test track and another map for the on-road tests. This shall also include the description of how the map update is protected from unauthorised access.
- u) A declaration regarding any additional antenna for updating the digital speed map.



- v) Instructions and any necessary equipment to read and clear any ISA system fault. A list of possible faults and their codes shall be provided and guidance on how to trigger these faults.
- w) A photo of the ISA symbol as shown on the driver information screen.
- x) A photo of the speed limit symbol as shown on the driver information screen.
- y) A record shall be made of the method provided to inform the driver of ISA fitment. This may be by a photograph for visual methods such as a sticker or light, or by video recording for audio method such as a voice recording.

8 System checks

A number of checks should be made by the Test Service whilst the vehicle is static. Support to achieve the following checks may be provided by the OEM or ISA system supplier where appropriate:

- a) The TS shall physically observe a cabled connection from the GPS antenna to the ISA system. The test shall be deemed to have failed if this cabled connection cannot be observed.
- b) Any speed retardation system declared by the OEM shall be investigated and observed by the TS.
- c) The TS shall enable and disable the system using the instructions provided by the OEM.
- d) The TS shall look for and attempt to non-destructively disable the system in those areas of the VUT accessible to the driver within a period of 2 minutes without tools. The system shall be deemed to fail this requirement if the ISA system can be disabled without tools within a 2 minute period.
- e) The TS shall observe if the following dash lamps are fitted:
 - i. Green – The system is functioning correctly within the Digital Speed Map area
 - ii. White – The vehicle is not within the Digital Speed Map area
 - iii. Amber – The ISA system has a fault.

The system shall be deemed to have failed unless all the dash lamps are fitted. Each lamp may be in the same position and simply change colour as relevant, with the fault warning taking precedence.

- f) The TS shall, if possible, trigger an ISA system fault. The illumination status of the green, white, and amber dash lamps shall be recorded. The system shall be deemed to have failed if the green lamp is not extinguished and the amber lamp is not illuminated when a system fault is caused.
- g) The TS shall interrogate the ISA system for the fault and record if it matches the caused fault. The system shall be deemed to have failed if the system fault recorded does not match the system fault caused. The OEM is responsible for providing a CANbus database file for the ISA system that details system states and faults.



- h) The ISA system supplier or OEM shall provide the TS with method to clear the fault from the system. Fault shall be cleared and the illumination status of the amber light observed. The system shall be deemed to have failed if the system cannot be cleared and if the amber light does not extinguish.
- i) The TS shall review all mapping formats successfully load and correctly function by driving the vehicle on the off-road test track and testing for the correct application of 20mph and 30mph speed limits. The test shall be deemed to have failed if this information is not provided. The test shall be deemed to have failed if these mapping formats fail to properly load and apply.
- j) The TS shall observe that any outdated Digital Speed Map can be completely removed from the ISA system and replaced with an updated map. This test may require a computer connection to the ISA system to check upon file deletion and addition, and the system shall be deemed to have failed if outdated Digital Speed Maps cannot be completely removed.
- k) The TS shall assess an ad-hoc change to the Digital Speed Map. The system shall be deemed to have failed if in the assessment of the TS the bus Digital Speed Map cannot be updated on an ad-hoc basis.
- l) Addition of a specific antenna for updating the Digital Speed Map is prohibited. The presence of such an antenna shall result in test failure.

9 Test procedure

The vehicle speed for each test shall be measured and recorded from the vehicle CAN. This measurement shall be used for all assessments and comparison to Target Speed and Speed limits. The CAN speed shall comply with the accuracy requirements of UN ECE Regulation 39 and shall be reflected on the Speedometer.

Note: A check should be performed before starting each defined test to ensure the ISA is in the correct enabled/disabled condition applicable for the relevant test.

9.1 Track testing

The following tests shall be undertaken at a suitable test track (see Section 6.1).

Where reasonable and appropriate the test service may assess multiple functions at the same time whilst still conforming to the procedures defined in this document. This may be conducted at the discretion of the test service, with prior agreement from the Approval Authority.

The VUT shall be driven on a test track whereby separate areas of the track are entered into the VUT's Digital Speed Map with speed limits of; 20mph, 30mph, 40mph and unrestricted.

The VUT shall be tested in compliance with the relevant procedures dependant on whether it has been stated by the OEM as conforming to either Option 1 or Option 2 as defined in Section 7 l).

Tests shall be conducted in an unladen condition with a driver (and observer if required).



9.1.1 Option 1 tests

9.1.1.1 Check to assess there shall be no intervention by any vehicle system to enforce a speed reduction.

The VUT shall be driven at a speed of 30mph whilst within a 30mph zone.

It shall enter into a 20mph zone with the accelerator pedal fully depressed and continue travelling with pedal fully depressed, for at least 15 seconds.

The ISA shall not actively reduce the vehicle speed which shall remain stable at 30mph for the duration of the test.

9.1.1.2 Check to assess the ISA will impose the speed restriction of the previous zone until the driver brings the vehicle below the prevailing speed limit

The VUT shall be driven at a speed of 30mph whilst within a 30mph zone.

It shall enter into a 20mph zone with the accelerator pedal fully depressed and continue travelling with pedal fully depressed for at least 15 seconds.

The driver shall reduce the vehicle speed under braking until it is between 22mph and 26mph and then accelerate with the accelerator pedal fully depressed.

Upon achieving 30mph the VUT shall continue travelling with the pedal fully depressed, for at least 15 seconds.

The ISA shall prevent the vehicle speed from exceeding the speed limit of 30mph.

9.1.1.3 Check to assess when the vehicle speed drops below the prevailing speed limit the ISA shall actively prevent the limits from being exceeded

The VUT shall be driven at a speed of 30mph whilst within a 30mph zone.

It shall enter into a 20mph zone with the accelerator pedal fully depressed and continue travelling with pedal fully depressed for at least 15 seconds.

The driver shall reduce the vehicle speed under braking until it is between 12mph and 16mph and then accelerate with the accelerator pedal fully depressed.

Upon achieving 20mph the VUT shall continue travelling with the pedal fully depressed, for at least 15 seconds

The ISA shall prevent the vehicle speed from exceeding the speed limit of 20mph.

9.1.1.4 Check to confirm that any vehicle speed in excess of the prevailing limit should be notified to the driver via a flashing speed limit symbol.

The VUT shall be driven at a speed of 30mph whilst within a 30mph zone.

It shall enter into a 20mph zone with the accelerator pedal fully depressed and continue travelling with pedal fully depressed for at least 15 seconds.

Whilst the vehicle speed is in excess of zone speed limit the driver shall be notified via a flashing speed limit symbol

The flashing frequency of the speed limit symbol shall be between 1Hz and 5Hz



9.1.2 Option 2 tests

9.1.2.1 Check ISA will impose a speed restriction as soon as all conditions of ROM are met.

The VUT shall be driven at a speed of 30mph whilst within a 30mph zone.

It shall enter into a 20mph zone with the accelerator pedal fully depressed and continue travelling with pedal fully depressed.

After entering the 20mph zone the ISA shall actively reduce the speed of the VUT in the manner described by the vehicle OEM.

9.1.2.2 Check of ISA that vehicle speed reduction has been achieved without intervention of braking.

Note: Deceleration produced by energy recovery and/or engine retardation up to the level of 0.15m/s^2 .

The VUT shall be driven at a speed of 30mph whilst within a 30mph zone.

It shall enter into a 20mph zone with the accelerator pedal fully depressed and continue travelling with pedal fully depressed.

After entering the 20mph zone the ISA shall actively reduce the speed of the VUT in the manner described by the vehicle OEM.

The VUT shall continue travelling with accelerator pedal fully depressed until vehicle speed remains stable at 20mph [$+0$ -2mph] for the duration of at least 15 seconds.

9.1.2.3 Check of driver notification should ISA enforce any retardation of vehicle speed.

The VUT shall be driven at a speed of 30mph whilst within a 30mph zone.

It shall enter into a 20mph zone with the accelerator pedal fully depressed and continue travelling with pedal fully depressed for at least 15 seconds.

After entering the 20mph zone the ISA shall actively reduce the speed of the VUT in the manner described by the vehicle OEM.

Whilst the VUT is travelling in excess of zone speed limit and the ISA system is actively retarding the vehicle speed, the driver shall be notified. This may be via a flashing speed limit symbol and by a reduction in the indicated speed.

The flashing frequency of the speed limit symbol shall be between 1Hz and 5Hz

9.1.3 Other tests

Whether conforming to either Option 1 or Option 2, the VUT shall be tested to the following procedures.

9.1.3.1 Check that the ISA system does not affect the operation of the VUT below the speed limit.

- a) The VUT shall be accelerated at full rate from 0mph within a 20mph zone.

The time taken to reach a vehicle speed of 16mph (equivalent to 80% of the zone's speed limit), shall be measured and recorded.



The ISA system shall then be disabled and the time taken to accelerate to the same speed shall be measured and recorded for the same section of track. (ISA system should be enabled after completing this measurement).

The system shall be deemed to have failed if the difference in times to accelerate to same vehicle speed (80% of the zone's speed limit) with and without the ISA activated is more than 10%.

This shall then be repeated within a 30mph zone measuring the time taken to achieve a vehicle speed of 24mph (80% of the zone's speed limit).

- b) The VUT shall be driven within a 20mph zone with the accelerator pedal fully depressed. The VUT shall be travelling at a constant 20mph limit.

It shall enter into a 30mph zone with the accelerator pedal fully depressed and continue travelling with pedal fully depressed, for at least 15 seconds.

The system shall be deemed to have failed if the measured VUT acceleration is greater than 1.2m/s^2 .

This shall then be repeated starting within a 30mph zone and entering into an unrestricted zone.

9.1.3.2 Check that the system is secure from tampering.

- a) It shall be possible for only qualified personnel to disable the speed limiting system and only when the ignition is on and the vehicle is stationary.
- b) The disabling of the system must be via an electronic device (e.g laptop, tablet or similar) connected to the vehicle. Additional control using a telematics system to manage the fleet is optional. The system shall be deemed to have failed if the conditions of the test cannot be met and if it would be possible for unequipped/unauthorised disabling of the system.
- c) The TS shall check for the correct enabling and disabling of the ISA system by test driving the VUT in both conditions. The system shall be deemed to have failed if the ISA system does not properly enable or disable.

9.1.3.3 Check that in the event of loss of GPS signal the system will fail safe whereby no speed limits are implemented by the ISA system.

- a) The VUT shall be driven at a speed of 20mph whilst within a 20mph zone, with the accelerator pedal fully depressed for the duration of the test.

The GPS shall be isolated, see Section 7 q) replicate a signal loss and the vehicle speed shall be observed for 15 seconds and recorded.

The system shall be deemed to have failed if the VUT is recorded as reaching speeds above 20mph.

- b) The VUT shall be driven at a speed of 20mph whilst within a 20mph zone, with the accelerator pedal fully depressed, for at least 15 seconds.

The driver shall apply the brakes to reach a vehicle speed of 14mph or less, before accelerating to a speed above 20mph.

The system shall be deemed to have failed if the VUT fails to reach speeds above 20mph.



- c) Tests shall be repeated with the FMS isolated.
- d) Tests shall be repeated with the CAN isolated.

9.1.3.4 **Check of the travelled distance before a change of the speed limit indicator when entering a speed limit zone. (Guard against spurious GPS inaccuracy)**

- a) The VUT shall be driven at a speed of between 5mph and 12mph whilst within a 20mph zone.

It shall enter into a 30mph zone whilst retaining the same vehicle speed.

Using the front of the bus as the reference point, the distance travelled within the 30mph zone before the indicator system displays the new speed limit shall be recorded in metres.

The system shall be deemed to have failed if the distance recorded less than 30.0m

- b) This test shall be repeated with the VUT travelling at a speed of between 5mph and 12mph whilst within a 30mph zone and entering into a 20mph zone.

9.1.3.5 **Check of the time to indicate VUT having entered a ROM zone (Guard against spurious GPS inaccuracy)**

- a) The VUT shall be driven at a speed of 20mph whilst within a 20mph zone for a time of at least 15seconds.

It shall enter into a 30mph zone whilst retaining the same vehicle speed.

The time taken once within the 30mph zone before the indicator system displays the new speed limit shall be recorded.

The system shall be deemed to have failed if the time recorded is less than 5.0seconds and greater than 8.0second.

- b) This test shall be repeated with the VUT travelling at 30mph whilst within a 30mph zone and entering into a 20mph zone.

9.1.3.6 **Check the indication that the VUT has entered or exited the digital map area**

- a) The VUT shall be driven at a speed of 20mph from outside of the Digital Map Area for a time of at least 15 seconds

It shall enter into the Digital Map Area.

The time and the distance travelled before the dash lamp displays that the VUT has entered the Digital Map Area shall be recorded.

The system shall be deemed to have failed if the time recorded is less than 5.0seconds and greater than 8.0seconds ($5 < t < 8$) OR the distance travelled was less than 30.0m.

- b) This test shall be repeated with the VUT travelling from inside the Digital Map Area and exiting it.



9.1.3.7 Check of the continuous illumination of the green dash lamp

- a) The VUT shall be driven at a speed of 20mph whilst within a 20mph zone with the accelerator pedal fully depressed, for a time of at least 15 seconds.

It shall enter into a 30mph zone continue to travel with the accelerator pedal fully depressed for a distance of at least 100m.

The illumination status of the green dash lamp shall be recorded.

The system shall be deemed to have failed if the continuous green lamp extinguishes during the test.

- b) This test shall be repeated with the VUT travelling from a 30mph zone into a 20mph zone.

9.1.3.8 Check for failure indication of GPS, FMS and CAN

- a) The VUT shall be driven at a speed of 20mph whilst within a 20mph zone for a time of at least 15 seconds

The GPS isolator switch shall be operated to replicate signal loss.

The time and distance taken before the green ISA lamp is extinguished and the white dash lamp illuminate shall be recorded.

The system shall be deemed to have failed if the time recorded is less than 5.0seconds and greater than 8.0seconds ($5 < t < 8$) OR the distance travelled was less than 30.0m.

- b) Test shall be repeated using the FMS isolator switch.
c) Test shall be repeated using the CAN isolator switch.

9.1.3.9 Check for indication of VUT being outside of the Digital Map Area

Whilst outside of the Digital Map Area by a distance of greater than 100m the vehicle shall be started and driven. The VUT shall remain outside of the Digital Map area and complete at least 100m travel.

The status of the dash lamps indicating ISA status shall be recorded.

The ISA system shall be deemed to have failed if the green lamp is not extinguished AND the white lamp is not illuminated at all times.

9.1.3.10 Check for dash indication with ISA system disabled

Whilst outside of the Digital Map Area the ISA system shall be disabled.

The VUT shall then be driven into the Digital Map Area by for a distance of at least 100m and then driven at least 100m out of the Digital Map Area.

The status of the green and white dash lamps shall be recorded.

The ISA system shall be deemed to have failed if at any time the green lamp is illuminated OR the white lamp is extinguished.



9.1.3.11 Check “No Digital Speed Map” condition

The TS shall ensure that when there is no Digital Speed Map loaded on to the VUT there is no system activation and no speed restriction exists.

The ISA system shall be deemed to have failed if a speed restriction is found on a bus with no Digital Speed Map loaded on to the system.

9.1.3.12 Check VUT restricted speeds against Digital Speed Map speed limits

- a) The TS shall ensure the maximum vehicle speeds achievable whilst within each zone are the same as the speeds limits defined in the Digital Speed Map

The VUT shall be deemed to have failed if the maximum vehicle speed achievable for any zone is found to be different to those expected from the loaded map.

- b) Test to be repeated using an alternative Digital Speed Map which consists of different zones and limits to ensure the speed restrictions have subsequently changed

Note: It may be useful to ensure that the zones and speed limits are clearly mapped against features/markers.

9.2 On road testing

On road testing shall only be commenced upon successfully achieving all requirements defined for track testing.

The VUT shall be driven on the on road testing infrastructure as defined in Section 6.1

Tests shall be conducted in an unladen condition with a driver (and observer if required).

Note: The TS shall pre-determine a route for this test. It is prudent to choose times of day when the speed limits may be reached, and which limit risk (for example times when vulnerable children are less likely to be present).

Note: The TS shall create a printed map of the route using speed limit information from the applicable Digital Speed Map to allow test observer who is not the driver to cross reference actual location to the Digital Speed Map and the maximum speed limit indicator.

Note: The TS shall record the route using a separate GPS system and use a map of the route to assist with identifying each part of the test.

Note: A duplex video camera system, with one view of the speedometer and the other of the road ahead can assist in determining speed, location, and speed exceedances. Video is to be time aligned during test to speed and position data within the TS data acquisition software.

9.2.1 Check VUT restricted speeds against Digital Speed Map speed limits

The TS shall ensure the maximum vehicle speed achievable whilst within each zone are the same as the speed limit defined in the Digital Speed Map



The VUT shall be deemed to have failed if the maximum vehicle speed achievable for any zone is found to be different to those expected from the loaded map.

Note: Speed limit shall only be achieved when and where safe to do so.

9.2.2 **Check of the travelled distance and time before a change of the speed limit indicator when entering a speed limit zone**

A visual comparison of the digital speed limit map and the speed limit indicator shall be made as the VUT enters each speed limit zone.

The system shall be deemed to have failed if the time recorded is less than 5.0 seconds and greater than 8.0seconds ($5 < t < 8$) OR the distance travelled was less than 30.0m.

9.2.3 **Check ISA will impose a speed restriction as soon as all conditions of ROM are met**

Whilst the VUT is within a zone and has at any point travelled at a speed less than the speed limit, the ISA system will be expected to prevent the vehicle from exceeding the speed limit.

The system shall be deemed to have failed if the VUT exceeds the zone speed limit by greater than 2mph. Note: This shall not apply where the VUT is travelling downhill.

10 **Assessment of results**

The following criteria will be used to assess if the ISA system has passed or failed the assessment.

10.1 **Pre-test submissions**

In order to receive a “Pass” certification the system must receive a “Pass” grade for each of the requirements on the assessment checklist.

The system shall be deemed to have failed the assessment if it received a single “Fail” grade on the pre-test submissions checklist.

10.2 **System checks**

In order to receive a “Pass” certification the system must receive a “Pass” grade for each of the requirements on the assessment checklist.

The system shall be deemed to have failed the assessment if it received a single “Fail” grade on the system checks checklist.

10.3 **Track tests**

In order to receive a “Pass” certification the system must receive a “Pass” grade for each of the requirements on the assessment checklist.

The system shall be deemed to have failed the assessment if it received a single “Fail” grade on the track testing checklist.



10.4 On-road tests

In order to receive a “Pass” certification the system must receive a “Pass” grade for each of the requirements on the assessment checklist.

The system shall be deemed to have failed the assessment if it received a single “Fail” grade on the on-road testing checklist.

10.5 Overall Assessment

In order to receive an overall “Pass” certification the ISA system must receive a “Pass” grade for each of the above sections on the checklists

The system shall receive an overall “Fail” grade in the assessment if a single “Fail” grade was awarded on any section of the assessment checklists.

To integrate this pass/fail test into the overall bus safety score an overall Pass will be deemed as a score of 100% and a fail will be deemed a score of 0%

11 Test Report

The TS shall provide a comprehensive test report that will be made available to the AA. The test report shall consist of six distinct sections:

- a) Completed pre-test submissions checklist
- b) Completed system checks checklist
- c) Completed track tests checklist
- d) Completed on-road tests checklist
- e) Confirmation of protocol compliance against the specified performance requirement (option 1 or option 2)
- f) Reference information

The reference information required includes as a minimum:

- a) Vehicle make
- b) Vehicle model
- c) Vehicle model variant
- d) ISA Hardware version
- e) ISA Software version
- f) iBus version (1 or 2)
- g) ISA Option (1 or 2)
- h) Applicable mapping types
- i) Details of the TS
- j) Test date(s)





Appendix A - Pre-test submissions checklist

Details found in Section 7.

	Pre-test submissions	Pass/Fail
1	Full identification of the ISA system hardware and software versions, and the applicable model of bus provided by the bus OEM.	
2	A test vehicle provided by the bus OEM with an indicator system (visible to the bus driver) that displays the maximum speed limit of the ISA system when in restricted operating mode.	
4	A statement provided by the bus OEM describing how the ISA system operates.	
5	A written declaration provided by the bus OEM that this ISA system does not have adverse effects on fuel consumption or emissions.	
6	A statement provided by the bus OEM regarding any relevant type approvals which apply to the ISA solution. If type approvals are not required then a statement of this shall be provided.	
7	A description provided by the bus OEM of the applicable iBus system type (1 or 2) and a schematic diagram of the GPS antenna connection to the ISA system.	
8	Detail of London Buses' approval for use of the Radio Frequency splitter (if used) used as part of the ISA system.	
9	A schematic diagram and description of where the ISA system obtains the vehicle speed information, provided by the bus OEM.	
10	A physical demonstration of the receipt of a speed signal from either the FMS or CAN to the ISA system, provided by the bus OEM	
11	A statement has been provided by the bus OEM in their application confirming which option is chosen from either: Option 1 – No intervention by any vehicle system to enforce a speed reduction Option 2 – No intervention by the brakes to enforce a speed restriction, however energy recovery and engine retardation is permitted.	
12	A statement has been provided by the bus OEM of if speed restriction is assisted by any system, and to describe the operation of this system.	
13	A statement has been provided by the bus OEM of if an over-speed notification to the bus driver function is fitted, and provide details of the form of this notification.	
14	A statement has been provided by the bus OEM that the vehicle performance characteristics are unaffected when the vehicle is not in restricted operating mode.	
15	Instructions are provided by the bus OEM regarding how the ISA system is enabled and disabled.	
16	The bus OEM has provided a test vehicle where the GPS, FMS and CAN speed signals in to the ISA system can be independently isolated. Included must be clarification of how this has been achieve and how to isolate each signal.	
17	The bus OEM has provided a description of potential failure modes of the ISA system.	
18	The bus OEM has provided a description of all mapping formats from the list which can be used on the ISA system.	
19	The bus OEM has provided a statement regarding how any bus mapping can be updated on an ad-hoc basis.	



	Pre-test submissions	Pass/Fail
20	<p>The bus OEM has provided adequate instructions with/in the application for the updating of the digital speed map, and include any equipment necessary to facilitate this updating for the test. This shall also include the description of how the map update is protected from unauthorised access.</p> <p>Two off-road test track-specific maps shall be provided, with different zones and speed limits as agreed with the test body.</p>	
21	<p>The bus OEM has provided a declaration in their application regarding any additional antenna for updating the digital speed map.</p>	
22	<p>The bus OEM has provided instructions and any necessary equipment to read and clear any ISA system fault. A list of possible faults and their codes shall be provided and guidance on how to trigger these faults.</p>	
23	<p>A photo of the ISA symbol as shown on the driver information screen.</p>	
24	<p>A photo of the speed limit symbol as shown on the driver information screen.</p>	
25	<p>A copy of the ISA fitment information to the driver (sticker, light, voice instruction etc), in a suitable format.</p>	

Result:



Appendix B - System checks.

Details found in Section 8.

	System Checks	Pass/Fail
1	The cabled connection from the GPS antenna to the ISA system can be observed.	
2	If a speed retardation system was declared by the bus OEM, then it was investigated and observed by the test service.	
3	The system can be enabled and disabled by using the instructions provided by the Bus OEM.	
4	The ISA system could not be non-destructively disabled without tools within a 2 minute period.	
5	The green dash lamp, white dash lamp and an amber dash lamp are all fitted for the ISA System.	
6	A triggered ISA system failure caused the green lamp to extinguish and the amber lamps were illuminated.	
7	Interrogation of the ISA system for the fault found a match to the caused fault.	
8	The fault can be cleared from the system.	
	The amber light was extinguished when the fault was cleared.	
9	The mapping format loaded and applied properly.	
	The correct application of 20mph and 30mph speed limits with applicable mapping formats was observed.	
10	The outdated Digital Speed Map can be completely removed from the ISA system.	
	A new map can be uploaded properly.	
11	An ad-hoc change to the Digital Speed Map can be properly uploaded.	
12	No additional antenna for updating the Digital Speed Map is found.	

Result:



Appendix C - Track testing checklist

Details found in Section 9.

Type of intervention option selected:

		Track testing	Pass/Fail
Option 1 tests	1	Check to assess no intervention by any vehicle system to enforce speed reduction	
	2	Check to assess the ISA will impose the speed restriction of the previous zone until the driver brings the vehicle below the prevailing speed limit	
	3	Check to assess when the vehicle speed drops below the prevailing speed limit the ISA shall actively prevent the limits from being exceeded	
	4	Check to confirm that any vehicle speed in excess of the prevailing limit should be notified to the driver via a flashing speed limit symbol.	
Option 2 tests	1	Check ISA will impose a speed restriction as soon as all conditions of ROM are met	
	2	Check of ISA that vehicle speed reduction has been achieved without intervention of braking.	
	3	Check of driver notification should ISA enforce any retardation of vehicle speed.	
Other tests	1	Check that the ISA system does not affect the operation of the VUT below the speed limit.	
	2	Check that the system is secure from tampering	
	3	Check that in the event of loss of GPS signal the system will fail safe whereby no speed limits are implemented by the ISA system	
	4	Check of the travelled distance before a change of the speed limit indicator when entering a speed limit zone. (Guard against spurious GPS inaccuracy)	
	5	Check of the time to indicate VUT having entered a ROM zone (Guard against spurious GPS inaccuracy)	
	6	Check the indication that the VUT has entered or exited the digital map area	



		Track testing	Pass/Fail
	7	Check of the continuous illumination of the green dash lamp	
	8	Check for failure indication of GPS, FMS and CAN	
	9	Check for indication of VUT being outside of the Digital Map Area	
	10	Check for dash indication with ISA system disabled	
	11	Check "No Digital Speed Map" condition	
	12	Check VUT restricted speeds against Digital Speed Map speed limits	

Result:



Appendix D - On-road testing checklist

	On road testing	Pass/Fail
1	Check VUT restricted speeds against Digital Speed Map speed limits	
2	Check of the travelled distance and time before a change of the speed limit indicator when entering a speed limit zone	
3	Check ISA will impose a speed restriction as soon as all conditions of ROM are met	

Result:



Attachment 18: Intelligent Speed Assistance (ISA) Guidance Notes

1 Introduction

This document sets out the guidance notes related to Intelligent Speed Assistance. This system provides an aid to the driver, limiting the vehicle speed whilst travelling in designated speed limit zones.

These guidance notes are aimed at bus operators and manufacturers as a practical guide for implementation of the Bus Safety Standard.

These notes are for guidance only, and are not legally binding. In all circumstances, the guidance provided by a manufacturer of the bus or system shall take precedence, and these guidance notes are only for use in the absence of other information. These are not intended to be exhaustive, but to point the operators toward practical advice and questions to raise with manufacturers/suppliers.

1.1 ISA Description

Intelligent Speed Assistance (ISA) is a system fitted to buses which links an understanding of location (from GPS¹) to an on-board map of speed limits (known as the Digital Speed Map), and a reading of the bus speed. It uses this information to limit the speed of the bus and at present it does this in two options:

- Option 1: No intervention by any vehicle system to enforce a speed reduction
- Option 2: No intervention by the brakes to enforce a speed restriction, however energy recovery and engine retardation is permitted.

The Digital Speed Map will be created and updated by Transport for London, and it will be the responsibility of the bus operator to update the maps in buses either on a periodic timeline, or if directed an emergency timeline. It is advised that the bus operator keeps records of the date and version number of any uploaded Digital Speed Map against each bus.

Vehicles fitted with ISA can exceed the speed limit, for example in locations where gravity (typically downhill) will allow the bus to exceed the speed limit, or where the bus enters a lower speed limit. It is also likely in some circumstances for there to be a time lag between the implementation of a speed limit and the updating of the Digital Speed Map, and this is certainly likely to be the case for temporary speed restrictions such as roadworks.

Driving at the speed limit is not always appropriate for the road curvature, surface, traffic, environmental conditions etc. The driver is responsible for the vehicle speed and compliance with road speed limits at all times. ISA does not absolve the driver of responsibility for remaining within the speed limit.

¹ GPS = Global Positioning System. GPS is a global navigation satellite system that provides geolocation and time information to a GPS receiver anywhere on or near the Earth where there is an unobstructed line of sight to four or more GPS satellites. It allows the position of the bus to be identified in real time.



Below the speed limit the ISA has no impact upon the speed, acceleration, or any other operation of the bus.

When entering a lower speed limit it is the driver's responsibility to reduce the vehicle speed. The ISA will not brake. If the driver keeps their foot on the accelerator pedal speed will not be forced to reduce by any vehicle system.

When entering a higher speed limit the vehicle will not increase speed automatically. Speed will only increase in response to the level of pressure on the accelerator pedal. It is the driver's responsibility to accelerate safely and only when conditions are appropriate.

The system cannot anticipate speed changes. For example it will not begin slowing down in advance of a lower speed limit sign.

2 Selection of buses/systems

ISA can be fitted on new-build buses, conforming with either of the two options specified.

A further variation can be the retrofit of ISA to in-service vehicles in some circumstances. The use of aftermarket equipment is authorised on the condition if it is a vehicle OEM integrated solution and complies with all performance requirements of the ISA specification prior to the homologation process. Only with express written approval from the Approval Authority within TfL, in the instance where an OEM has confirmed they have no intent to fit or support retrofit, will the use of aftermarket equipment be allowed.

It is anticipated that a future version of iBus provided by TfL will integrate ISA, so this is worth considering when selecting a supplier.

3 Training

3.1 Driver training

Training of drivers should entail at least the following elements:

- How the bus will operate
- How to understand the various warning lights
- What happens when transitioning between speed limits
- Limitations of the system, operating limits
- Clear emphasis that the driver remains responsible for speed limit compliance at all times.

The ISA supplier should provide specific material or advice which is appropriate to the system.

3.2 Maintenance training



It is expected that the bus operator will update the Digital Speed Map on each bus, and if this is the case then bus operator staff should be suitably trained to do so.

It is envisaged that the ISA supplier/Bus supplier will offer suitable maintenance training, covering at a minimum; map updating, and enabling and disabling the system. Additionally and depending upon any warranty and maintenance agreement, training may extend to fault finding/repair.

4 Maintenance

The ISA systems are specified so that they may not be easily interfered with by the driver. The bus driver is not expected to undertake any maintenance.

The bus operators and the ISA supplier/Bus supplier will reach an agreement regarding responsibility for ISA system maintenance and repair, and that any personnel undertaking maintenance are suitably trained and have access to any relevant documentation (such as schematics, fault-finding, parts lists, fitment details).

Suitably trained and authorised persons (who are not the driver) within the bus operator will be able to disable the ISA system if required, and should be provided with any relevant tools or software/hardware to enable this.



Attachment 19: Bus Vision Standard

Assessment Protocol

1 Introduction

This document presents a procedure, hereon referred to as the Bus Vision Standard (BVS), for objectively measuring the vision that the driver has of the environment in close proximity to a bus, both directly via the windows/windscreen and indirectly via mirrors and/or camera-monitor systems (CMS).

For full understanding of this Attachment it should be read in conjunction with the Attachment 20: Bus Vision Standard Guidance Notes and New Bus Specification, Section 4.3.7.

1.1 Scope

This protocol applies to all new buses intended for service under contract to TfL that are passenger vehicles with a maximum mass exceeding 5 tonnes and a capacity exceeding 22 passengers. The passenger vehicles will be capable of carrying seated but unrestrained occupants and standing occupants. Such vehicles are categorised in the Consolidated Resolution on the Construction of Vehicles (R.E.3) as M₃; Class I, Class II.

1.2 Purpose

The aim of the Bus Vision Standard (BVS) assessment protocol is to provide an objective assessment that can be used to quantify the vision performance of a bus, enforce minimum standards and encourage performance over and above these minimum standards, while still permitting beneficial innovations (e.g. replacing mirrors with camera-monitor systems (CMS)) without adversely affecting safety.

Over many years blind spots in a driver's vision have been identified as a contributory factor in collisions between vehicles and pedestrians and cyclists which resulted in death or seriously injury. The BVS has been defined to reduce likelihood of these type of collisions.

Typically, direct vision blind spots in buses are caused by the A-pillars of the bus, the pillars around and at the centre of the front doors, the driver assault screen and by equipment in the driver cabin. Indirect vision areas rear of the driver seat position and for wider fields of view may also be subject to blind spots

It should be noted that the BVS is designed around collision situations relating to low speed, close proximity manoeuvres. It does not assess the vision required for higher speed manoeuvres and so scoring well does not absolve the OEM from the responsibility to design appropriate vision for all circumstances.



2 Normative References

The following normative documents, in whole or in part, are referenced in this document and are indispensable for its correct application. For dated references, only the edition cited applies. For undated references, the latest edition of the referenced document (including any amendments) applies.

- London Bus Services Limited New Bus Specification: Section 4.3.7
- London Bus Services Limited New Bus Specification: Attachment 20 Bus Vision Standard Guidance Notes
- Directive 2007/46/EC of the European Parliament and of the Council establishing a framework for the approval of motor vehicles and their trailers, and of systems, components and separate technical units intended for such vehicles.
- European Tyre and Rim Technical Organisation (ETRTO) Standards Manual
- Regulation (EU) 2018/858 of the European Parliament and of the Council of 30th May 2018 on the approval and market surveillance of motor vehicles and their trailers, and of systems, components and separate technical units intended for such vehicles, amending Regulations (EC) No 715/2007 and (EC) No 595/2009 and repealing Directive 2007/46/EC.
- SAE J182 (2015) "Motor Vehicle Fiducial Marks and Three-dimensional Reference System".
- SAE J1100 (2009) "Motor Vehicle Dimensions".
- SAE J1516 (2011) "Accommodation Tool Reference Point for Class B Vehicles".
- SAE J1517 (2011) "Driver Selected Seat Position for Class B Vehicles - Seat Track Length and SgRP".
- UN ECE Regulation 107 Uniform provisions concerning the approval of category M₂ or M₃ vehicles with regard to their general construction.
- UN ECE Regulation 46 Uniform provisions concerning the approval of devices for indirect vision and of motor vehicles with regard to the installation of these devices.

3 Definitions

For the purpose of this Protocol:

- **Accelerator Heel Point (AHP)** - A point on the shoe located at the intersection of the heel of shoe and the depressed floor covering, when the shoe tool is properly positioned. (Essentially, with the ball of the foot contacting the lateral centre line of the undepressed accelerator pedal, while the bottom of the shoe is maintained on the pedal plane). As defined in SAE J1516, SAE J1517 and SAE J1100.
- **AHP height** - Vertical height in the Z axis between the ground plane and AHP.



- **Ambinocular vision** - The total combined field of view that can be seen by at least one eye.
- **Angle of incidence** - The angle which a sightline makes with a plane that is angled perpendicular to the surface at the obstruction point. At the point where a sightline intersects a surface (Obstruction point), the angle between the sightline and a plane perpendicular to the surface at the Obstruction point
- **Approval Authority** - The body within TfL that certifies that a bus is approved for use in the TfL fleet and assigns its score under the bus safety standard for use in procurement processes.
- **Assessment zone** - The volume around the vehicle under test defining the volume of space that needs to be seen by the driver in order to view vulnerable road users within the area of greatest risk. The assessment zone is defined by collision data and by the UN ECE Regulation 46 indirect field of vision requirements.
- **Assessment zone element** - An element of known volume, and with no single dimension exceeding [0.1]m, that forms part of the overall assessment zone volume.
- **Blind spot** - A blind spot is a volume of space around the vehicle under test that cannot be seen by a driver either through the daylight opening (DLO) or through the indirect vision devices installed on the vehicle.
- **Blind spot volume** - The proportion of the assessment zone that cannot be seen by the driver through either the direct or indirect fields of view.
- **Bus vision standard performance score** - The proportion of each assessment zone visible to the driver through the direct field of view.
- **Camera** - A device that renders an image of the outside world and converts this image into a signal (e.g. video signal).
- **Camera point** - A point representing the origin of the field of view of a camera.
- **Camera-monitor system (CMS)** - An indirect vision device where the field of vision is obtained by means of a UN ECE Regulation 46 certified combination of camera and monitor systems.
- **Coordinate system** - The three-dimensional vehicle coordinate system that is established in SAE J182.
- **Daylight opening (DLO)** - An area of a vehicle, windscreen or other glazed surface whose light transmittance measured at right angles to the surface is not less than 70%. As defined in UN ECE Regulation 125.
- **Direct field of view** - The field of view seen without the aid of any additional devices.
- **Direct vision volume** - The proportion of the assessment zone visible to the driver through the direct field of view.
- **Direct vision performance score** - The proportion of each assessment zone visible to the driver through the direct field of view.



- **Eye points (E_L , E_R)** - Two points representing the driver's left and right eyes. These are the points from which sightlines originate.
- **ETRTO** - European Tyre and Rim Technical Organisation.
- **Gross vehicle weight (GVW)** - The maximum permitted mass of a vehicle when fully loaded.
- **Ground plane** - Horizontal plane, parallel to the XY plane, at ground level.
- **Indirect field of view** - The field of view seen through the aid of an additional device such as mirrors or camera-monitor systems (CMS).
- **Indirect vision volume** - The proportion of the assessment zone visible to the driver through the indirect field of view.
- **Indirect vision performance score** - The proportion of each assessment zone visible to the driver through the indirect field of view.
- **Monitor** - A device that converts a signal into images that are rendered into the visual spectrum.
- **Monocular vision** - The total field of view that can be seen by a single eye or camera.
- **Neck pivot point (P)** - Point about which a driver's head turns on a horizontal plane.
- **Obstruction point** - A point located on the vehicle structure that obstructs the driver field of view.
- **OEM: Original Equipment Manufacturer** – The company responsible for the manufacture of a completed bus, delivered to a bus operator
- **Reference eye point (E_{ref})** - Midpoint between left and right eye points at centre line of driver.
- **Reflection point** - A point located on a mirrored surface that reflects the driver field of view.
- **Sightline** - A line representing the driver's line of sight from an eye point to an obstruction point, reflection point or a given angle.
- **Test service** - The organisation undertaking the testing and certification of the results to the Approval Authority.
- **Total driver vision volume** - The proportion of the assessment zone visible to the driver through either the direct or indirect fields of view.
- **Vehicle length** - The distance in the X axis between two points located at the foremost and rearmost aspect of the vehicle structure, excluding all features listed in Appendix A.
- **Vehicle structure** - All relevant vehicle glazing and bodywork, excluding all features listed in Appendix A.
- **Vehicle under test (VUT)** - The vehicle tested according to this protocol.



- **Vehicle width** - The distance in the Y axis between two points located at the most lateral aspects of the vehicle structure coincident to the first axle, excluding all features listed in Appendix A.

4 Test conditions

4.1 Coordinate System

A global coordinate system (X, Y, Z) for the VUT shall be defined such that the X axis is positive toward the front of the vehicle, the Y axis towards the left (nearside) and the Z axis upwards, as shown in Figure .

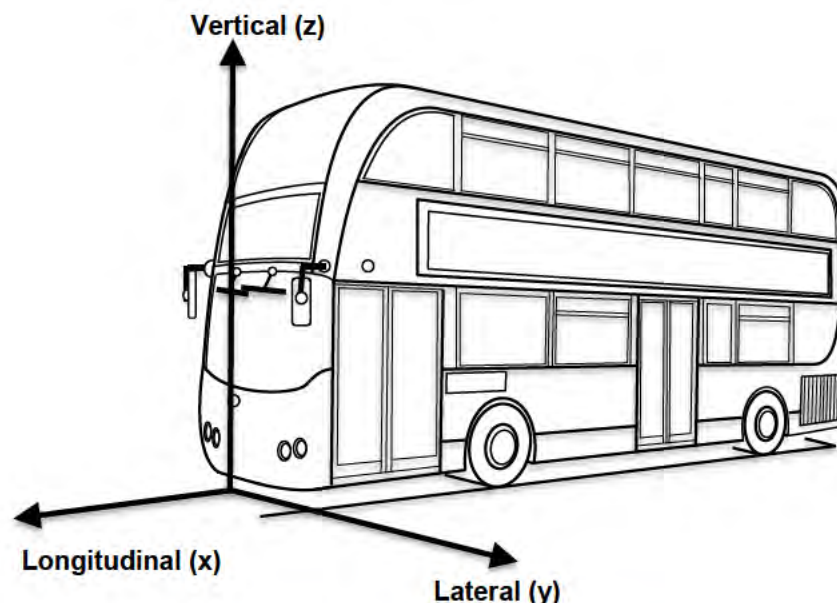

Figure 19_1: Global coordinate system and notation

The origin of the co-ordinate system shall lie on the ground plane, on the lateral centre line of the vehicle at the foremost point of the vehicle structure.

4.2 Eye Points

The field of view of the driver shall be defined by a cyclopean monocular vision point (E_C) taken as the mid-point between two eye points (E_L and E_R). Rotation shall be possible about a neck pivot point (P). E_L , E_R and P locations are defined in relation to the E_{ref} position, which in turn is defined in relation to the AHP.

4.3 Reference Eye Point Location (E_{ref})

The reference eye point (E_{ref}) is defined as an offset from the AHP of [0.678]m in the X axis and [1.16325]m in the Z axis, as shown by Figure19_2. The reference eye point position in the X/Z-axes (E_{ref_x} , E_{ref_z}) shall therefore be positioned relative to the AHP position (AHP_x , AHP_z) according to the following equations:

$$E_{ref_x} = AHP_x + [0.678]m$$

$$E_{ref_z} = AHP_z + [1.16325]m$$

The reference eye point position in the Y axis (E_{ref_y}) shall be located in line with the central plane of the driver seat.

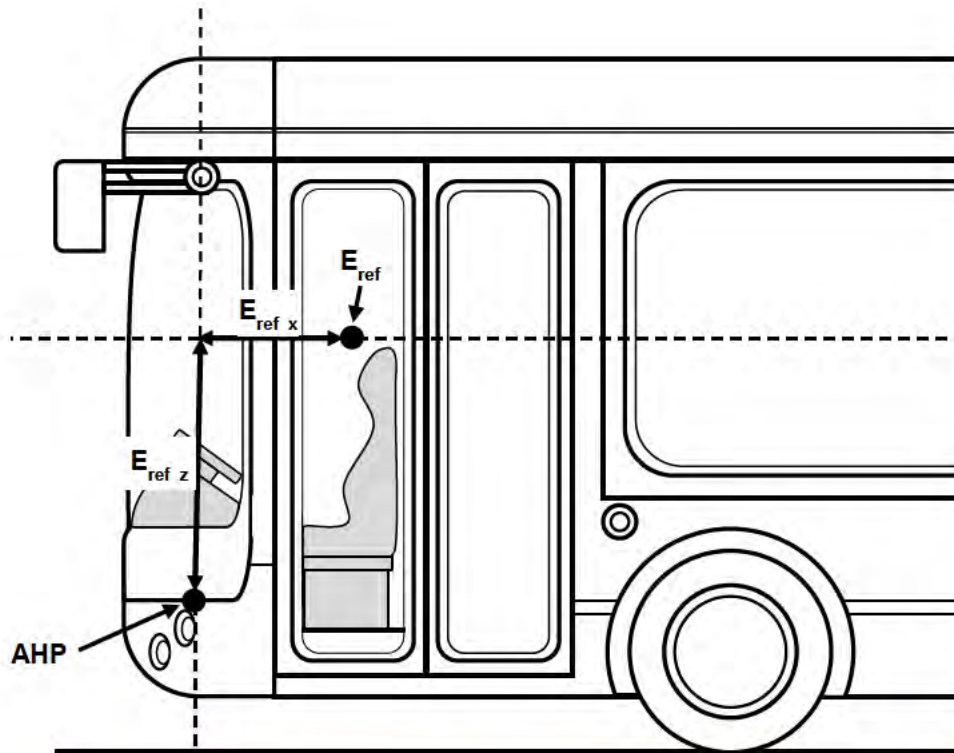

Figure19_2: Definition of vertical (E_{ref_z}) and rearward (E_{ref_x}) offset of the reference eye point (E_{ref}) from the accelerator heel point (AHP)

4.4 Neck Pivot Point Location (P)

The neck pivot point (P) is defined as an offset of $[0.098]m$ behind the E_{ref} point in the X axis, as shown in Figure .

4.5 Left and Right Eye Point Locations (E_L , E_R)

The left and right eye points (E_L and E_R) are defined as an offset of $\pm [0.0325]m$ from the E_{ref} point in the Y axis, as shown in Figure .

E_L and E_R are not required to defined the sightlines or vision volumes using the method defined in this document but are included for completeness.

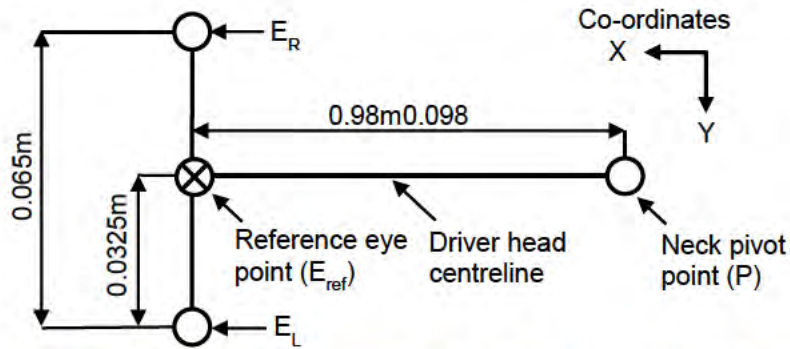

Figure 19_3: Definition of left and right eye point (E_L and E_R) positions relative to the neck pivot point (P) and reference eye point (E_{ref})

4.6 Neck Pivot Point Range of Motion (β)

The horizontal rotation (β) of the neck pivot point, which determines the relative motion of the eye points, is defined by a maximum range of motion of $[\pm 90^\circ]$ rotation about the neck pivot point (P), as shown in Figure .

There shall be no vertical rotation about the neck pivot point.

4.7 Eye Point Range of Motion (θ)

The horizontal rotation (θ_L , θ_R) for the Eye point E_C is defined by a maximum range of motion of $[\pm 30^\circ]$, as shown in Figure .

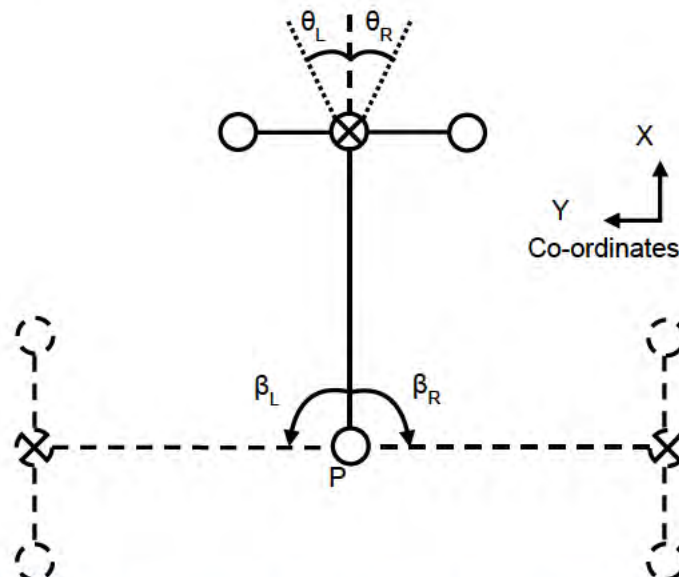

Figure 19_4: Plan view of horizontal neck point and eye point rotations

The vertical rotation (θ_U , θ_D) for the eye point is defined by a maximum range of motion of $[45^\circ]$ upwards and $[60^\circ]$ downwards as shown in Figure .

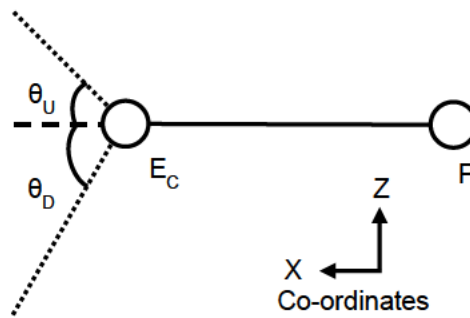

Figure 19_5: Side view of vertical eye point rotations

4.8 Camera Points

The field of view provided by each camera of a camera-monitor system (CMS) shall be defined by monocular vision originating from a specified camera point location from which sightlines will originate. Multiple camera point locations ($C_1, C_2 \dots C_n$) and fields of view may be defined for assessment.

4.9 Camera Point Locations (C)

Camera point locations (C), relative to the origin of the global coordinate system, shall be provided by the OEM for all CMS included in the BVS assessment. Each camera point location ($C_1, C_2 \dots C_n$) shall be located at the origin of the field of view for the relevant camera.

4.10 Camera Point Fields of View (α, λ)

The angle of the centre of the field of view shall be provided for each camera point (C_n) by the OEM, as shown in Figure19_6 and Figure .

The horizontal angle shall be formed between the centre of the field of view and XZ plane (α_n), with a positive value used when angled outboard relative to the XZ plane.

The maximum range of the horizontal field of view, both inboard and outboard ($\alpha_{n_i}, \alpha_{n_o}$), for each camera point (C_n) shall be provided by the OEM, as shown in Figure19_6.

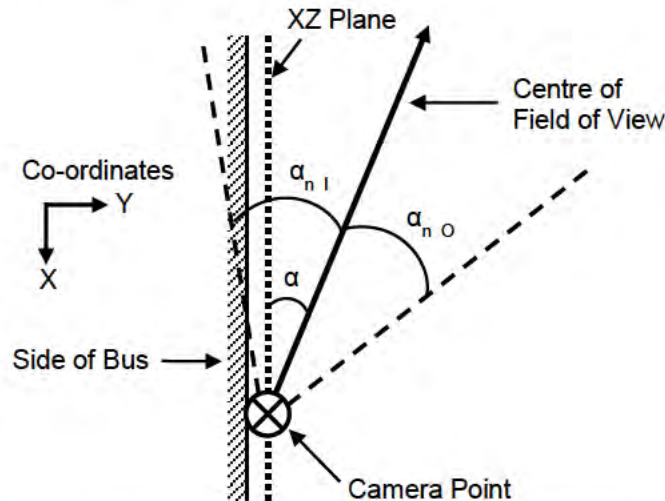

Figure19_6: Plan view of horizontal field of view range for camera point

The vertical angle shall be formed between the centre of the field of view and XY plane (λ_n), with a positive value used when angled downward relative to the XY plane.

The maximum range of the vertical field of view, both upward and downward ($\lambda_{n,U}$, $\lambda_{n,D}$), for each camera point (C_n) shall be provided by the OEM, as shown in Figure .

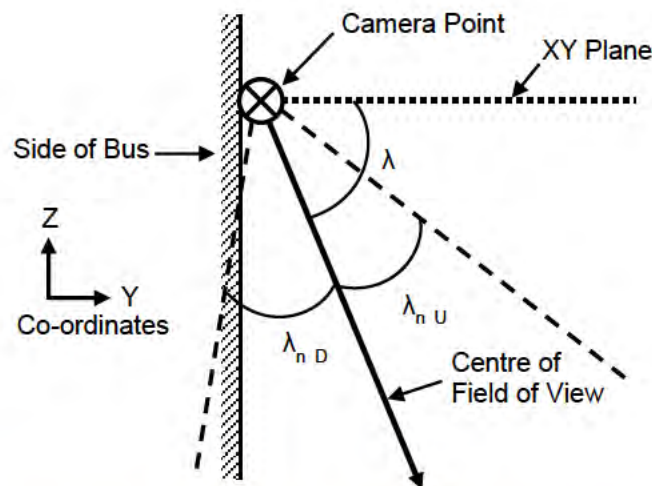

Figure 19_7: Frontal view of vertical field of view range for camera point

4.11 Assessment Zones

The following three assessment zones shall be defined:

- Forward Close Proximity Zone
- Rearward Close Proximity Zone
- Wide-Angle Zone

Where these assessment zones are defined in relation to the limits of the vehicle length and width, these limits shall include all relevant vehicle glazing and bodywork, but exclude all features listed in Appendix A.

4.12 Assessment Zone Height

Each assessment zone shall be formed by a volume, including the following defined areas, at heights from $Z = [1.177]$ m through to $Z = [1.602]$ m from the ground plane.

4.13 Forward Close Proximity Zone

The dimensions of the forward close proximity assessment zone are shown in Figure to 19_10 and described below:

- The fore outer boundary of the assessment zone is defined by a YZ plane located [2]m in front (+X axis) of the foremost aspect of the vehicle structure.
- The nearside (left side) outer boundary of the assessment zone is defined by a XZ plane located [4.5]m outboard (+Y axis) from the most lateral aspect of the nearside of the vehicle structure.
- The offside (driver side) outer boundary of the assessment zone is defined by a XZ plane located [2]m outboard (-Y axis) from the most lateral aspect of the offside of the vehicle structure.
- The rear outer boundary of the assessment zone is defined by a YZ plane located [1.75]m to the rear (-X axis) of the reference eye point (E_{ref}).
- The inner boundary is located 0.3m from the outermost aspect of the vehicle structure, when measured normal to the relevant vehicle structure (Figure). This may include curves, dependant on the geometry of the outmost vehicle structure.
- Assessment Zone height as per Section 4.12, shown in Figure 19_10

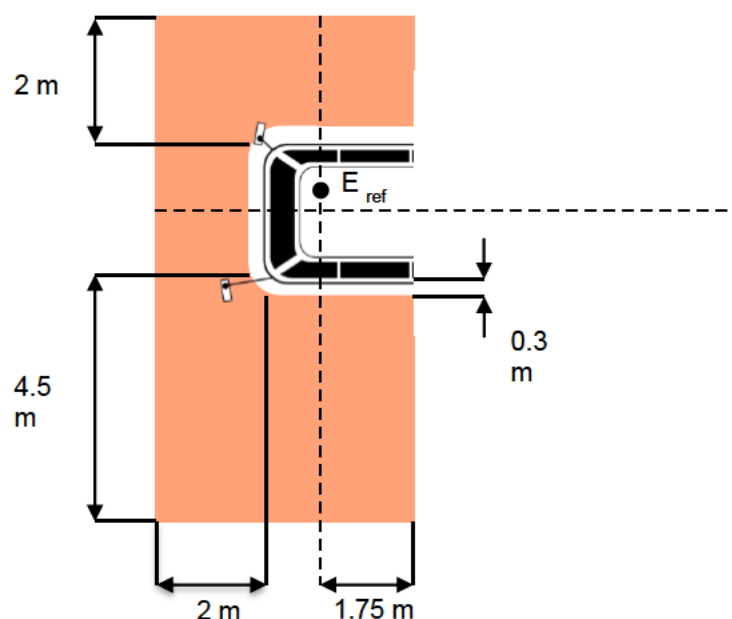

Figure 19_8: Plan view of forward close proximity assessment zone

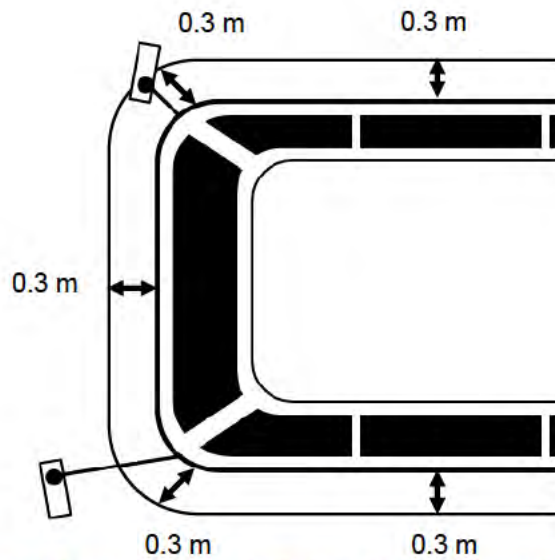

Figure 19_9: Illustration of profile for defining inner boundary of assessment zones

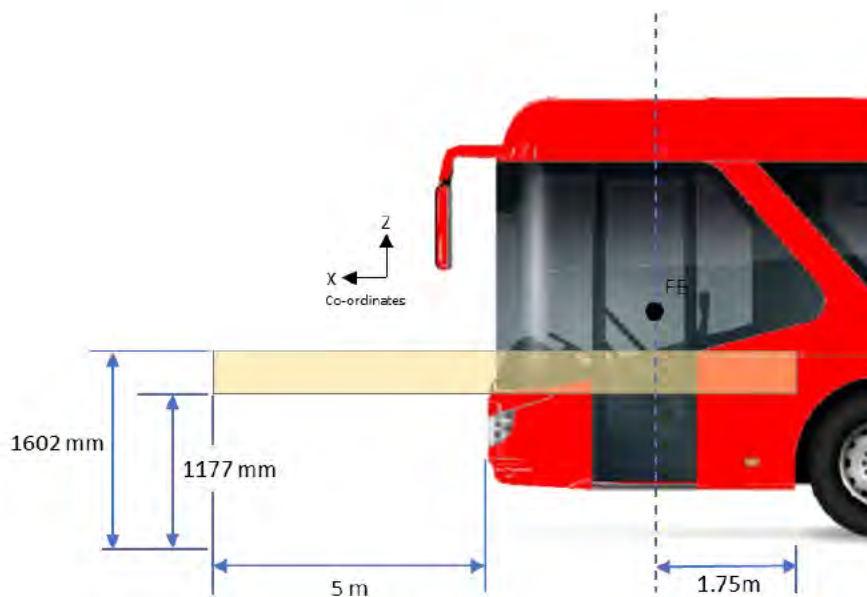

Figure 19_10: Side view of forward close proximity assessment zone

4.14 Rearward Close Proximity Zone

The dimensions of the rearward close proximity assessment zone are shown in Figure and described below:

- a) The fore outer boundary of the assessment zone is defined by a YZ plane and located [1.75]m to the rear (-X axis) of the reference eye point (E_{ref}).



- b) The nearside (left side) outer boundary of the assessment zone is defined by XZ plane and located [4.5]m outboard (+Y axis) from the most lateral aspect of the nearside of the vehicle structure.
- c) The offside (driver side) outer boundary of the assessment zone is defined by a XZ plane and located [2]m outboard (-Y axis) from the most lateral aspect of the offside of the vehicle structure.
- d) The rear outer boundary of the assessment zone is defined by a YZ plane and located [5]m to the rear (-X axis) of the rearmost aspect of the vehicle structure.
- e) The inner boundary is located 0.3m from the outermost aspect of the vehicle structure, when measured normal to the relevant vehicle structure (Figure). This may include curves, dependant on the geometry of the outmost vehicle structure.
- f) Assessment Zone height as per Section 4.12, shown in Figure 19_12

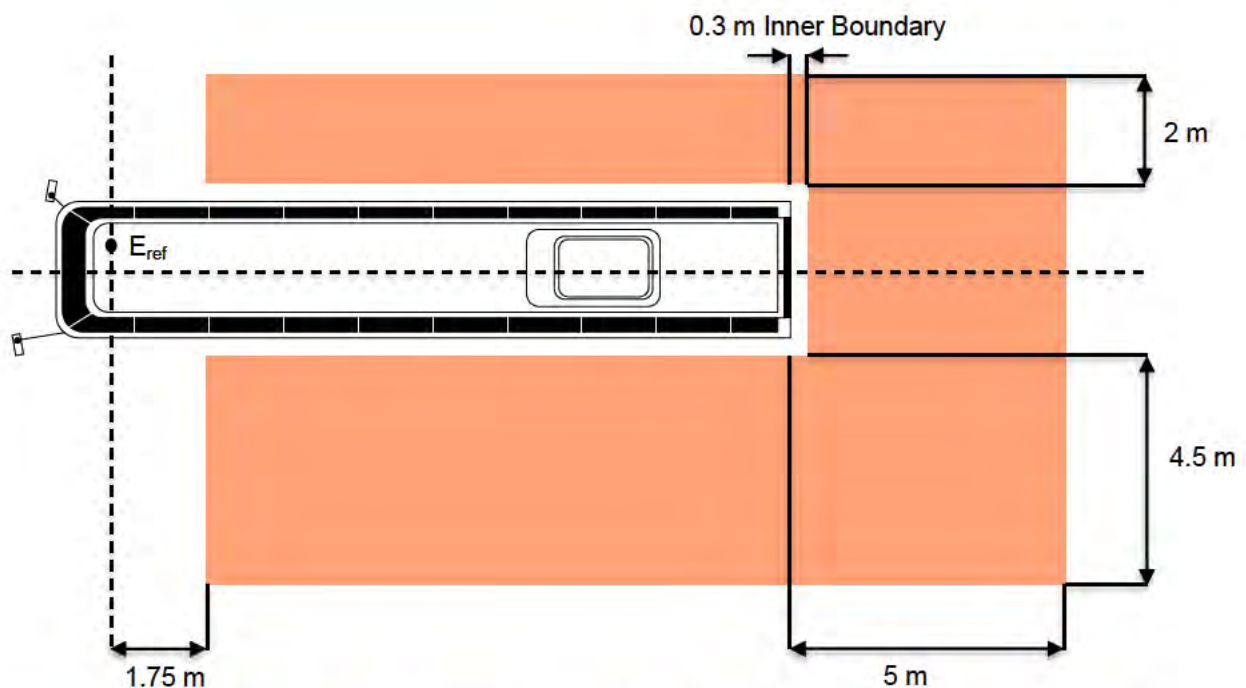

Figure 19_11: Plan view of rearward close proximity assessment zone



Figure 19_12: Side view of rearward close proximity assessment zone

4.15 Wide-Angle Zone

The dimensions of the wide-angle assessment zones, which are principally based on the field of vision zones specified for Class IV mirrors in UN ECE Regulation 46, are shown in Figure and described below:

- a) Nearside (left side) wide-angle assessment zone:
 - i. The fore boundary of the assessment zone is defined by a YZ plane, located [1.5]m rear (-X axis) of the reference eye point (E_{ref}).
 - ii. The rear boundary of the assessment zone is defined by a YZ plane located [25]m to the rear (-X axis) of the reference eye point (E_{ref}).
 - iii. The outer boundary of the assessment zone is defined by a XZ plane, located [15]m outboard (+Y axis) from the most lateral aspect of the nearside of the vehicle structure and a Z plane between [1.5]m rear (-X axis) of the reference eye point (E_{ref}) and [4.5]m outboard (+Y axis) from the most lateral aspect of the nearside of the vehicle structure and [10]m to the rear (-X axis) of the reference eye point (E_{ref}) and [15]m outboard (+Y axis) from the most lateral aspect of the nearside of the vehicle structure .
 - iv. The inner boundary of the assessment zone is defined by a XZ plane, located [4.5]m outboard (+Y axis) from the most lateral aspect of the nearside of the vehicle structure
 - v. Assessment Zone height as per Section 4.12, shown in Figure 19_14
- a) Offside (driver side) wide-angle assessment zones:
 - i. The fore boundary of the assessment zone is defined by a YZ plane, located [1.5]m to the rear (-X axis) of the reference eye point (E_{ref})
 - ii. The rear boundary of the assessment zone is defined by a YZ plane and located [25]m to the rear (-X axis) of the reference eye point (E_{ref})
 - iii. The outer boundary of the assessment zone is defined by a XZ plane, located [15]m outboard (-Y axis) from the most lateral aspect of the nearside of the vehicle structure and a Z plane between [1.5]m rear (-X axis) of the reference eye point (E_{ref}) and [4.5]m outboard (+Y axis) from the most lateral aspect of the nearside of the vehicle structure and [10]m to the rear (-X axis) of the reference eye point (E_{ref}) and [15]m outboard (+Y axis) from the most lateral aspect of the nearside of the vehicle structure



- iv. The inner boundary of the assessment zone is defined by a XZ plane and located [2]m outboard (-Y axis) from the most lateral aspect of the nearside of the vehicle structure
- v. Assessment Zone height as per Section 4.12, shown in Figure 19_14

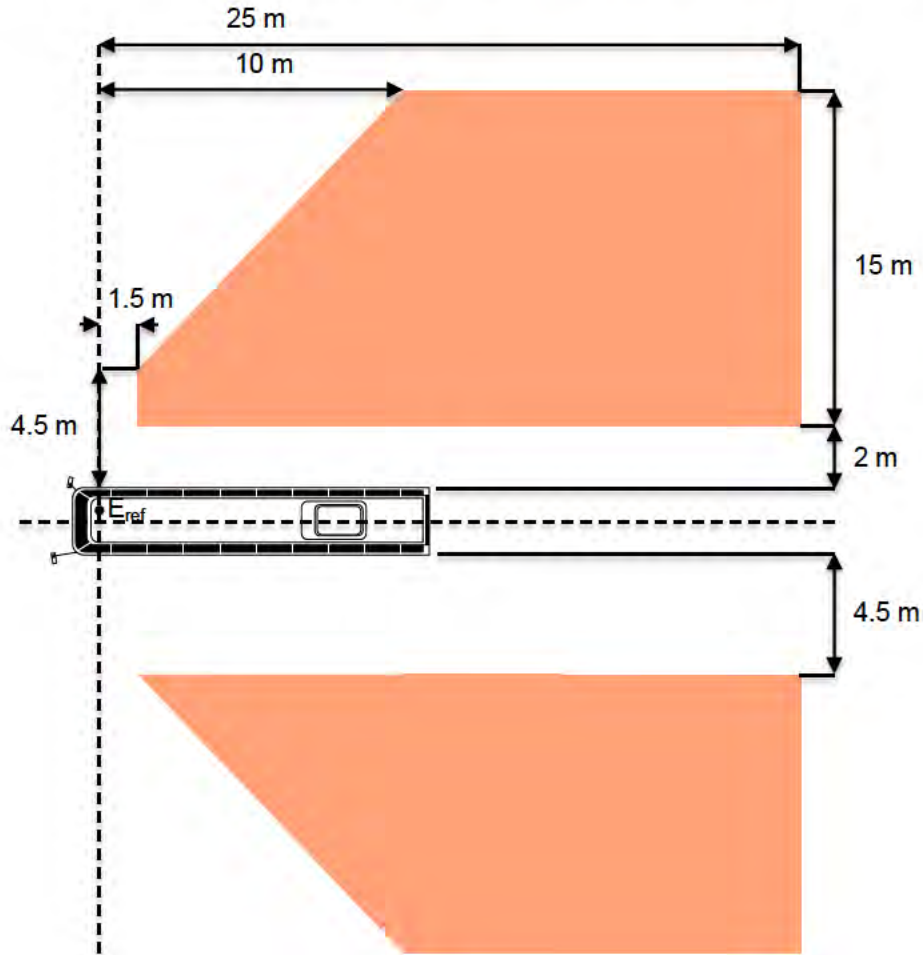

Figure 19_13: Plan view of wide-angle assessment zone



Figure 19_14: Plan view of wide-angle assessment zone



4.16 Assessment Zone Elements

Each assessment zone volume shall be split into individual, 3 dimensional elements, approximately equal in both size and shape, with no single dimension exceeding [0.1]m.

5 Vehicle preparation

5.1 CAD Model

The assessment requires a CAD model of the VUT that is of sufficient detail to allow accurate measurement of the direct and indirect fields of view available to the driver (Figure). This can either be supplied by the OEM or generated from laser scanning a physical vehicle where independent evaluation is considered necessary. The resulting CAD data must include any interior and exterior component geometry which may obstruct or reflect the sightline, including but not limited to:

- a) Exterior panels that bound any transparent area
- b) Exterior panels that define the extents of the vehicle to the front (e.g. bumper) and sides (e.g. wheel arches)
- c) Exterior elements that may obstruct driver vision including; mirrors and mirror arms, wipers and any other OEM fit feature or equipment
- d) Exterior mirrored surfaces that may reflect driver vision
- e) Interior surfaces that may obstruct driver vision including; the driver assault screen frame, dashboard, window seals/rubbers, trim panels on doors, A-pillars, B-pillars, grab handles, etc.
- f) Interior equipment that may obstruct driver vision including; ticket machines, rain sensors, monitors/screens or other controls or displays, etc.
- g) Key elements of the driver packaging including; seats, steering wheel, etc, and the AHP.



Figure 19_15: Example CAD data required for bus vision standard assessment

5.2 Glazing Frit

Where glazing incorporates a 'frit' (also known as 'black-off' or 'fade-off'), this area should be considered opaque. Thus, the daylight opening (DLO) boundary is defined by the inner boundary of any patterned area, as shown in Figure below.

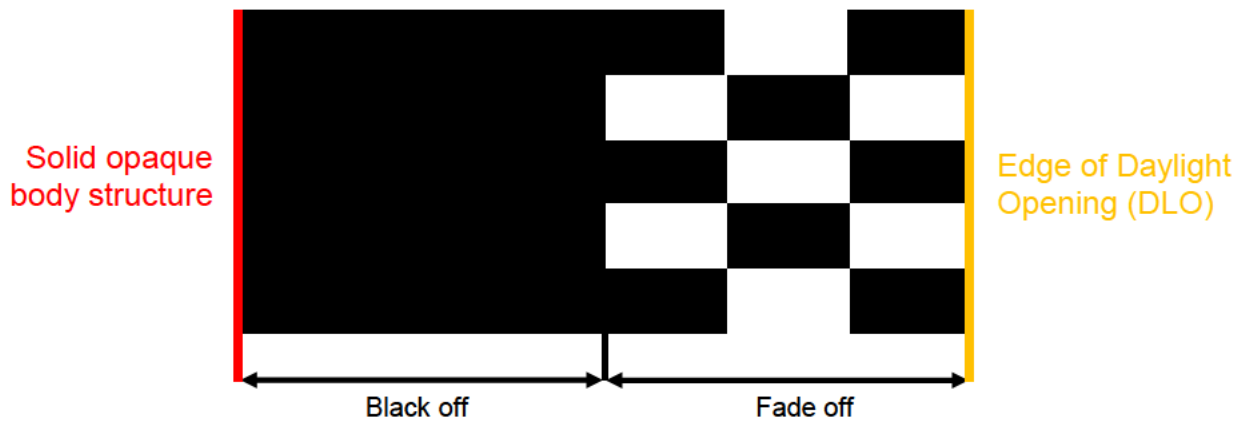

Figure 19_16: Definition of daylight opening (DLO) at window edges with black-off or fade-off areas

5.3 Tinting

Where any area of a windscreen or other glazed surface has a light transmittance of less than 70% (when measured normal to the surface), this area should be considered opaque. Thus, the DLO boundary is further defined by the boundaries of any tinted areas.

5.4 Glazing Angle

Where the angle of incidence (θ_i) between the surface of [any section of glazing] and the sightline from at least one eye is angled at greater than $[70^\circ]$, [when looking at the surface from any angle,] this area shall be considered opaque (Figure). The DLO boundary is therefore further defined by the boundaries of any glazed surfaces defined as opaque.

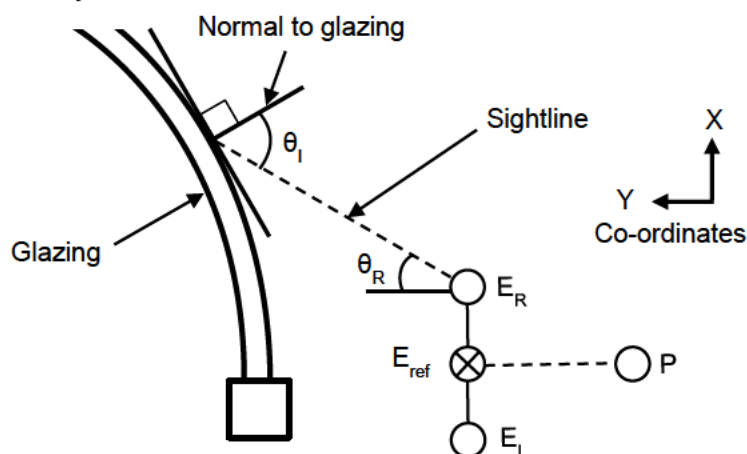

Figure 19_17: Illustration of angle of incidence between the sightline and glazing

5.5 Mirror Positioning

Accurate CAD models of mirror surfaces, mirror housings and mirror arms shall be included. Curved surfaces for non-planar mirrors shall be included. Mirror surfaces and mirror arm model information shall be recorded.

Mirror arms and housing shall be positioned in their in-use position, i.e. not stowed away.

If mirror housings provide a range of adjustment in their in-use position, they shall be adjusted to a representative position for the assessment. The angles that the mirror housing makes relative to the X, Y, and Z-axes of the vehicle shall be recorded, alongside the position of the attachment to the mirror arm.

Mirror surfaces shall then be adjusted within the mirror housing to meet UN ECE Regulation 46 requirements.

All mirrors, mirror housings and mirror arms shall be adjusted within OEM defined ranges of motion. All mirrored surfaces shall comply with the requirements relating to the radii of curvature in UN ECE Regulation 46. Any mirror not complying with these requirements shall be designated as part of the vehicle structure.

5.6 Camera-Monitor Systems (CMS)

Accurate CAD models of the exterior geometries for the camera, camera housing and monitor shall be included. Monitors shall be positioned in their OEM recommended positions, i.e. not stowed away. All camera-monitor systems (CMS) shall comply with UN ECE Regulation 46 requirements. Any CMS not complying with these requirements shall be designated as part of the vehicle structure.

5.7 Accelerator Heel Point (AHP) Height

Where different running gear (tyres, wheels, suspensions) are available on the same model, then by default, the CAD data shall reflect the worst-case configuration. This shall be the configuration that results in the AHP being at the greatest possible distance from the ground plane. The results of this assessment may then be applied to all variants with identical bodywork and mirror arrangements where the AHP is



nearer to the ground. Alternatively, the OEM may at their discretion assess more than one variant. CAD data shall represent a bus in the following running order:

- a) The suspension enabling the vehicle ground clearance to be adjusted, if applicable, is set to the highest setting for normal driving
- b) The specified tyres should be at their maximum ETRTO diameter
- c) The tyre pressures are set according to OEM's recommendations
- d) The fuel tank is filled to no greater than 10% of the capacity specified by the OEM
- e) Other fluid levels, such as lubricants, coolants, etc., are set according to OEM's recommendations
- f) The driver seat is occupied with a driver of 68 kg mass
- g) No additional payload or passenger ballast is added

5.8 Steering Wheel Position

The steering wheel shall be positioned in the geometric centre of the steering wheel adjustment envelope, as defined by the OEM.

5.9 Driver Seat Position

The driver seat shall be located at the rearmost and lowest point of the driver seat adjustment envelope, as defined by the OEM.

5.10 Accelerator Heel Point (AHP)

The CAD data shall contain a definition of the Accelerator Heel Point (AHP). The AHP is a key reference point for the definition of the eye points used for the assessment and shall be defined as per the process documented in SAE J1516, SAE J1517 and SAE J1100.

5.11 Other Vehicle Components

Adjustable equipment designed for intermittent use during rare circumstances while driving, such as windscreen wipers or windscreen sun visors, or for non-driving use shall be set in the not-in-use or stowed away position.

Adjustable equipment designed for regular use or that may reasonably be expected to be left permanently in the in-use position by most drivers, such as adjustable armrests, shall be in the in-use position and adjusted to represent the worst-case obstruction to direct vision, as determined by the test service.

All internal components entirely obstructed by the driver cab, such as passenger seats, poles, staircase, may be removed to speed up the simulation process. Such internal components have no effect on the vision zones.



6 Test procedure

Technically, it is possible to undertake this assessment using CAD software alone. However, it is considered that it would be very complex and time consuming. It is, therefore, recommended that the CAD models of both the vehicle and assessment zone are assessed using an automated computer programme.

An example of the sightlines to be assessed can be found in the breakdown of the neck pivot point and eye point angles provided in Appendix B.

6.1 Sightline Projection

Sightline projections shall be made and analysed according to the following procedure for a combination of different neck pivot point angles (β), measured at 10° increments, and eye point angles (θ), within the ranges defined in Section 4.

Sightline projections shall also be made and analysed for camera field of vision angles (α , λ), within the ranges specified by the OEM..

Each sightline shall be projected from a point of origin located at the cyclopean eye point or camera point location to be assessed.

The angle between each sightline, whether projected from the eye point or a camera, shall be such that each of the assessment zone elements may be intersected where no obstruction exists. For example, where elements of 0.1m have been used at a distance of 3m from the Eye point, angular increments of 1.5° or less should be used.

Each sightline shall be increased in length in increments of [0.1]m, to project along the eye point or camera point angle, until the sightline reaches a length of [40]m or intersects with the following:

- a) An opaque vehicle structure not defined as a mirrored surface. In this case, the projection of the sightline shall be terminated at the obstruction point.
- b) An opaque vehicle structure that is defined as a mirrored surface. In this case, the sightline shall be geometrically reflected by mirroring the angle of incidence relative to the normal of the mirror surface at the obstruction point.
- c) The end of the assessment zone.

6.2 Determining the Direct Vision Volume (V_D)

The determination of the Direct Vision Volume must be conducted before other vision volumes to ensure the Bus Vision Score weighting calculations are correctly applied.

All assessment zone elements intersected by a sightline originating from the cyclopean eye point (i.e. not at a camera point), but that has not been reflected from a mirrored surface, shall be designated as visible through the direct field of vision of the driver.

The volume of these individual elements shall be summed to form the direct vision volume (V_D).

The assessment procedure must ensure that any assessment zone element which is counted as part of the Direct Vision Volume is prevented from being counted again



as part of the Indirect Vision Volume. This is to prevent the double counting of any individual element which may produce a biased result.

All volumes shall be calculated in cubic millimetres (mm³) and to the nearest decimal place.

6.3 Determining the Indirect Vision Volume (V_I)

6.3.1 Indirect Vision Volume (V_I)

The indirect vision volume (V_I) associated with each assessment zone shall be calculated through the summation of the indirect vision volume for mirrors (V_{I_M}) and the indirect vision volume for CMS (V_{I_C}).

Thus, for each assessment volume:

$$V_I = V_{I_M} + V_{I_C}$$

All volumes shall be calculated in cubic millimetres (mm³) and to the nearest decimal place.

6.3.2 Mirrors (V_{I_M})

All assessment zone elements intersected by a sightline originating from the cyclopean eye point (i.e. not at a camera point) after having been reflected from a mirrored surface shall be designated as visible through the indirect field of vision of the driver using a mirror.

Any elements that have been found to be visible via the direct field of vision must not be included in this assessment to avoid “double counting” any elements..

The volume of these individual elements shall be summed to form the indirect vision volume for mirrors (V_{I_M}).

6.3.3 Camera-monitor Systems (CMS) (V_{I_C})

All assessment zone elements intersected by a sightline originating from a camera point, but that have not been found to be visible via either the direct field of vision or via reflection by a mirrored surface, shall be designated as visible through the indirect field of vision of the driver using a CMS.

The volume of the individual elements shall be summed to form the indirect vision volume for CMS (V_{I_C}).

$$V_I = V_{I_M} + V_{I_C}$$

6.4 Determining the Total Driver Vision Volume (V_T)

The total driver vision volume (V_T) associated with each assessment zone shall be calculated through the summation of the Direct vision volume (V_D) and the Indirect vision volume (V_I).

Thus, for each assessment volume:

$$V_T = V_D + V_I$$



All volumes shall be calculated in cubic millimetres (mm³) and to the nearest decimal place.

6.5 Determining the Blind Spot Volume (V_B)

The blind spot volume (V_B) associated with each assessment zone shall be calculated through the subtraction of the total driver vision volume (V_T) from the assessment zone volume (V_A).

Thus, for each assessment volume:

$$V_B = V_A - V_T$$

All volumes shall be calculated in cubic millimetres (mm³) and to the nearest decimal place.

7 Assessment of results

7.1 Direct Vision Performance Score (DVS)

The direct vision performance score calculates the proportion of each assessment zone visible to the driver through the direct field of view. This is calculated by dividing the relevant direct vision volume (V_D) by the assessment zone volume (V_A).

Thus, for each assessment volume:

$$DVS = \frac{V_D}{V_A} \%$$

The direct vision performance score shall be calculated as a percentage to [a single] decimal place.

7.2 Indirect Vision Performance Score (IVS)

The indirect vision performance score calculates the proportion of each assessment zone visible to the driver through the indirect field of view. This is calculated by dividing the relevant indirect vision volume (V_I) by the assessment zone volume (V_A).

Thus, for each assessment volume:

$$IVS = \frac{V_I}{V_A} \%$$

The indirect vision performance score shall be calculated as a percentage to [a single] decimal place.

7.3 Total Driver Vision Performance Score (TVS)

The total driver vision performance score calculates the proportion of each assessment zone visible to the driver through the direct and indirect fields of view. This is calculated by dividing the relevant total driver vision volume (V_T) by the assessment zone volume (V_A).

Thus, for each assessment volume:



$$TVS = \frac{V_T}{V_A} \%$$

The total driver vision performance score shall be calculated as a percentage to [a single] decimal place.

7.4 Bus Vision Standard Performance Rating Score (BVS)

The bus vision standard performance rating score calculates a normalised, weighted, score to provide an overall rating score to describe the relative safety performance of different vehicles.

[London collision data has been used to weight the importance of each assessment zone with respect to the potential casualty prevention potential of each zone around the vehicle.] This has been combined with research further weighting the differences in importance between direct and indirect vision with respect to their relative casualty prevention potentials. These weighting factors are shown in Table 9.

Table 9: Weighting factors for each assessment zone

Assessment Zone	Direct Vision Weighting Factor (W_D)	Indirect Vision Weighting Factor (W_I)	Casualty Weighting Factor (W_C)
Forward Close Proximity Zone	100%	50%	[69]%
Rearward Close Proximity Zone	-	100%	[28]%
Wide Angle Zones	-	100%	[3]%

Note: Rearward close proximity and wide angle zones should be visible through indirect vision only

The weighted bus vision standard performance rating score for each assessment zone is calculated by the summation of the weighted direct and indirect vision performance scores, calculated by multiplying the DVS and IVS with the relevant casualty weighting factor.

$$\text{Zone BVS} = W_C(DVS \times W_D) + (IVS \times W_I)$$

The overall bus vision standard performance rating score (BVS) of the VUT shall be calculated by summing the weighted scores of each assessment zone and shall be calculated as a percentage to a single decimal place.

Table 10 shows hypothetical results as a worked example.

Table 10: Example scoring and weighting process to obtain the overall bus vision standard performance rating score (BVS) for the VUT

Assessment Zone	DVS	W_D	IVS	W_I	W_C	BVS
Forward Close Proximity Zone	89.7%	100%	5.2%	50%	[69]%	63.7%
Rearward Close Proximity Zone	-	-	30.3%	100%	[28]%	8.5%
Wide Angle Zones	-	-	12.8%	100%	[3]%	0.4%
Overall BVS						72.6%



8 Test report

The Test Service shall provide a comprehensive Test Report that will be made available to TfL. The test report shall consist of three distinct sections:

- a) Performance data
- b) Confirmation of protocol compliance
- c) Reference information

8.1 Performance Data

Table 11: **Performance data template for test report** shows the performance data to be produced for each vehicle assessed.

Table 11: Performance data template for test report

Performance Measure	Forward Close Proximity Zone	Rearward Close Proximity Zone	Wide Angle Zones
Assessment Zone Volume (V_A) /mm³			
Direct Vision Volume (V_D) /mm³		-	-
Indirect Vision Volume for Mirrors ($V_{I M}$) /mm³			
Indirect Vision Volume for Cameras ($V_{I C}$) /mm³			
Indirect Vision Volume (V_I) /mm³			
Total Driver Vision Volume (V_T) /mm³			
Blind Spot Volume (V_B) /mm³			
Direct Vision Performance Score (DVS) /%			
Indirect Vision Performance Score (IVS) /%			
Total Driver Vision Performance Score (TVS) /%			
Bus Vision Standard Performance Score (BVS) /%			
Overall Bus Vision Standard Performance			

Score (BVS) /%	
-----------------------	--

In addition to the necessary performance data, the Test Service shall provide images with the Test Report illustrating the visible volumes and blind spots associated with each assessment volume. As a minimum requirement, these images shall include a plan view of the blind spot volumes associated with each assessment zone, but may also be combined with images including isometric views, side views, etc. to support understanding of the principle causes of the blind spots. Such images shall be colour coded to distinguish between the visible and blind spot volumes and may also be separated by whether areas are visible by direct or indirect vision (mirrors/cameras). A legend to the colour coding shall be provided within the Test Report. Hypothetical examples are shown in Figure 13.

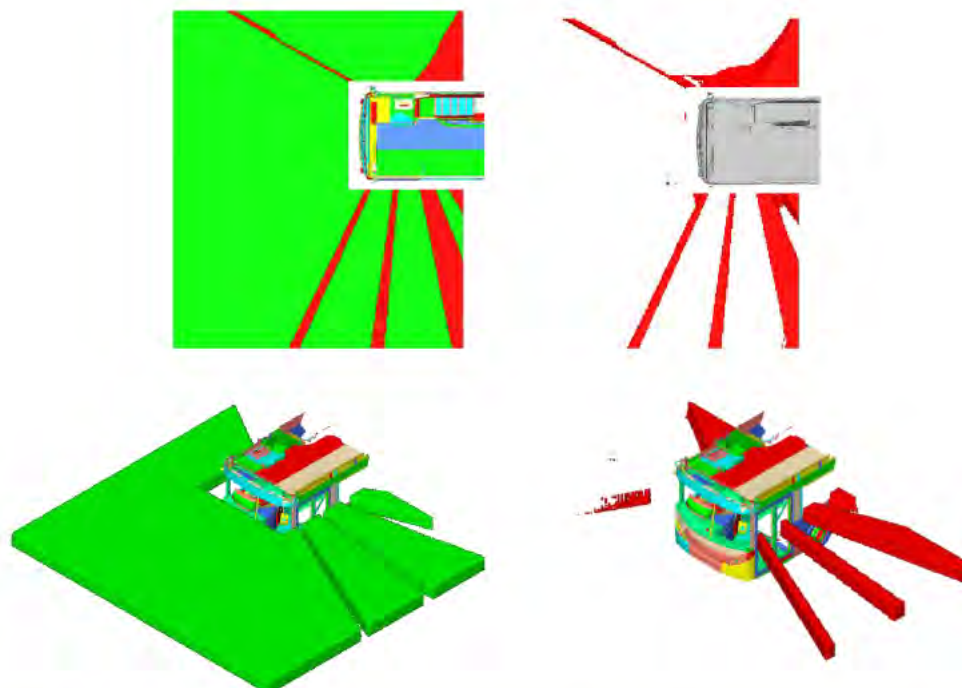

Figure 13: Example images showing Direct Vision Volume (green) and Blind Spot Volume (red) for the forward close proximity assessment zone

8.2 Protocol Compliance

To confirm protocol compliance, the Test Service shall provide information including:

- a) Details of the software packages used (e.g. CAD software)
- b) Origin of the CAD model (i.e. from OEM or result of laser scan).
- c) Information that may be used to verify the level of detail of the CAD model.
- d) Minimum and maximum element sizes used for the assessment zones.

8.3 Reference Information

As a minimum, the Test Service shall provide reference information including:

- a) Vehicle make



- b) Vehicle model
- c) Vehicle model variant
- d) Vehicle running order information
- e) Vehicle steering wheel and driver seat positions
- f) AHP location
- g) Mirror and mirror arm model/s fitted
- h) CMS model/s fitted, if applicable
- i) Mirror positioning, including information on locations and adjustment angles
- j) CMS information, including locations and fields of view
- k) Details on any glazed areas defined as opaque (due to frit/tinting/angle)
- l) Details of the Test Service
- m) Test date(s)



Appendix A - Components excluded in defining the assessment zones

Vehicle length

Vehicle length relates to a dimension is measured according to ISO standard 612-1978, term No. 6.1. In addition to the provisions of this standard, when measuring vehicle length, the following components shall not be taken into account:

- Wiper and washer devices
- Front or rear marker-plates
- Customs sealing devices and their protection
- Devices for securing the load restraint(s)/cover(s) and their protection
- Lighting and light signalling devices
- Mirrors or other devices for indirect vision
- Reversing aids
- Air-intake pipes
- Length stops for demountable bodies
- Access steps and hand-holds
- Ram rubbers and similar equipment
- Lifting platforms, access ramps and similar equipment in running order, not exceeding 300 mm
- Coupling and recovery towing devices for power driven vehicles
- Trolleybus current collection devices in their elevated and retracted positions
- External sun visors
- De-mountable spoilers
- Exhaust pipes

Vehicle width

Vehicle width relates to a dimension is measured according to ISO standard 612-1978, term No. 6.2. In addition to the provisions of this standard, when measuring the vehicle width, the following components shall not be taken into account:

- Customs sealing devices and their protection
- Devices for securing the tarpaulin and their protection
- Tyre failure tell-tale devices
- Protruding flexible parts of a spray-suppression system
- Lighting and light signalling devices
- For buses, access ramps, lifting platforms and similar equipment in their stowed position
- Rear-view mirrors or other devices for indirect vision,
- Tyre-pressure indicators
- Retractable steps
- The deflected part of the tyre walls immediately above the point of contact with the ground
- External lateral guidance devices of guided buses
- Running boards
- De-mountable mudguard broadening



Appendix B - Example breakdown of head and eye angles

Head Angles (degrees)

		-90	-80	-70	-60	-50	-40	-30	-20	-10	0	10	20	30	40	50	60	70	80	90	
Vertical	0	X	X	X	X	X	X	X	X	X	X	X	X	X	X	X	X	X	X	X	X

Eye Angle (degrees)

		Horizontal																					
		-30	-27	-24	-21	-18	-15	-12	-9	-6	-3	0	3	6	9	12	15	18	21	24	27	30	
Vertical	-60	X	X	X	X	X	X	X	X	X	X	X	X	X	X	X	X	X	X	X	X	X	X
	-57	X	X	X	X	X	X	X	X	X	X	X	X	X	X	X	X	X	X	X	X	X	X
	-54	X	X	X	X	X	X	X	X	X	X	X	X	X	X	X	X	X	X	X	X	X	X
	-51	X	X	X	X	X	X	X	X	X	X	X	X	X	X	X	X	X	X	X	X	X	X
	-48	X	X	X	X	X	X	X	X	X	X	X	X	X	X	X	X	X	X	X	X	X	X
	-45	X	X	X	X	X	X	X	X	X	X	X	X	X	X	X	X	X	X	X	X	X	X
	-42	X	X	X	X	X	X	X	X	X	X	X	X	X	X	X	X	X	X	X	X	X	X
	-39	X	X	X	X	X	X	X	X	X	X	X	X	X	X	X	X	X	X	X	X	X	X
	-36	X	X	X	X	X	X	X	X	X	X	X	X	X	X	X	X	X	X	X	X	X	X
	-33	X	X	X	X	X	X	X	X	X	X	X	X	X	X	X	X	X	X	X	X	X	X
	-30	X	X	X	X	X	X	X	X	X	X	X	X	X	X	X	X	X	X	X	X	X	X
	-27	X	X	X	X	X	X	X	X	X	X	X	X	X	X	X	X	X	X	X	X	X	X
	-24	X	X	X	X	X	X	X	X	X	X	X	X	X	X	X	X	X	X	X	X	X	X
	-21	X	X	X	X	X	X	X	X	X	X	X	X	X	X	X	X	X	X	X	X	X	X
	-18	X	X	X	X	X	X	X	X	X	X	X	X	X	X	X	X	X	X	X	X	X	X
	-15	X	X	X	X	X	X	X	X	X	X	X	X	X	X	X	X	X	X	X	X	X	X
	-12	X	X	X	X	X	X	X	X	X	X	X	X	X	X	X	X	X	X	X	X	X	X
	-9	X	X	X	X	X	X	X	X	X	X	X	X	X	X	X	X	X	X	X	X	X	X
	-6	X	X	X	X	X	X	X	X	X	X	X	X	X	X	X	X	X	X	X	X	X	X
	-3	X	X	X	X	X	X	X	X	X	X	X	X	X	X	X	X	X	X	X	X	X	X
	0	X	X	X	X	X	X	X	X	X	X	X	X	X	X	X	X	X	X	X	X	X	X
	3	X	X	X	X	X	X	X	X	X	X	X	X	X	X	X	X	X	X	X	X	X	X
	6	X	X	X	X	X	X	X	X	X	X	X	X	X	X	X	X	X	X	X	X	X	X
	9	X	X	X	X	X	X	X	X	X	X	X	X	X	X	X	X	X	X	X	X	X	X
12	X	X	X	X	X	X	X	X	X	X	X	X	X	X	X	X	X	X	X	X	X	X	
15	X	X	X	X	X	X	X	X	X	X	X	X	X	X	X	X	X	X	X	X	X	X	
18	X	X	X	X	X	X	X	X	X	X	X	X	X	X	X	X	X	X	X	X	X	X	
21	X	X	X	X	X	X	X	X	X	X	X	X	X	X	X	X	X	X	X	X	X	X	
24	X	X	X	X	X	X	X	X	X	X	X	X	X	X	X	X	X	X	X	X	X	X	
27	X	X	X	X	X	X	X	X	X	X	X	X	X	X	X	X	X	X	X	X	X	X	
30	X	X	X	X	X	X	X	X	X	X	X	X	X	X	X	X	X	X	X	X	X	X	
33	X	X	X	X	X	X	X	X	X	X	X	X	X	X	X	X	X	X	X	X	X	X	
36	X	X	X	X	X	X	X	X	X	X	X	X	X	X	X	X	X	X	X	X	X	X	
39	X	X	X	X	X	X	X	X	X	X	X	X	X	X	X	X	X	X	X	X	X	X	
42	X	X	X	X	X	X	X	X	X	X	X	X	X	X	X	X	X	X	X	X	X	X	
45	X	X	X	X	X	X	X	X	X	X	X	X	X	X	X	X	X	X	X	X	X	X	



Attachment 20: Bus Vision Standard

Guidance Notes

1 Introduction

All buses shall allow the driver to have sufficient vision of their surroundings to allow the execution of all driving tasks required in service in London.

All buses shall have a high standard of direct and indirect vision in areas close to the vehicle where vulnerable road users are at particular risk of collision with a bus undertaking low speed manoeuvres. This is referred to as close proximity vision.

This document sets out the guidance notes related to the assessment of Direct and Indirect Vision. These guidance notes are aimed at bus operators and OEMs as a practical guide for implementation of the Bus Safety Standard.

These notes are for guidance only, and are not legally binding. In all circumstances, the guidance provided by an OEM or system supplier shall take precedence, and these guidance notes are only for use in the absence of other information. These are not intended to be exhaustive, but to point the operators toward practical advice and questions to raise with OEMs/suppliers.

2 Selection of buses/systems

Any bus that meets the TfL Bus Vehicle Specification.

The Direct and Indirect Vision requirements may be assessed against a new build bus, or against a vehicle fitted with an aftermarket retrofit vision system.

2.1 Compliance and warranty

A bus operator should ask to see compliance certificates for UNECE Regulation 46 and warranty information for any camera monitor system (CMS) from the bus OEM and/or the aftermarket supplier.

2.2 Requirement interpretation and application guidance

The requirements relate to both direct vision, where the driver looks directly through the windows and transparent areas of the bus structure in order to see the road and traffic environment outside, and indirect vision, where the driver looks in mirrors, monitors or other devices to see parts of the road and traffic environment around the vehicle.

In order allow the driver to recognise a potentially dangerous situation while undertaking low speed manoeuvring and successfully avoid a collision the following elements are required:



- **Available to be seen:** The hazard (pedestrian, cyclist, other vehicle etc.) needs to be available to be seen by the driver sufficiently ahead of time to allow avoiding action to be taken. That means the hazard needs to be in view at least approximately 2 seconds before collision
- **Alert and attentive:** The driver needs to be attentive to the road and traffic environment and alert to the possible need to react
- **Looking in the right direction:** In complex driving situations, the driving task can demand attention in multiple different directions; the driver needs to be looking in the right direction at the right time to see the hazard. In dynamic moving environments this is not guaranteed even if the driver is alert and attentive.
- **Recognition:** Once the hazard is seen, then the driver must recognise the hazard and the risk that it poses
- **Reaction:** Once the risk is recognised, the driver must react quickly and correctly to the risk; in some circumstances this may be steering around the hazard, in many it will be braking the vehicle to a stop and in others it might simply be to remain stationary instead of moving off from rest.

Direct vision and each different form of indirect vision have different benefits and disbenefits. The Bus Vision Standard and associated protocol recognises that current buses already have very good direct vision relative to other large vehicles and so sets a minimum criteria that ensures that standard is maintained in the face of other competing pressures in future. It allows for improvements over and above this minimum standard but also recognises that the opportunities for improvement are relatively small.

In addition to this, the Bus Vision Standard defines a minimum standard for the overall level of vision, whether implemented via direct or indirect vision. It is not prescribed how this should be achieved and allows for vision performance over and above the minimum standard. This leaves OEMs and operators to choose the solutions that work best with their designs and operations. In making those choices, OEMs and operators should bear in mind the requirements above, the guidance below about different aspects of different solutions and the interaction with systems such as blind spot warning or intervention systems (BSW) (see separate BSW requirements, test procedures and guidance documents).

2.3 Direct vision

Direct vision is generally seen as being more effective than indirect vision. This is because it offers benefits in the 'recognition' phase described above. For example, objects appear at life size, free from distortion and movement of a hazard relative to the vehicle is large and more likely to attract attention in peripheral vision. In addition to this, it is possible for drivers to make eye-contact with other road users around the vehicle which is thought to improve confidence that people have been seen and to help read intention of next moves. There is experimental evidence to show that drivers react significantly more quickly to the presence of vulnerable road users around the vehicle when they are seen via direct vision, rather than via indirect vision.

However, it is not practically possible to see all necessary areas around a large vehicle via direct vision. In particular any area significantly rearward of the driver's



eye point will be difficult because of the need for the driver to rotate eyes, neck and even body to direct their view there and because buses serve a purpose and seats, passengers and other structural elements cannot all be made transparent.

2.4 Indirect vision

The use of mirrors or camera monitor systems can be cost effective solutions that allow areas to the rear of the driver's eyes or specific blind spots in the forward field of view to be easily seen. However, as previously discussed, experimental evidence has shown the ability of drivers to recognise hazards can be more difficult when reliant on indirect vision rather than via direct vision. The following should be considered when implementing indirect vision:

- **Image size:** Hazards seen in mirrors or monitors are typically smaller than life size and their relative motion with the vehicle less easy to identify in peripheral vision. Thus, larger mirrors or monitors may be preferable to smaller devices.
- **Conflicts with direct vision:** Mirrors or monitors placed in areas around windows can cause some obstruction to direct vision. In this case smaller devices may be considered preferable. However, compromises that position devices in places where direct vision is less important or where it coincides with existing less avoidable obstructions such as A-pillars already exist may be better, bearing in mind the possible recognition benefits of larger images.
- **Distortion:** Strongly curved mirrors or fish eye camera lenses can produce very large fields of view from a single source, which can be seen as a benefit if the size of the view is all that is considered and not the quality of the image. Each of these techniques can also distort images making it harder for drivers to recognise hazards and interpret risk particularly during quick mirror checks. Sophisticated software in some camera monitor systems may be able to enhance images in poor conditions such that image quality is higher than with equivalent mirrors.
- **Driver workload:** Evidence in HGVs suggests that scanning direct vision and up to 6 mirrors during a complex low speed manoeuvre takes a significant amount of time. This increases driver workload such that although a hazard may more often be 'available to be seen' the driver may be looking in the right place at the right time less frequently, while still being diligently attentive and alert. Thus, indirect vision devices that add to driver workload by increasing the number of places they need to look or by requiring them to move their gaze further from the other areas they need to scan are likely to increase driver workload. This may detract from, or even reverse, the other benefits that the devices provide.
- **Adjustment:** Poor adjustment of mirrors, cameras views and monitors can greatly reduce the useful available view from the device. Operators should request guidance from the bus OEM or aftermarket supplier regarding the correct adjustment of the mirror or CMS.

The protocol has been designed to minimise the likelihood of such occurrences and requires compliance with the minimum standards set in these respects by UNECE Regulation 46. However, a wide range of differences in approach are still possible within these constraints and OEMs and operators should aim to select the best



solutions they can bearing in mind these factors and their other operational constraints.

A camera monitor system which is intended to replace mirrors may resolve some of the potential conflicts by varying the views displayed on its monitors, depending on the vehicle and traffic situation at the time. For example, class II mirrors may be removed and replaced by a rectangular monitor mounted on each A-pillar. The camera system may also be capable of showing a class V close proximity side view and/or a rear view immediately behind the vehicle. When travelling forward at normal speeds the offside mirror may show the class II display only, the nearside may show a large class II display and a small class V display. At low speeds when indicators are activated this ratio may reverse such that a large class V view is displayed and a small class II. When reverse is selected perhaps both monitors may show a 50/50 class II and rear vision view. This approach has clear potential benefits but is a new technology and the workload requirements and effects on recognition are not clearly understood at this time. Such systems are well worth investigation but operators may wish to consider trialling them in pilot phases with objective feedback from drivers before widespread rollout.

3 Training

3.1 For test Services

The recommended method to complete the assessment involves the use of CAD and finite element (FE) modelling. Therefore the respective test service conducting an assessment should have the relevant expertise to implement such techniques.

Test services accredited to undertake approval tests to UNECE Regulation 46 will be considered suitable to undertake performance tests if they can also prove the necessary CAD and FE expertise. Test services without such accreditation will be required to demonstrate to TfL at their own expense that they can achieve the same standard of testing as an accredited organisation.

3.2 Bus drivers

Drivers should be trained to correctly adjust mirrors and/or CMS to provide the required field of view, in accordance with the guidance from the OEM or aftermarket supplier.

Where a monitor is used to meet the indirect vision requirements, drivers should be trained to understand the orientation and perspective of the image. In particular, where a camera monitor system replaces existing mirrors, drivers should be thoroughly familiarised with the system.

3.3 Shift Supervisors

Supervisors should ensure drivers correctly adjust mirrors and/or CMS to provide the required field of view and are familiar with the image provided by camera monitor systems.

3.4 Bus maintenance engineers



The engineers carrying out general bus maintenance should be aware of the location and details of any cameras related to a CMS. Training should be based on the OEMs' guidance. This should include understanding the importance of ensuring the cameras are correctly aligned, undamaged and unobstructed.

4 Maintenance

Operators are encouraged to establish what (if any) daily checks are required, and to plan for these additional operational costs.

5 Repair

If during system maintenance checks (Section 4) any of the mirrors and/or cameras is deemed to be faulty or failing they should be replaced as soon as possible. The extent of the vision provided by the mirrors and/or cameras is completely contingent on the mirrors and cameras being clean and undamaged.

Attachment 21: Blind Spot Mirrors

Guidance Notes

1 Introduction

All buses shall allow the driver to have sufficient vision of their surroundings to allow the execution of all driving tasks required in service in London.

All buses shall have a high standard of direct and indirect vision in areas close to the vehicle where vulnerable road users are at particular risk of collision with a bus undertaking low speed manoeuvres. This is referred to as close proximity vision.

This document sets out the guidance notes related to the assessment of Direct and Indirect Vision, specifically in relation to blind spot mirrors. These guidance notes are aimed at bus operators and OEMs as a practical guide for implementation of the Bus Safety Standard.

These notes are for guidance only, and are not legally binding. In all circumstances, the guidance provided by an OEM or system supplier shall take precedence, and these guidance notes are only for use in the absence of other information. These are not intended to be exhaustive, but to point the operators toward practical advice and questions to raise with OEMs/suppliers.

2 Selection of buses/systems

Any bus that meets the TfL Bus Vehicle Specification.

The Direct and Indirect Vision requirements may be assessed against a new build bus, or against a vehicle fitted with an aftermarket retrofit blind spot mirror system.

2.1 Compliance and warranty

A bus operator should ask to see documentary evidence of compliance with the requirements.

2.2 Considerations for the utilisation of Blind spot mirrors

The use of mirrors can be a cost effective solution that allow areas to the rear of the driver's eyes or specific blind spots in the forward field of view to be easily seen. However, experimental evidence has shown the ability of drivers to recognise hazards can be more difficult when reliant on indirect vision rather than via direct vision. The following should be considered when utilising indirect vision:

- **Image size:** Hazards seen in mirrors are typically smaller than life size and their relative motion in regards to the vehicle less easy to identify in peripheral vision. Thus, larger mirrors may be preferable to smaller devices.
- **Distortion:** Strongly curved mirrors can produce very large fields of view from a single source, which can be seen as a benefit if the size of the view is all



that is considered and not the quality of the image. They can however also distort the image making it harder for drivers to recognise hazards and interpret risk particularly during quick mirror checks.

- **Driver workload:** Evidence in HGVs suggests that scanning direct vision and up to 6 mirrors during a complex low speed manoeuvre takes a significant amount of time. This increases driver workload such that, although a hazard may more often be 'available to be seen', the driver may be looking in the right place at the right time less frequently, while still being diligently attentive and alert. Thus, indirect vision devices that add to driver workload by increasing the number of places they need to look or by requiring them to move their gaze further from the other areas they need to scan are likely to increase driver workload. This may detract from, or even reverse the other benefits that the devices provide.
- **Adjustment:** Poor adjustment of blind spot mirrors can greatly reduce the useful available view from the device. Operators should request guidance from the OEM or aftermarket supplier regarding the correct adjustment of the mirror.

A wide range of differences in approach are still possible within these constraints and OEMs and operators should aim to select the best solutions they can bearing in mind these factors and their other operational constraints.

3 Training

3.1 Bus drivers

Drivers should be trained to appropriately install and correctly adjust mirrors to provide the required field of view, in accordance with the guidance from the OEM or aftermarket supplier.

3.2 Shift Supervisors

Supervisors should ensure drivers correctly adjusting mirrors to provide the required field of view.

4 Maintenance

Operators are encouraged to establish what (if any) daily checks are required, and to plan for these additional operational costs.

5 Repair

If during system maintenance checks (section 4) any of the mirrors are deemed to be faulty or failing they should be replaced as soon as possible. The extent of the vision provided by the mirrors is completely contingent on them being clean and undamaged.



Attachment 22: Camera Monitor Systems (CMS) Guidance Notes

1 Introduction

All buses shall allow the driver to have sufficient vision of their surroundings to allow the execution of all driving tasks required in service in London.

All buses shall have a high standard of direct and indirect vision in areas close to the vehicle where vulnerable road users are at particular risk of collision with a bus undertaking low speed manoeuvres. This is referred to as close proximity vision.

This document sets out the guidance notes related to the assessment of Direct and Indirect Vision, specifically in relation to camera monitor systems. These guidance notes are aimed at bus operators and OEMs as a practical guide for implementation of the Bus Safety Standard.

These notes are for guidance only, and are not legally binding. In all circumstances, the guidance provided by an OEM or system supplier shall take precedence, and these guidance notes are only for use in the absence of other information. These are not intended to be exhaustive, but to point the operators toward practical advice and questions to raise with OEMs/suppliers.

2 Selection of buses/systems

Any bus that meets the TfL Bus Vehicle Specification.

The Direct and Indirect Vision requirements may be assessed against a new build bus, or against a vehicle fitted with an aftermarket retrofit camera monitor system.

2.1 Compliance and warranty

A bus operator should ask to see compliance certificates for UNECE Regulation 46 and warranty information for any camera monitor system (CMS) from the bus OEM and/or the aftermarket supplier.

Considerations for the utilisation of Camera Monitoring System The use of camera monitor systems can be an effective solution to allow areas to the rear of the driver's eyes or specific blind spots in the forward field of view to be easily seen. However, experimental evidence has shown the ability of drivers to recognise hazards can be more difficult when reliant on indirect vision rather than via direct vision. The following should be considered when utilising indirect vision:

- **Image size:** Hazards seen in monitors are typically smaller than life size and their relative motion with the vehicle less easy to identify in peripheral vision. Thus, larger monitors may be preferable to smaller devices.
- **Conflicts with direct vision:** Monitors placed in areas around windows can cause some obstruction to direct vision. In this case smaller devices may be



considered preferable. However, compromises that position devices in places where direct vision is less important or where it coincides with existing less avoidable obstructions (e.g. A-pillars or driver assault screen frames) may be better, bearing in mind the possible recognition benefits of larger images.

- **Distortion:** Fish-eye camera lenses can produce very large fields of view from a single source, which can be seen as a benefit if the size of the field of view is all that is considered and not the quality of the image. They can however also distort the imagemaking it harder for drivers to recognise hazards and interpret risk particularly during quick mirror checks. Sophisticated software in some camera monitor systems may be able to enhance images in poor conditions such that image quality is higher than with equivalent mirrors.
- **Driver workload:** Evidence in HGVs suggests that scanning direct vision and up to 6 mirrors during a complex low speed manoeuvre takes a significant amount of time. This increases driver workload such that, although a hazard may more often be 'available to be seen', the driver may be looking in the right place at the right time less frequently, while still being diligently attentive and alert. Thus, indirect vision devices that add to driver workload by increasing the number of places they need to look or by requiring them to move their gaze further from the other areas they need to scan are likely to increase driver workload. This may detract from, or even reverse the other benefits that the devices provide.
- **Adjustment:** Poor adjustment can greatly reduce the useful available view from the device. Operators should request guidance from the OEM or aftermarket supplier regarding the correct adjustment of the CMS.

A wide range of differences in approach are still possible within these constraints and OEMs and operators should aim to select the best solutions they can bearing in mind these factors and their other operational constraints.

A camera monitor system which is intended to replace mirrors may resolve some of the potential conflicts by varying the views displayed on its monitors, depending on the vehicle and traffic situation at the time. For example, class II mirrors may be removed and replaced by a rectangular monitor mounted on each A-pillar. The camera system may also be capable of showing a class V close proximity side view and/or a rear view immediately behind the vehicle. When travelling forward at normal speeds the offside mirror may show the class II display only, the nearside may show a large class II display and a small class V display. At low speeds when indicators are activated this ratio may reverse such that a large class V view is displayed and a small class II. When reverse is selected perhaps both monitors may show a 50/50 class II and rear vision view. This approach has clear potential benefits but is a new technology and the workload requirements and effects on recognition are not clearly understood at this time. Such systems are well worth investigation but operators may wish to consider trialling them in pilot phases with objective feedback from drivers before widespread rollout.



3 Training

3.1 Bus drivers

Drivers should be trained to correctly adjust the CMS to provide the required field of view, in accordance with the guidance from the OEM or aftermarket supplier.

Where a monitor is used to meet the indirect vision requirements, drivers should be trained to understand the orientation and perspective of the image. In particular, where a camera monitor system replaces existing mirrors, drivers should be thoroughly familiarised with the system.

Further guidance on installation is to be provided when CMS HMI guidelines are produced.

3.2 Shift Supervisors

Supervisors should ensure drivers correctly adjust CMS to provide the required field of view and are familiar with the image provided by camera monitor systems.

4 Maintenance

Operators are encouraged to establish what (if any) daily checks are required, and to plan for these additional operational costs.

5 Repair

If during system maintenance checks (section 4) any of the cameras or monitors are deemed to be faulty or failing they should be replaced as soon as possible. The extent of the vision provided by the CMS is completely contingent on the cameras and monitors being clean and undamaged.

Training should be provided to mechanics/engineers on how to appropriately maintain and replace CMS systems.



Attachment 23: Rear view Camera Monitor Systems (CMS) Guidance Notes

1 Introduction

All buses shall allow the driver to have sufficient vision of their surroundings to allow the execution of all driving tasks required in service in London.

All buses shall have a high standard of direct and indirect vision in areas close to the vehicle where vulnerable road users are at particular risk of collision with a bus undertaking low speed manoeuvres. This is referred to as close proximity vision.

This document sets out the guidance notes related to the assessment of Direct and Indirect Vision, specifically in relation to rear-view camera monitor systems. These guidance notes are aimed at bus operators and OEMs as a practical guide for implementation of the Bus Safety Standard.

These notes are for guidance only, and are not legally binding. In all circumstances, the guidance provided by an OEM or system suppliers shall take precedence, and these guidance notes are only for use in the absence of other information. These are not intended to be exhaustive, but to point the operators toward practical advice and questions to raise with OEMs/suppliers.

2 Selection of buses/systems

Any bus that meets the TfL Bus Vehicle Specification.

The Direct and Indirect Vision requirements may be assessed against a new build bus, or against a vehicle fitted with an aftermarket retrofit rear-view camera monitor system.

2.1 Compliance and warranty

A bus operator should ask to see compliance certificates for UNECE Regulation 46 and warranty information for any rear-view camera monitor system (CMS) from the OEM and/or the aftermarket supplier. The compliance is with regard to the technical quality of view only.

2.2 Considerations for the utilisation of Rear View CMS

The use of camera monitor systems can be an effective solution to allow areas to the rear of the driver's eyes or specific blind spots in the forward field of view to be easily seen. However, experimental evidence has shown the ability of drivers to recognise hazards can be more difficult when reliant on indirect vision rather than via direct vision. The following should be considered when utilising indirect vision::



- **Image size:** Hazards seen in monitors are typically smaller than life size and their relative motion with the vehicle less easy to identify in peripheral vision. Thus, larger monitors may be preferable to smaller devices.
- **Conflicts with direct vision:** Monitors placed in areas around windows can cause some obstruction to direct vision. In this case smaller devices may be considered preferable. However, compromises that position devices in places where direct vision is less important or where it coincides with existing less avoidable obstructions (e.g. A-pillars or driver assault screen frames) may be better, bearing in mind the possible recognition benefits of larger images.
- **Distortion:** Fish-eye camera lenses can produce very large fields of view from a single source, which can be seen as a benefit if the size of the field of view is all that is considered and not the quality of the image. They can however also distort the image making it harder for drivers to recognise hazards and interpret risk particularly during quick mirror checks. Sophisticated software in some camera monitor systems may be able to enhance images in poor conditions such that image quality is higher than with equivalent mirrors.
- **Driver workload:** Evidence in HGVs suggests that scanning direct vision and up to 6 mirrors during a complex low speed manoeuvre takes a significant amount of time. This increases driver workload such that, although a hazard may more often be 'available to be seen', the driver may be looking in the right place at the right time less frequently, while still being diligently attentive and alert. Thus, indirect vision devices that add to driver workload by increasing the number of places they need to look or by requiring them to move their gaze further from the other areas they need to scan are likely to increase driver workload. This may detract from, or even reverse the other benefits that the devices provide.
- **Adjustment:** Poor adjustment can greatly reduce the useful available view from the device. Operators should request guidance from the OEM or aftermarket supplier regarding the correct adjustment of the CMS.

A wide range of differences in approach are still possible within these constraints and OEMs and operators should aim to select the best solutions they can bearing in mind these factors and their other operational constraints.

3 Training

3.1 Bus drivers

Drivers should be trained, whether necessary, to correctly adjust the rear-view CMS to provide the required field of view, in accordance with the guidance from the OEM or aftermarket supplier.

Where a monitor is used to meet the rear-view indirect vision requirements, drivers should be trained to understand the orientation and perspective of the image.

Further guidance on installation is to be provided when CMS HMI guidelines are produced.



3.2 Shift Supervisors

Supervisors should ensure drivers correctly adjust CMS to provide the required field of view and are familiar with the image provided by camera monitor systems.

4 Maintenance

Operators are encouraged to establish what (if any) daily checks are required, and to plan for these additional operational costs.

5 Repair

If during system maintenance checks (section 4) any of the cameras or monitors are deemed to be faulty or failing they should be replaced as soon as possible. The extent of the vision provided by the CMS is completely contingent on the cameras and monitors being clean and undamaged.

Training should be provided to mechanics/engineers on how to appropriately maintain and replace CMS systems.



Attachment 24: Blind Spot Warning (BSW) Assessment Protocol

1 Introduction

Blind Spot Warning (BSW) systems are used to provide additional information to drivers to inform them about the potential hazards presented by vulnerable road users in close proximity to the bus to support safe execution during low speed, driving tasks.

This document presents a procedure for objectively measuring the performance of Blind Spot information signal, Warning and intervention (BSW) systems.

For full understanding of this Attachment it should be read in conjunction with the Attachment 25: Blind Spot Warning (BSW) Guidance Notes and New Bus Specification, Section 4.3.9.

1.1 Scope

This protocol applies to all new buses intended for service under contract to TfL that are passenger vehicles with a maximum mass exceeding 5 tonnes and a capacity exceeding 22 passengers. The passenger vehicles will be capable of carrying seated but unrestrained occupants and standing occupants. Such vehicles are categorised in the Consolidated Resolution on the Construction of Vehicles (R.E.3) as M3; Class I, Class II.

Note, this standard is intended for application in the UK where vehicles drive on the left hand side of the road. However, application to regions where vehicles drive on the right hand side can be achieved by reflecting all scenarios and references to left and right about the longitudinal plane of the vehicle (global X-axis).

1.2 Purpose

The aim of the Blind spot warning assessment protocol is to provide objective assessments that can be used to enforce minimum standards for systems installed on vehicles to assist the driver and reduce the likelihood of collisions with vulnerable road users at low vehicle speeds. This protocol only covers collision situations related to low speed, close proximity manoeuvring. It does not consider forward collision warnings or automated emergency braking systems of the type relevant at higher speeds with the vehicle travelling in a straight line, such as those scenarios covered by TfL's AEB assessment protocol

Over many years blind spots in a driver's vision have been identified as a contributory factor in collisions between vehicles and pedestrians and cyclists which resulted in death or seriously injury. The Bus Vision Standard assessment (Attachment 19) has been defined to reduce likelihood of these type of collisions, however it is clear that better vision alone does not eliminate risk. Collisions where



pedestrians and cyclists are killed or seriously injured when positioned in close proximity to a moving bus do still occur, with specific collisions identified where the vehicle turned left and hit a vulnerable road user at the nearside or front.

Drivers must be attentive, looking in the right direction at the right time during potentially demanding driving situations and, having identified a potential collision, take the correct action. Blind spot information signal and collision warning systems therefore have a role to play in helping to ensure the driver pays attention to the presence of a pedestrian or cyclist in close proximity to a bus and assisting the driver with taking the correct action if a collision is imminent.

A regulation defining minimum standards for such systems is under development as part of a UN ECE Regulation. However, it will not initially be mandatory, may only apply to HGVs and not buses, will define a minimum pass/fail standard only and covers information signals and not necessarily collision warning or intervention systems.

2 Normative References

The following normative documents, in whole or in part, are referenced in this document and are indispensable for its correct application. For dated references only the edition cited applies. For undated references the latest edition of the referenced document (including any amendments) applies.

- London Bus Service Limited New Bus Specification Section 4.3.9
- London Bus Service Limited New Bus Specification - Attachment 25: Blind Spot warning guidance
- Directive 2007/46/EC of the European Parliament and of the Council establishing a framework for the approval of motor vehicles and their trailers, and of systems, components and separate technical units intended for such vehicles.
- Regulation (EU) 2018/858 of the European Parliament and of the Council of 30th May 2018 on the approval and market surveillance of motor vehicles and their trailers, and of systems, components and separate technical units intended for such vehicles, amending Regulations (EC) No 715/2007 and (EC) No 595/2009 and repealing Directive 2007/46/EC
- UN ECE Regulation 107 Uniform provisions concerning the approval of category M₂ or M₃ vehicles with regard to their general construction
- Euro NCAP Test Protocol AEB VRU Systems Version 2.0.1 August 2017
- Articulated Pedestrian Target Specification document version 1.0.
- Bicyclist Target Specification document version 1.0.
- UN ECE Regulation 10. Uniform provisions concerning the approval of vehicles with regard to electromagnetic compatibility
- BS EN 50498:2010 Electromagnetic compatibility (EMC). Product family standard for aftermarket electronic equipment in vehicles.



- ISO 11452-9 'Component test methods for electrical disturbances from narrowband radiated electromagnetic energy - Part 9: Portable transmitters'
- ISO 11451-3 'Vehicle test methods for electrical disturbances from narrowband radiated electromagnetic energy – Part 3: On Board Transmitter Simulation'
- UN ECE Regulation 61 Uniform provisions on the external projections of commercial vehicles
- Commission Regulation (EU) No 1230/2012 implementing Regulation (EC) No 661/2009 of the European Parliament and of the Council with regard to type-approval requirements for masses and dimensions of motor vehicles and their trailers and amending Directive 2007/46/EC of the European Parliament and of the Council.
- ISO 612:1978 Road Vehicles – Dimensions of motor vehicles and towed vehicles – terms and definitions.
- ISO 15006: 2011. Ergonomic aspects of transport information and control systems – specifications for in-vehicle auditory presentation
- ISO 15008: 2009. Road vehicle – Ergonomics aspects of transport information and control systems – Specification and test procedure for in-vehicle visual presentation
- ISO 15998:2008 Earth moving machinery – Machine control systems (MCS) using electronic components – performance criteria and tests for functional safety
- ISO 16001: 2008. Earth moving machinery. Object detection systems and visibility aids
- ISO 15037-2: 2006: *Road Vehicles – Vehicle dynamics test methods - General conditions for heavy vehicles and buses*
- ISO 19206: Road vehicles. Test devices for target vehicles, vulnerable road users and other objects for assessment of active safety systems

3 Definitions

For the purpose of this Protocol:

- **Accelerator Heel Point (AHP)** - A point on the shoe located at the intersection of the heel of shoe and the depressed floor covering, when the shoe tool is properly positioned. (Essentially, with the ball of the foot contacting the lateral centre line of the undepressed accelerator pedal, while the bottom of the shoe is maintained on the pedal plane). As defined in SAE J1516, SAE J1517 and SAE J1100.
- **Approval Authority** - The body within TfL that certifies that a bus is approved for use in the TfL fleet and assigns its score under the bus safety standard for use in procurement processes.
- **Aftermarket system** - A BSW system that is fitted to the vehicle after it has been registered and delivered for the first time, by agencies other than the OEM or their authorised dealer.



- **Blind spot** - The volume of space around the vehicle under test that cannot be seen by the driver either through the glazed areas of the vehicle cab or through the indirect vision devices installed on the vehicle.
- **Blind Spot information signal, Warning and intervention (BSW) system** - A complete system, encompassing both the defined blind spot safety functions and enabling technologies, that informs the driver of a VRU in close proximity to the vehicle, warns the driver of an imminent collision with a VRU and/or intervenes directly with the drive controls to prevent a collision.
- **Blind spot safety function** – These functions are defined by the action that the enabling technologies take to either improve the chances of a driver acting appropriately should a VRU be in the vehicle blind spot or to automatically avoid a collision should the driver fail to take the appropriate action. They include:
 - a) **VRU proximity information signal** - A signal informing the driver that a VRU has been detected in close proximity to the vehicle. A proximity information signal (which may be referred to as an information signal), is a medium urgency signal that reflects the fact that the driver may or may not be aware of the presence of the VRU and that there may or may not be an imminent risk of collision.
 - b) **VRU collision warning signal** - A signal issued to the driver where an imminent collision between the VRU and the vehicle is calculated as likely. Such a system shall not warn the driver of the simple presence of a VRU in close proximity. A collision warning is a high urgency signal that warns the driver of the vehicle that a collision is imminent.
 - c) **Motion inhibit** - A system that prevents a vehicle from moving off from rest when a VRU is located in front of the vehicle and is at risk of an imminent collision. The system may achieve the function through intervention in throttle, gear selection, braking, or other means. The system shall be type approved for use by the OEM.
- **Dealer fit system** – A BSW system that is fitted as a standard component to the vehicle after production (i.e. not integrated in the original vehicle design). However, the installation of the device is approved by the OEM and fitted by its authorised dealers prior to delivery and registration.
- **Enabling technologies** - The technologies that enable the blind spot safety function through the combination of sensor components, decision-making algorithms and the components utilised to implement the blind spot safety function. Sensor and vehicle components may be used for multiple purposes (e.g. cameras may also be used by camera monitoring systems replacing external mirrors or for CCTV recording purposes) or a single function may require more than one sensing technology (e.g. the use of both camera and RADAR sensors in a process known as sensor fusion).
- **Human Machine Interface (HMI)** - The part of a BSW system that interacts with the driver and includes controls and settings for activating or adjusting the application as well as the means by which information and warning signals are communicated from the system to the driver.



- **Horizontal field of view angle** - The angle between the longitudinal plane of the vehicle under test and the sightline
- **OEM: Original Equipment Manufacturer** – The company responsible for the manufacture of a complete bus, delivered to a bus operator
- **OEM system** - A BSW system that is integrated into the design of the vehicle and is fitted in the factory.
- **Motion inhibit over-ride** - A manual over-ride function that, when applied, deactivates the motion inhibit blind spot safety function
- **RADAR** - Radio detection and ranging. A sensor component that uses radio waves to detect the range and positions of objects.
- **Reference eye point** - A point representing the centre point of the driver's left and right eyes and offset from the AHP by [678]mm in the X axis and [1163.25]mm in the Z axis. This is the point from which the sightline originates.
- **Signal** - The transmission of an identifiable alert to a bus driver through the HMI notifying them to the hazards that may be caused by the interaction of their vehicle with a VRU. Signals may be transmitted to the driver by the HMI through a number of different signal modes.
- **Signal mode** - The method of transmitting a signal to a driver and consisting of four key modes including: audible (tonal), audible (speech), visual or haptic.
- **Sightline** - A line parallel to the XY plane that passes through the reference eye point and is angled according to a specified horizontal field of view angle
- **Standardised environmental clutter** - The minimum set of roadside furniture (described below), that is positioned to simulate a realistic environment that has the potential to affect the performance of the sensors often used for the enabling technology.
 - a) **Advertising hoarding** - A standard advertising hoarding with overall dimensions measuring approximately 2 m tall by 1 m wide. A proportionally scaled image of the Euro NCAP adult pedestrian dummy shall be displayed on the advertising hoarding (Figure 24_1). The image shall be positioned such that the dummy faces towards the trajectory of the VUT. The image and sign shall be positioned such that the lower edge of the dummies feet is as close to the ground as possible and no more than 200 mm from the ground.



Figure 24_1: Example of the standard advertising hoarding and image

- b) **Traffic sign** - A 30mph speed limit sign complying with the C14 standard of the Vienna Convention on Road Signs and Signals. It shall be mounted on a pole such that the lowest point of the sign shall be located 2 m vertically above the test track surface.
- c) **Railing** - A typical city kerbside railing that shall be simulated using temporary crowd control barriers, an example of which is shown in Figure 24_2. These shall be constructed from a metal easily detected by RADAR. The height of the barrier shall be approximately 1.1m height. The diameter of the vertical rail shall be no less than 10 mm. Vertical rails approximately 125 mm apart. The feet of the railing may extend laterally towards the Kerb but shall not exceed 200mm from the centre-line of the railing.



Figure 24_2: Example of a temporary metal crowd control railing

- **Test Service** - The organisation undertaking the testing and certification of the results to the Approval Authority.
- **Test Target** - A test dummy that accurately represents the characteristics of the relevant VRU, as seen by the relevant sensing technologies used by BSW. A range of specific test targets are:
 - a) **EBT: Euro NCAP Bicyclist and bike Target** - Means the bicyclist and bike target as specified in the Euro NCAP Bicyclist Target Specification document version 1.0.



- b) **EPTa: Euro NCAP Adult Pedestrian Target** - Means the adult pedestrian target as specified in the Euro NCAP Articulated Pedestrian Target Specification document version 1.0.
 - c) **EPTc: Euro NCAP Child Pedestrian Target** - Means the child pedestrian target as specified in the Euro NCAP Articulated Pedestrian Target Specification document version 1.0.
- **Time to Collision (TTC)** - The time it would take for the vehicle to reach the point of collision if the speed and trajectory of the vehicle remained constant when calculated at any instant in time. At constant vehicle speeds, the TTC will always reduce over time. If speed is reduced, however, TTC increases and if sufficient braking is applied to avoid a collision then the TTC tends towards infinity.
- **Vehicle length:** The distance in the x-axis between two points located at the foremost and rearmost aspect of the vehicle and measured in accordance with the definition contained in Commission Regulation (EU) no 1230/2012, when excluding the following components:
 - a) Wiper and washer devices
 - b) Front or rear marker-plates
 - c) Lighting and light signalling devices
 - d) Mirrors or other devices for indirect vision
 - e) Watching and detection aids including RADAR
 - f) Access ramps, retractable steps and lift platforms etc.
 - g) Coupling and recovery towing devices for power driven vehicles
 - h) Trolleybus current collection devices
 - i) De-mountable spoilers
 - j) Exhaust pipes
- **Vehicle Under Test (VUT)** - Means the vehicle being assessed according to this protocol.
- **Vehicle width:** The distance in the y-axis at the widest point of the vehicle and measured in accordance with the definition contained in Commission Regulation (EU) no 1230/2012, when excluding the following components:
 - a) Mirrors or other devices for indirect vision
 - b) Bulge in the tyre at the point of contact with the road
 - c) Tyre failure tell-tale devices and pressure indicators
 - d) Side marker lamps, service door lighting and other side mounted lamps and retroreflectors
 - e) Access ramps, retractable steps and lift platforms etc.
 - f) Watching and detection aids including RADAR
 - g) Flexible mudguards
 - h) Snow chains

- **Vulnerable Road Users (VRU):** Means pedestrians or cyclists.

4 Reference system

4.1 Local co-ordinates

A local co-ordinate system (x,y,z) for the VUT shall be defined such that the x -axis points toward the front of the bus, the y -axis towards the left and the z -axis upwards, as shown in Figure 24_3.

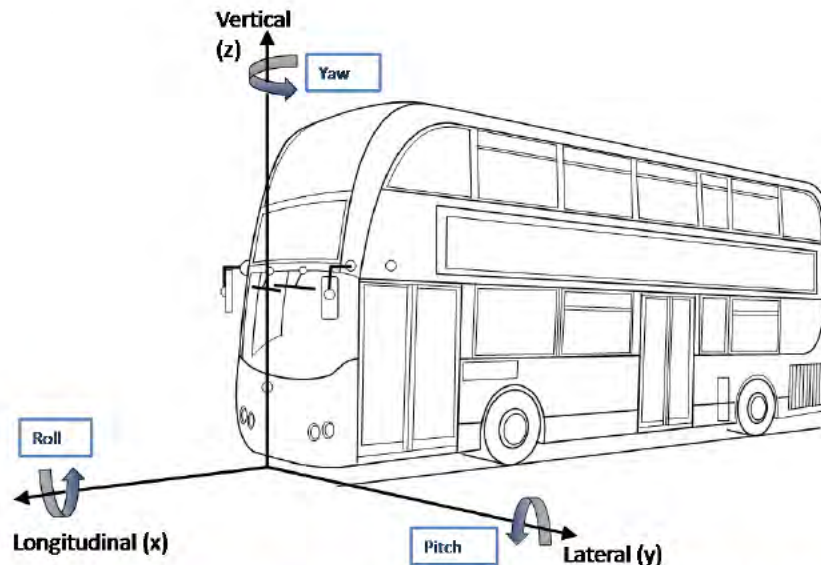

Figure 24_3: Local coordinate system and notation for VUT

4.2 Global co-ordinates

A global co-ordinate system (X, Y, Z) fixed relative to the Earth shall be defined such that the global X -axis is coincident with the local x -axis of the vehicle in its initial starting position. Thus, a VRU travelling perpendicular to the initial direction of the VUT would be travelling along the global Y -axis.

4.3 Test Target coordinates

The local coordinate systems (x,y,z) for the EPTa and EPTc test targets shall both be defined such that the x -axis points in the direction of walking, the y -axis towards the left and the z -axis upwards. The origin of the coordinate system shall lie on the ground plane, at the intersection of the test target centreline and a line perpendicular to the centreline passing through the test target hip point, as shown in Figure 24_4.



Figure 24_4: Origin of local coordinate systems for EPTa and EPTc test targets, illustrating centrelines (grey), local coordinate system origin (red) and test target hip point (orange),

The local coordinate systems (x,y,z) for the EBT test target shall be defined such that the x-axis points in the direction of travel, the y-axis towards the left and the z-axis upwards. The origin of the coordinate system shall lie on the ground plane, at the centre of the bottom bracket of the test target bicycle, as shown in Figure 24_5.

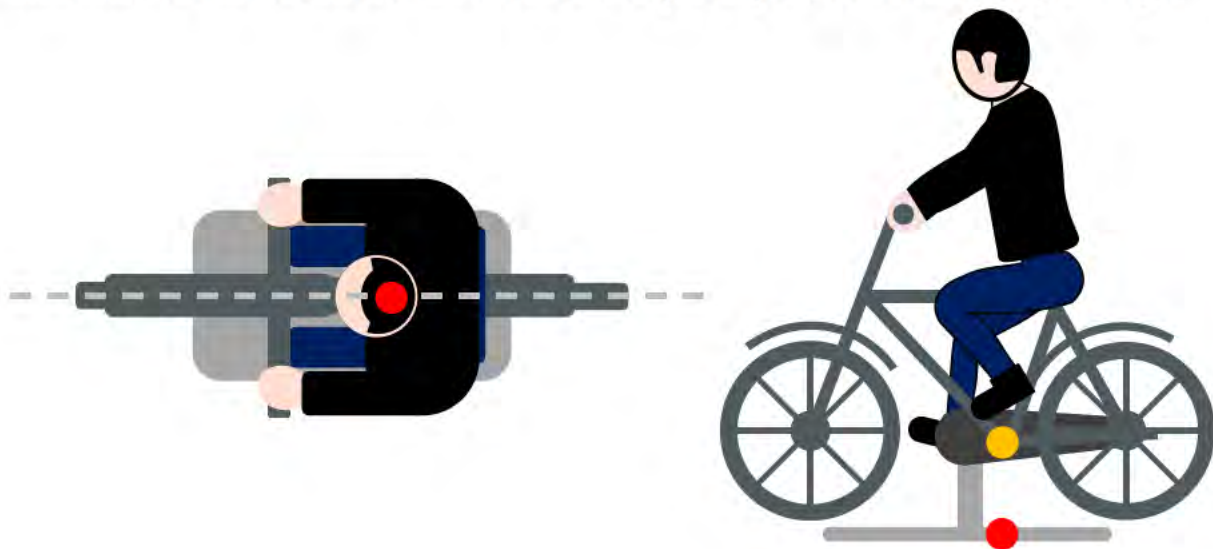

Figure 24_5: Origin of local coordinate systems for EBT test target, illustrating test target centreline (grey), local coordinate system origin (red) and centre of the bottom bracket (orange)

5 Measurements and variables

5.1 Variables to be measured

The variables which shall be measured continuously throughout testing can be seen in Table 24_1, along with the minimum operating ranges and measurement accuracy required.

Table 24_1: Variables to be measured continuously during testing with minimum operating ranges and maximum overall permitted measurement errors

Variable	Operating range (at least)	Measurement accuracy
----------	-------------------------------	-------------------------



Position (global coordinates) of vehicle under test (VUT_x, VUT_y)	200m in X-axis 100m in Y-axis	$\pm 0.03\text{m}$
Position (global coordinates) of VRU test target (VRU_x, VRU_y)	200m in X-axis 100m in Y-axis	$\pm 0.05\text{m}$
Speed of vehicle under test (V_{VUT})	0mph to 20mph	0.1mph
Speed of VRU test target (V_{TT})	0mph to 12.5mph	0.1mph
Heading (yaw) angle (θ) relative to global X-axis (θ_{TV}, θ_{TT})	0° to 360°	0.1°
Longitudinal acceleration of vehicle under test (A_{VUT})	$\pm 15\text{m/s}^2$	0.1m/s^2

Additional variables which shall be measured on a periodic basis, both before each test and at least every 30 minutes during testing, can be seen in Table 24_2, along with minimum operating ranges and maximum overall permitted measurement errors.

Table 24_2: Variables to be measured periodically during testing with minimum operating ranges and maximum overall permitted measurement errors

Variable	Operating range (at least)	Measurement accuracy
Ambient Temperature	-5°C to $+50^\circ\text{C}$	$\pm 1^\circ\text{C}$
Wind Speed	0m/s to 20m/s	$\pm 0.2\text{m/s}$
Ambient Illumination	0lux to 150,000lux	$\pm 10\%$

5.2 Measuring equipment

Details of the sensors used to measure the required variables shall be recorded in the test report together with the position in which they are installed within the vehicle (measured relative to the local co-ordinate system for the VUT).

The default equipment to be used shall be a high-quality inertial navigation system in combination with differential GPS with data recorded at a sample rate of at least 100 Hz, which has been found to provide all continuously measured variables with sufficient accuracy. With such equipment, post-sampling digital filtering shall be as follows:

- a) Position and speed need no additional digital filtering after data capture;
- b) Acceleration and yaw rate shall be filtered with a phaseless digital filter complying with the requirements of ISO 15037-2:2002.

Alternatively, any measuring equipment that can be demonstrated to be compliant with the requirements of ISO 15037-2:2002 is permitted.



In addition to the data recording described above, the VUT shall be equipped with one or more video cameras positioned such that for each and every test, the TT can be clearly seen at the moment of impact, at impact points ranging from 1% to 99% of the vehicle width. When conducting test the video feed shall be synchronised to the data recordings, with a delay of less than 50ms. This camera footage is intended for engineering use only in order to provide a visual reference to allow cross-checking of post-processed data. Camera mounting position, lens type etc. are not considered important for this purpose provided impact position or timing of avoidance can clearly be seen in the resulting footage.

6 Test Conditions

6.1 Test Track

Tests shall be undertaken on a uniform, solid-paved surface with a consistent slope in any direction of between 0% and 1%. The surface must be paved and may not contain any irregularities (e.g. large dips or cracks, manhole covers or reflective studs) that may give rise to abnormal sensor measurements within a lateral distance of 3.0m to either side of the test path and within a longitudinal distance of 30m ahead of the VUT when the test ends.

6.2 Surroundings

Conduct testing such that only the Standardised Environmental Clutter specified in the particular test procedure is present within a lateral distance of 6.0m on the left side and 4.0m on the right side of the VUT path, and within a longitudinal distance of 30m ahead of the VUT when the test ends.

No other vehicles, highway furniture, obstructions, other objects or persons protruding above the test surface that may give rise to abnormal sensor measurements are permitted in this area. Lane markings are permitted but not required.

The VUT must not pass under overhead signs, bridges, gantries or other significant structures during the test.

The general view ahead and to either side of the test area shall comprise of a wholly plain manmade or natural environment (e.g. further test surface, plain coloured fencing or hoardings, natural vegetation or sky etc.) and must not comprise any highly reflective surfaces or contain any vehicle-like silhouettes that may give rise to abnormal sensor measurements.

6.3 Weather Conditions

Tests shall be undertaken only in compliance with the following weather conditions:

- a) Ambient temperatures shall be between 0°C and 45°C
- b) No precipitation shall be falling during testing. The surface is permitted to be damp during testing but the quantity of water present on the surface must be less than the amount liable to cause splash or spray during the test.
- c) Horizontal visibility at ground level shall be greater than 0.5 miles.
- d) Wind speeds shall be below 6m/s average, gusting to 10m/s.



- e) Natural ambient illumination must be homogenous in the test area and in excess of 2000 lux with no strong shadows cast across the test area other than those caused by the VUT, VRU or standardised environmental clutter. Tests shall not be undertaken in such conditions that visual sensors are adversely affected by direct sunlight. However, if it is found that such conditions exist, it shall be recorded in the test report.

6.4 Test Targets

Pedestrian test targets shall be the EPTa and EPTc and the cyclist test target shall be the EBT. The relevant VRU test targets shall be moved around the test area and delivered to the point of impact with the VUT by a low-profile platform.

The system will be capable of moving the vulnerable road user at speeds of up to at least 12.5mph, to accelerate at 3 m/s^2 or more, and maintaining constant speed within a tolerance of 0.25mph. Lateral deviation from an intended straight path shall be no more than 0.05m.

The platform may be self-propelled or moved by a pulley system. However, in either case any visible parts of the combined platform and VRU mounting system shall be of a uniform colour that blends well with the test track beneath it. The default colour is grey.

The platform and VRU mounting system shall not influence RADAR return and RADAR absorbing material may be used at the VRU mounting points to ensure compliance with this requirement.

The distance between the lower edge of the VRU and the road surface shall be less than 75 mm.

7 Vehicle preparation

7.1 Aftermarket systems

For aftermarket systems, the system shall be installed on a standard VUT of category M₃ with the following characteristics:

- a) Overall Length: 9.5 to 11 metres
- b) Number of axles: 2
- c) Axle configuration: 1 front (steered), 1 rear

Where considering the approval of aftermarket systems on vehicles that are different to this specification in terms of length, number of axles or steering configuration, then testing with the relevant VUT shall be required to guarantee satisfactory performance.

7.2 OEM systems

For an OEM system, the rating shall apply to the vehicle as a whole and any other models that share the same critical properties. Thus, the VUT will be whatever vehicle is supplied by the OEM for test, with this recorded in the Test Report.

7.3 Dealer fit systems



Dealer fit systems may be tested either as integrated systems for the vehicle or as aftermarket systems fitted to a standard vehicle. The choice shall be recorded in the Test Report.

7.4 Blind Spot Safety System

7.4.1 Installation

The blind spot safety system to be tested shall be installed on the VUT in accordance with the manufacturer's instructions.

Each blind spot safety system may enable more than one blind spot safety function. Suppliers may market such systems with a variety of optional configurations, including additional functions outside of the scope of this document. The exact configuration of the system tested must be recorded in the Test Report.

It is permitted to install multiple blind spot safety systems on the vehicle. This may arise where multiple separate systems, for example from different suppliers, are installed on the same VUT for reasons of increased efficiency. In this case, it must be ensured that no conflict, that has the potential to affect results, occurs between systems in terms of the location and field of view of the sensors, the potential for one sensor to interfere with another or the location of the user interface within the vehicle.

7.4.2 Settings

Some systems may incorporate driver configurable settings. Where those settings can influence performance, for example the sensitivity of proximity information signal or collision warnings, they shall be set to the middle setting (midpoint), or where this is not possible to the next latest possible setting. Examples are illustrated in Table 24_3, where a setting that would tend to make an information signal or warning later is one that would reduce the range or sensitivity of the application, whilst earlier would tend to make the application more sensitive or to detect at longer range.

Table 24_3: Blind spot safety system setting for testing

	Setting 1		Setting 2		
Early	Setting 1	Setting 2		Setting 3	Late
	Setting 1	Setting 2	Setting 3	Setting 4	

In this way, a system with only two settings gets adjusted to the least sensitive setting, or latest intervention, a system with 3 possible settings gets adjusted to the midpoint and a system with four settings gets adjusted to the sensitivity setting below the midpoint.

7.5 Tyres

Perform the testing with road legal tyres of the size, speed and load rating specified by the vehicle manufacturer. Inflate tyres to the pressures recommended by the OEM for the least laden normal condition (unladen or lightly laden). Tyre pressures immediately before the test shall be recorded in the Test Report.



7.6 Vehicle under test, Mass

BSW shall be operative at all states of Load.

VUT shall be tested and assessed unladen with only the driver and test equipment on board.

Each axle of the vehicle shall be weighed in the condition as tested and the measurements recorded in the test report.

All test equipment installed in the vehicle should be securely attached such that it cannot move under maximum braking forces.

8 Test scenarios

This section describes the methods for testing the performance of blind spot system functions. The overall approach taken is to consider tests relating to two different key collision scenarios: where a bus moves off from rest and where the bus is in motion. Within each collision scenario, more than one specific test method may be defined to fully assess the blind spot system performance in that collision scenario. The method of evaluating the specific results of each individual test and assessment are presented across this section. In all conditions, the accelerator pedal should be depressed to 100% travel, excluding any kick-down limit switches.

8.1 Moving-Off Scenarios

8.1.1 General Test Scenario Configuration

The general test scenario configuration is designed to be representative of collisions where a pedestrian walks in front of a stationary bus in an urban area. The driver moves the bus off from rest, without seeing the VRU in front of the vehicle, resulting in a collision. Representative VUT and VRU test target starting positions and intended motions are illustrated in Figure 24_6, alongside positioning information for the standardised environmental clutter.

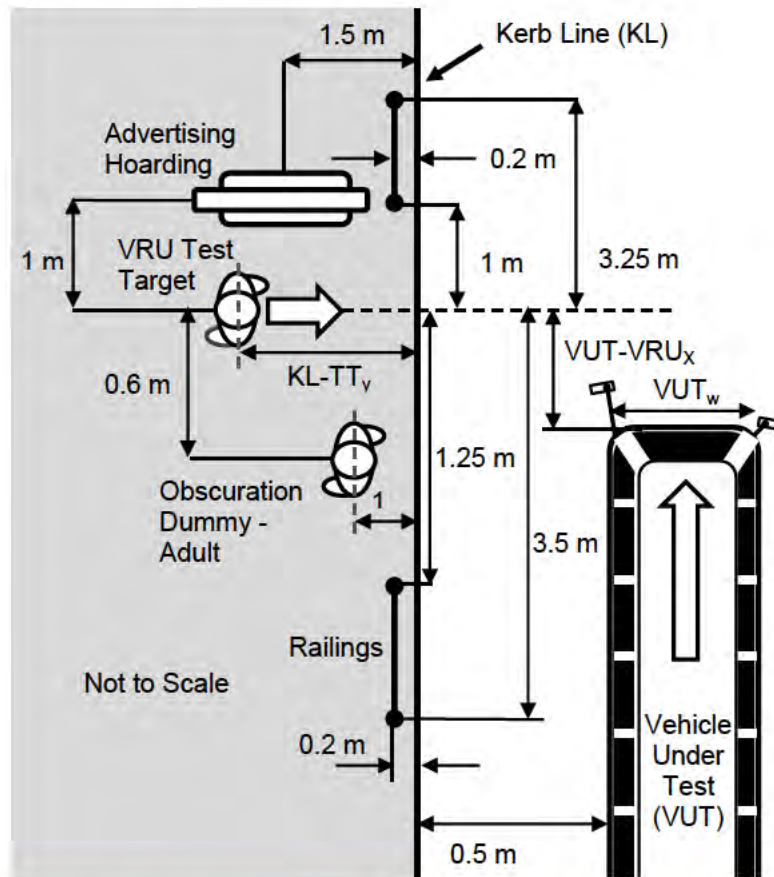

Figure 24_6: General test configuration for vehicle under test (VUT), test target (VRU) and standardised environmental clutter positions at time T_0 with intended motions for moving-off test scenarios

All test scenario configuration dimensions illustrated in Figure 24_6. Fixed dimensions are enumerated, whilst dimensions that vary with each test scenario are described by their acronym:

- a) Vehicle under test width (VUT_w)
- b) Kerb Line (KL) is a line parallel to the global X-axis defining the nominal kerb edge of the road
- c) Lateral distance from nearside edge of VUT to KL = 0.5m
- d) Lateral distance from KL to centreline of VRU ($KL-TT_y$)
- e) Longitudinal distance from front of VUT to centreline of VRU ($VUT-TT_x$)
- f) Lateral distance from KL to Obscuration Dummy centreline = 1m
- g) Longitudinal distance from centreline of VRU to centreline of Obscuration Dummy = 0.6m
- h) Lateral distance from KL to centreline of railings = 0.2m
- i) Longitudinal distance from VRU centreline to leading edge of foremost railing = 3.25m
- j) Longitudinal distance from VRU centreline to trailing edge of foremost railing = 1m



- k) Longitudinal distance from VRU centreline to leading edge of rearmost railing = 1.25m
- l) Longitudinal distance from VRU centreline to trailing edge of rearmost railing = 2.5m
- m) Lateral distance from Kerb Line to centreline of Advertising hoarding = 1.5m
- n) Longitudinal distance from VRU centreline to centreline of Advertising Hoarding = 1m

8.1.2 Moving-Off Proximity Information signal (MOPI) Scenario

This test assesses the ability of a system to detect a pedestrian manoeuvring around the front end of a stationary bus and provide an effective VRU proximity information signal. The VUT, test targets and standardised environmental clutter shall be set up as specified in Section 8.1.1 with additional test scenario specific parameters as detailed in Table 24_4.

Table 24_4: Definition of test scenario specific parameters for the Moving-Off Proximity Information signal (MOPI) scenario

Parameter	Test Scenario		
	Adult Close (True Positive)	Child Mid (True Positive)	Adult Far (False Positive)
KL-TT _Y	1.2m	1.2m	1.2m
VUT-TT _X	0.3m	[2.5]m	[4.0]m
VRU Test Target	EPTa	EPTc	EPTa
VRU Speed (V _{TTy})	2 mph ± 0.5mph	3.2mph ± 0.5mph	3.2 mph ± 0.5mph

For all test scenarios, a constant acceleration of $1 \text{ m/s}^2 \pm 0.2 \text{ m/s}^2$ (A_{TTy}) shall be applied to the VRU test target in the direction of the negative Y-axis until the steady state VRU speed (V_{TTy}) is met, at which A_{TTy} shall drop to a nominal acceleration of 0 m/s^2 where the steady state speed shall be maintained constant until the VRU has completely passed the front of the VUT.

The VUT ignition shall be switched to the fully on position with the vehicle gear/Drive selected and parking brake off, as if ready to move off. The VUT speed in both the x-axis and y-axis (V_{VUTx} , V_{VUTy}) shall be maintained at 0 mph through all test scenarios.

The motion of the VUT and VRU are enumerated below:

- a) $A_{TTy} = 1 \text{ m/s}^2 \pm 0.2 \text{ m/s}^2$ until V_{TTy} is reached, thereafter nominally 0 m/s^2 .
- b) $V_{VUTx} = V_{VUTy} = 0 \text{ mph}$.

The start of each test (T_0) shall be taken as the point where the acceleration (A_{TTy}) is first applied to the VRU test target.

The completion of each test (T_1) shall be taken as the point at which no part of the VRU test target remains in the path of the VUT, defined as if the VUT moved purely in the x-axis.



The status of the blind spot information and warning signals shall be recorded, along with VRU test target position, from time T_0-1 second to T_1 . The evaluation distance shall be taken as the difference between the VRU test target positions at T_0 and T_1 .

Each specified test scenario shall be undertaken once.

8.1.3 Moving-Off collision Warning and motion Inhibit (MOWI) Scenario

This test assesses the ability of a system to detect a pedestrian located in the path of a bus moving off from rest and either intervene to inhibit the motion of the bus or to provide an effective VRU collision warning signal.

The VUT, test targets and standardised environmental clutter shall be set up as specified in Section 8.1.1 with additional test scenario specific parameters as detailed in Table 24_5.

VRU test targets shall be positioned directly in front of the VUT at lateral positions, 25%, 50%, and 75% of the width of the VUT (i.e. $0.25 \cdot VUT_w$, $0.5 \cdot VUT_w$, $0.75 \cdot VUT_w$ at $0.25 \cdot VUT_w$ intervals).

Table 24_5: Definition of test scenario specific parameters for the Moving-Off collision Warning and motion Inhibit (MOWI) scenario

Parameter	Test Scenario		
	EPTa Close (Motion Inhibit)	EPTc Close (Motion Inhibit)	EPTa Far (Motion Inhibit or Collision Warning)
VUT- TT_Y (% VUT _w)	25%, 50%, 75%	25%, 50%, 75%	25%, 50%, 75%
VUT- TT_X	0.3m	0.3m	[4.0]m
VRU Test Target	EPTa	EPTc	EPTc

VRU test target speeds in the x-axis and y-axis (V_{TTx} , V_{TTY}) shall be maintained at 0 mph throughout all test scenarios.

The VUT shall be driven such that it pulls away from rest in the x-axis and towards the VRU test target, before braking to a stop, using the following procedure:

- a) Select an appropriate forward gear
- b) Release park brake
- c) Fully depress accelerator
- d) Accelerate to no more than 10mph

The start of each test (T_0) shall be taken as the point where the VUT accelerator pedal is first depressed.

The completion of each test (T_1) shall be taken as either the point at which the VUT motion inhibit function is activated or the point at which contact with the VRU is made.