

# Big Red Book

Fifth Edition

MAYOR OF LONDON



**TRANSPORT  
FOR LONDON**  
EVERY JOURNEY MATTERS

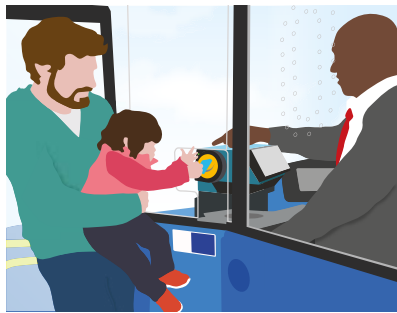

Fifth edition ©2019  
For staff use only

# Contents

- 06 Welcome to the Big Red Book
- 08 What's changed?
- 12 London's professional bus drivers
- 68 London's safe bus drivers
- 82 London's accessible bus network
- 110 Support for London's bus drivers
- 136 London bus driver's guide to tickets and passes
- 178 Further helpful information



447

High Street





## Welcome to the Big Red Book

I am delighted to introduce the latest edition of the Big Red Book.

As Director of Bus Operations, I would like to take this opportunity to thank you for everything you do to make our bus network a success. We know it's a success from the growing number of happy customers and the increase in commendations we receive year-on-year, despite the many operational challenges you face every day. Since 2014, the number of commendations has more than doubled from 1,557 to 3,571 in 2018.

Across all areas of public transport, customers should expect a good travel experience and, often, it's the small things that make a big difference. Between 2016 and 2018, Transport for London (TfL) and London's bus operators have invested in every London bus driver by providing ground-breaking training to improve and enhance our customers' experience. Called 'Hello London', it has been the most successful course ever offered to bus staff, with 94 per cent of drivers saying they thoroughly enjoyed it, found it impactful and would recommend it to others.

As you know, our customers tell us about our bus service all the time and many of their comments are about you – the people on the frontline of the services we deliver. Following the training, you have told us you feel more empowered to provide a good customer experience and it is clear this has had a positive impact on your day-to-day role. The amount of great feedback we receive about

London's bus staff increases each month, and that is down to you and the amazing work you do every day.

We also listened to what you said during the training and we have incorporated many of your ideas and suggestions in our customer campaigns and in this new edition of the Big Red Book. Please continue to tell us what you think – it is very important to me (see page 11 for details of how to contact us).

As we all continue to work together to eliminate injuries and deaths on London's roads, the most important challenge facing us is to meet our Vision Zero aim of no one killed on or by a London bus by 2030. I believe together we can achieve this target. We will be working with you to further develop our Bus Safety Programme and ensure that you receive all the training and support you need to make our bus network safer for you, our customers and the public.

Thank you and keep up the good work!



A handwritten signature in black ink that reads "Claire Mann".

**Claire Mann**

Director of Bus Operations, Surface Transport  
Transport for London



## What's changed?

Most of the policy information in your new Big Red Book remains unchanged and much of it, such as what a customer can take on a bus, is based on UK-wide Public Service Vehicle (PSV) Regulations or UK law.

We have listened to your suggestions and requests and, where possible, have updated the advice and guidance in the book. Unfortunately, we can't cover everything so, if you're in doubt about how to deal with a situation, think about how you would like to be treated. This will usually give you the answer.

Most of your trips will be trouble-free but, on occasion, things can happen. **To get the best help in the best way in any emergency, remember your ABCDs:**

### A: Assess the situation

You will need to let others, such as the Network Management Control Centre (NMCC), know what is going on. To assess the situation, ask yourself:

- What has happened?
- What is happening now?
- What seems to be the problem/situation?
- Where are you?
- How many people are involved?





## B: Be safe

It is important that you and your customers are kept safe. Ask yourself:

- Where is the safest place for me and my customers?

## C: Call for help

When you are safe and secure, you need to get the best help and advice.

- If 'safe' is on the bus – call **Code Red** (keep the button pressed for at least two seconds to connect to NMCC and press the footswitch to speak)
- If 'safe' is 50 metres away from the bus – call **Code Red** from another bus or the emergency services on 999

## D: Do as advised

Listen to what NMCC/the emergency services have to say (they are the experts) and do as they advise.

While many of you will have been briefed to remember your ABCDs in a security situation, they also apply in a range of other instances. For example, they can be used if a customer falls on a bus or reports unwanted sexual attention, or if a confused or worried customer remains on your bus at the end of a trip.



As the London bus network is changing, we have removed the bus service guide from the Big Red Book. This will be available separately.

We've also added or changed information on the following topics:

Remember your ABCDs	Page 8
Serving the stop	Pages 19 – 27
Buggies	Pages 42 – 45
Pre-recorded announcements	Pages 60 – 61
Using the PA system	Pages 62 – 66
Vision Zero and London's Bus Safety Programme	Pages 74 – 78
Customers with invisible disabilities	Page 87
Please offer me a seat badge and card	Page 94
Who can use the ramp on buses?	Page 95
Wheelchairs, mobility scooters and mobility walkers	Pages 96 – 108
Mobility Aid card	Pages 106 – 107



Pre-loaded SMS text messages on iBus	Pages 122 – 123
Should the worst happen	Pages 126 – 129
Security and terrorism awareness	Pages 130 – 134
Hopper fare	Page 140
Vulnerable customers	Page 140
Police travel	Pages 159 – 161
Further helpful information	Pages 178 – 197

Get in touch and we'll get back to you. You can:

Text your questions to: **07860 023 080\***

Email: **[busdriverfeedback@tfl.gov.uk](mailto:busdriverfeedback@tfl.gov.uk)**

\*Your normal network rate applies

# London's professional bus drivers

- 15 A typical journey
- 32 If your journey is diverted or disrupted
- 37 What can you allow on board?
- 42 Buggies
- 46 Using your Electronic Ticket Machine
- 53 Using your Mobile Data Terminal
- 60 Pre-recorded announcements
- 62 Using the PA system





## London's professional bus drivers

As a professional driver, you may have many routine tasks to carry out that are essential for making sure our customers have a safe and reliable journey, every time they use our service. How you complete these tasks and the effort you put in, will make a huge difference to their experience.

Some customers are still frustrated at not being able to get on or off the bus when they want to. Often, customers tell us they were left behind at a bus stop in different situations, or not let off the bus when they were waiting by the middle doors. It is a misunderstanding that leads to a large number of complaints every year, so we need to resolve this issue. Once we do, we are likely to see even more commendations (for full details on correctly serving bus stops, see pages 19 – 27).

Take pride in your contribution to the communities you serve and make sure every journey is as good as it can be.

## A typical journey

### Before you leave the garage

- 1 Complete your walk-around checks in line with your company's procedures. Make sure your bells are working, including the blue 'wheelchair' bell, and do the same for your accessibility ramp which should be fully lowered (as shown) with audio/visual alerts fully operational. If there is any problem with the bells or ramp you must report it. Your bus should be repaired or substituted before you leave the garage.

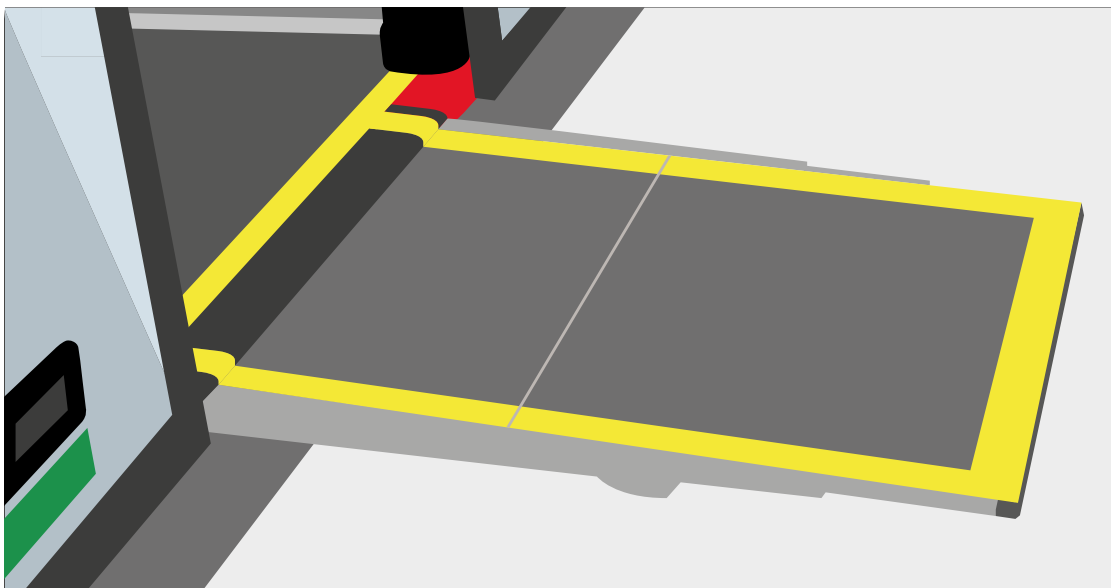



- 2 If your company still uses electronic ticket machine (ETM) modules, remember to sign it on and check your ticketing equipment is working. Otherwise, sign onto your ETM using your four-digit PIN. If it is not, report any faults as soon as possible. For more details, see pages 46 – 52.
- 3 You also need to make sure your iBus and Mobile Data Terminal (MDT) are working. Visual and audio announcements on iBus make it much easier for all customers, especially disabled customers and those less familiar with the network, to use buses so it must be switched on at all times. The only exception is if you are authorised not to do so by your service controller because, for example, the direction of travel is not correctly updating.

Having iBus on also means customers will ask you fewer questions. Please report any faults as soon as possible via your service controller so we can get them fixed.

- 4 You should be smartly dressed in your company's uniform to promote a professional image. You must not wear your hi-vis jacket while driving, but you should put it on when required in vehicle movement areas, to make sure you stay safe.





## On the road

- 1 Always drive with the safety and comfort of your customers and other road users in mind.
- 2 You must not eat, smoke (including electronic cigarettes), vape, use an electronic device (including a mobile phone) or listen to headphones or a radio while driving or in charge of the bus. You may drink liquids to stay hydrated when your vehicle is stationary and the handbrake is applied.
- 3 Do not chat to anyone (including colleagues) or allow yourself to be distracted while driving. If a customer asks you a question, explain that you will answer when you have stopped.
- 4 Make sure all the destination blinds on your bus are set correctly and are easy to read for each journey. If it is dark, the blinds must be lit. This will be automatic on most new buses, when the side and headlights are switched on. Please check before the start of your trip – if the lights are not working, report this to your garage.

When you are running out of service, your destination blinds should be set to 'Not in service'.

- 5 Keep your dashboard clean and clear.



See On the road, points 4 and 5 on page 17.



See Serving the stop, point 2 on pages 19 – 20.



## Serving the stop

### 1 Stop when someone has pressed the bell or asked to get off at the next stop.

- When approaching a stop, check if anyone has indicated that they wish to get off. They would usually press the bell, but they might ask
- Stop within the bus stop road markings unless there is a valid reason not to, such as roadworks or parked vehicles
- Stop close enough to the kerb so customers can get off easily. Lower the bus if this will help
- Position the bus so you can safely extend the accessibility ramp if needed

### 2 Stop if anyone is waiting at the bus stop, making sure you check the area.

- Stop at any stop on your route if someone is waiting by, sitting down or has signalled to you
- Slow down while approaching the stop to check there are no customers waiting
- If there is any doubt, stop
- Look out for older and disabled customers, especially blind and partially sighted people. Remember that not all impairments or conditions can be seen



- Also, look out for wheelchair or mobility scooter users and acknowledge that you have seen them. Keep the front doors closed on two-door buses, so they are given priority access. For more details, see page 98
- At the stop, call out your route and destination to anyone who looks unsure. Lower the bus if it could help a customer, or if they ask. Advise the customer you may have to shut the doors before lowering the bus
- Give people the opportunity to board and only leave when you are sure there is no one else waiting

### **3 Look for people making an effort to get to the bus and older or disabled customers, especially on low-frequency routes.**

- Only move away when you have checked no one else wishes to board
- Be prepared to wait for customers, including people making an effort to get to the bus stop; vulnerable customers, including older or disabled people; and customers on low-frequency routes who would have a long wait for the next bus
- Do not close the doors until all customers are on board or the bus is full



#### **4 Do not re-open the doors if you have indicated to leave the stop or another vehicle has given way to you.**

- If it is safe to do so, you may re-open the doors up until you start to indicate, or another road user gives way
- Do not let people board the bus once it has pulled away from the stop, for example, at traffic lights

#### **5 Be prepared to stop twice if there is a long line of buses, unless you are sure no one wants to get on your bus.**

- Join the end of the queue. Allow people to get off at that point if it is safe to do so and let any new customers board the bus
- If it is not safe, tell customers they will be allowed off when you can pull up to a safe position
- Once at the stop, allow all customers to board
- Always assume you will have to stop again at the flag, unless you can see the whole stop and are sure no one else is waiting for your bus
- Older or disabled customers may not be able to come to the bus. Look out for them and remember that not all impairments or conditions can be seen

## 6 When a customer has boarded the bus, take extra care before departing.

- Before moving off, make sure all customers who boarded are sitting down or holding on safely
- This is especially important for those who are older, disabled or with young children. Remember, not all impairments or conditions can be seen so give everybody enough time

## 7 Make the most of available space on busy services.

- Use the pre-recorded announcement, '**Please move down inside the bus**', to ask customers to move and follow up with a public address (PA) announcement if more encouragement is needed
- On double-deck buses, use the pre-recorded announcement, '**Seats are available on the upper deck**', to encourage customers to go upstairs and make space for others





## 8 If the bus is full, slow down when approaching a stop.

- If your bus is full and you drive past a stop at speed while customers are waiting, they may think they have been ignored when there was space on the bus
- On busy services, if you have tried to get customers to move and have reached your legally permitted total number, drive slowly past the next stop so waiting customers can see the bus is full. This will ensure they understand that they have not been ignored

## 9 Letting people off the bus between stops.

- If there is a long delay, such as roadworks or a collision, you can allow customers off the bus between stops, provided it is safe to do so
- Use the pre-recorded announcement on your PA system, '**The driver will open the doors as soon as it is safe to do so**', to explain when it is and is not safe to be let off between stops
- Explain to wheelchair or mobility scooter users why it may be difficult for them to be let off between stops
- Wherever possible, only allow customers off from the front doors in these situations
- If you know the reason, let customers know why the bus is delayed



## 10 Be aware of closed stops on your route.

- Stay informed of bus stop closures and diversions on your route, provided through notices of events and service controller instructions
- Do not pick up customers or allow them to get off at closed bus stops. Politely inform anyone waiting that the stop is closed by pointing to the hood on the bus stop flag. Indicate that you will not be able to stop
- Stop at temporary 'dolly' stops, where they are provided to replace the usual stop
- Tell customers about closures or diversions at the stop before you get there, using the pre-recorded announcement
- Provide further details and alternative options using your PA system
- At the first safe opportunity, which may be before or after the stop, use the PA system to explain unexpected closures. Apologise and explain that the stop is closed because it is not safe to use and the bus will continue to the next safe stopping location
- Notify NMCC of any stops that appear unnecessarily shut
- If you are on a diversion, serve all stops along the diverted route (see page 32)



## Stop closure

Bus stops can be closed because of:

- Planned roadworks
- Emergency roadworks
- Pavement works
- Building works (such as scaffolding)
- New shelter installations
- Safety reasons



When bus stop closure hoods are in place, customer information will usually be posted in the timetable frame to explain why.

Sometimes, it may not be obvious to drivers (or customers) why the stop is closed. For safety reasons, you should not serve any stop with a bus stop closure hood in place.

If in doubt, or you think a stop should be re-opened, call **Code Blue**.



### Planned closure

This hood is placed on a stop to advise customers that it may not be in use for selected periods.

This could be because of an overnight closure (for road resurfacing, for instance), short-term events or sports events (for example, the London Marathon).

As with the stop closure hood, customer information will be posted in the timetable frame.



Drivers should serve any stops with this hood as normal before and after the period of planned closure. Refer to the Notice of Event for full details of the planned closure.

### Rail replacement stops

Certain bus stops will be used by buses during rail replacement work. All scheduled services should continue to serve these stops as normal.





## **11 On Hail and Ride sections, where the customer is waiting.**

- Look out for customers using Hail and Ride services and stop in a safe position as close as possible to them
- Indicate to customers waiting at unsafe locations that you will stop as close as is safely possible, for instance by pointing to where you will stop, and wait to collect them
- Stop as close as is safely possible to where customers ask to get off or press the bell
- Inform customers why they are being let off somewhere else when you cannot stop at their preferred location

Note: We continue to work with local authorities and other interested groups to reduce Hail and Ride sections and replace them with fixed stops, where possible.

## **12 If in doubt, stop the bus.**

- Remain professional and be patient when dealing with the situations listed previously
- This will help customers feel valued and more confident about travelling on London's buses



### When you are at a bus stand

You must switch off your engine. Leaving it running wastes fuel, is a noise nuisance, damages health and is an offence. London borough officers may also issue you with an on-the-spot penalty fine.

- Check for any customers remaining on your bus as you do your walk-around checks. If customers are present, politely ask them to leave unless:
  - They appear to be lost, vulnerable or distressed. Reassure the customer(s) that you will call for assistance (remember your ABCDs – see page 8)
  - You do not feel comfortable about the situation. Stay in your cab and call **Code Red** immediately, or go to a safe place and call the emergency services on 999

### When you are at a bus station

- Keep to the speed limit
- Switch off your engine as soon as you can
- Wear your hi-vis jacket in and around vehicle movement areas. It should be worn with the reflective side showing
- Walk on designated walkways
- Smoke (including electronic cigarettes) or vape in authorised areas only; don't set a bad example to others
- Report spillages, collisions or damaged surfaces to TfL staff



- Comply with requests from the bus station controller
- Be considerate to other bus drivers, for example, by moving your bus forward on larger stands
- If you are terminating or curtailed in the bus station, check your vehicle for customers. If you unintentionally bring a customer into the bus station, please escort them to a safe place
- When entering or leaving bus stations, look out for pedestrians who may be crossing



## Questions from customers

If you are asked a question along the lines of 'What is the number of the bus?' or 'Where does this bus go?', please answer in a polite and helpful way. Remember, not all impairments or conditions can be seen – think how you would like to be treated in this situation.

## Checking tickets

- I If an Oyster or contactless card (or mobile electronic device loaded with pay as you go credit) is used, listen for the beeps and check the information on your ticket machine.

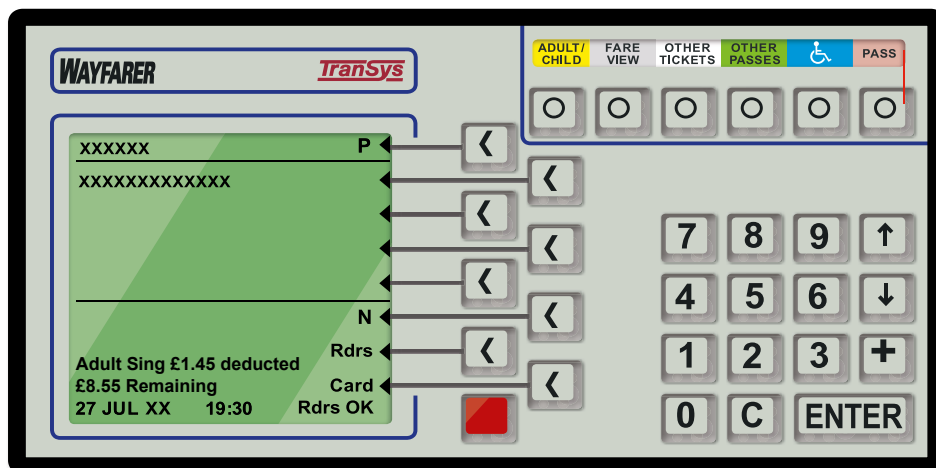

- 2 If you are shown a printed ticket, you should check for the following:



For full details about tickets and cards accepted on London's bus network, including contactless payment using mobile electronic devices, see pages 136 – 165.

## If your journey is diverted or disrupted

### Diversions

- 1 Check at the garage for any planned diversions at the start of your duty and make sure you are familiar with the revised route. For unplanned diversions during service, always contact your service controller and follow their instructions. If you are unsure where to go, use your ABCDs (see page 8) and call NMCC using **Code Red**.
- 2 For both planned and unplanned diversions, you must tell your customers what is going on. Use the PA system to keep them informed. Do not rely on iBus as we are not always able to update the on-board next-stop information, especially if it is an unplanned or short-term diversion. For help with using the PA system, including which button to press, what to say and when to say it, see page 62.
- 3 On diversions, you must serve all bus stops if customers want to get on or off. Where there are multiple stops, stop once where you can get close enough to the kerb so customers can get on or off easily.





### Diversion boards

Boards will be sited near junctions where services have to deviate from the usual route.

These diversions are normally planned in advance and notices will be posted at garages.

Boards will often show route numbers.

They will also be sited for unplanned diversions/emergency closures once the diversion routes have been authorised.

NMCC will usually transmit diversion details in advance of boards being sited.



### Rail replacement boards

These boards are placed to guide drivers on rail replacement services, many of whom will be unfamiliar with the area.

They are not diversion boards and scheduled services should ignore directional information displayed.





### If your bus breaks down or is curtailed

- 1 Use the pre-recorded announcement '**The destination of this bus has changed**'.
- 2 Use the PA system to apologise and tell your customers you will help them on their way as soon as possible.
- 3 Remind customers who have used pay as you go that the Hopper fare allows them to make unlimited journeys for one single fare when they change buses within one hour of touching in on the first bus.



- 4 Make sure all customers are transferred to another bus. Look out for disabled customers, or those who may need extra help (such as older people or tourists). Remember, not all impairments or conditions can be seen, so never make assumptions.

For more help on which button to press and what to say over the PA system, see page 62.





### Transfer tickets

The ability to issue transfer tickets will end when the printer is removed from your ETM, which will happen during the lifetime of this Big Red Book. Look out for driver notices.

Following the introduction of the Hopper fare, customers who have used pay as you go can make unlimited journeys for one single fare when they change buses within one hour of touching in on the first bus. Anyone who asks for a transfer ticket should be politely reminded about the Hopper fare.

## What can you allow on board?

### Say yes to:

- 1 Guide dogs (including puppy walkers who are training new guide dogs) and other assistance dogs (helping for example, autistic people, those with epilepsy or another disability). You must allow them on board, and there is no limit to the number of assistance dogs you can accept (see pages 90 – 91).

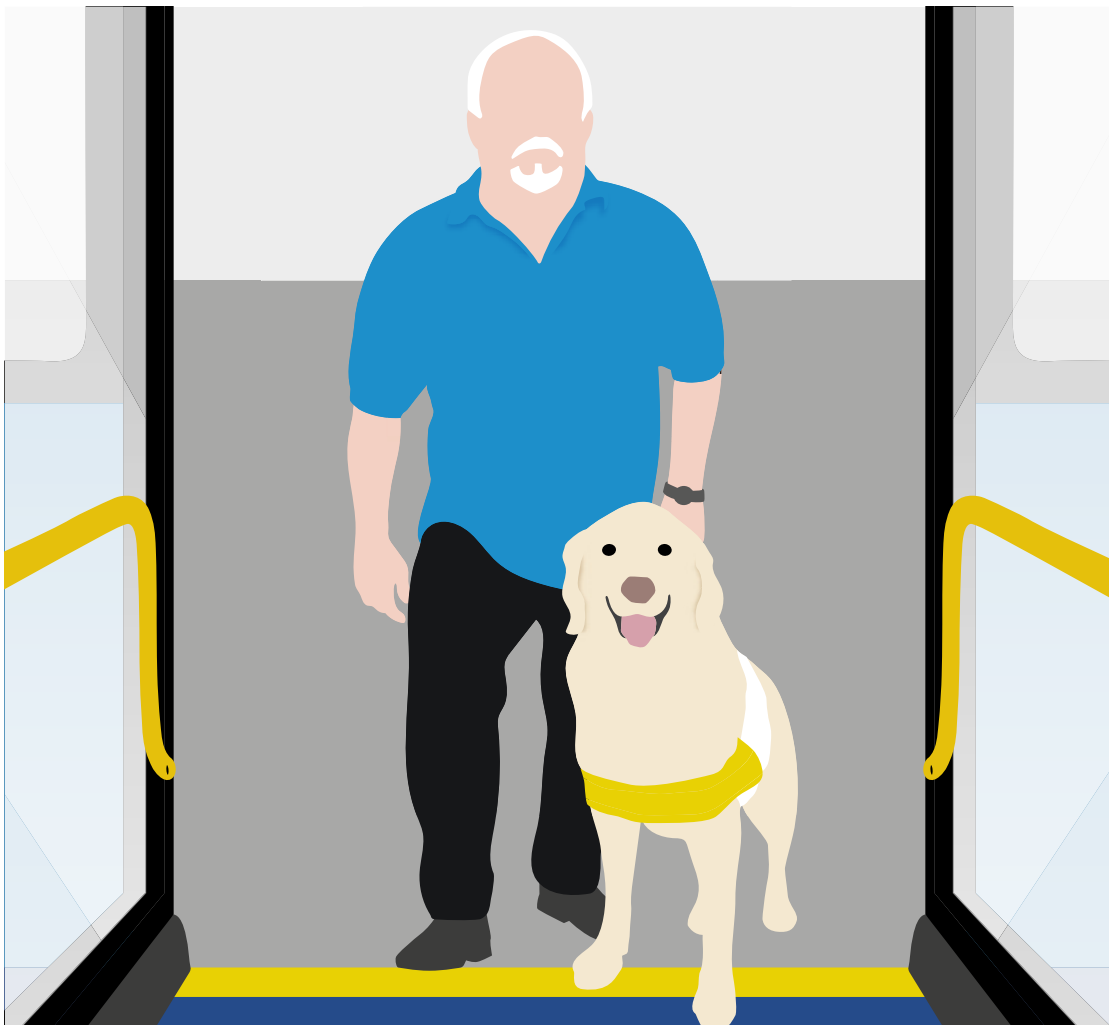



**Say yes to:**

- 2 Other dogs and inoffensive animals (such as cats or other domestic pets in a carrier) – only refuse them if they are aggressive. Use your discretion if you are asked to carry more than one per deck, especially if you have an assistance dog on board. Dogs should be under control and on a lead and should not occupy a seat. All dogs may travel on any deck of the bus.



**Say yes to:**

- 3 Bicycles and scooters that fold up and can be carried on to the bus. These can be allowed on the bus where they should be placed in the luggage rack or behind seats.



- 4 Small oxygen cylinders, which customers may need for medical reasons.



**Say no to:**

- 1 Open bottles or cans of alcohol.
- 2 Open containers or those leaking fluid, such as open tins of paint or food containers.
- 3 Anything hazardous or inflammable, such as petrol cans.
- 4 Unfolded bicycles.
- 5 Other items including:
  - Objects more than two metres long
  - Anything one customer cannot carry by themselves
  - Anything likely to cause injury or offence
  - Electronic cigarettes being used on the bus

If you decide you cannot allow something on board, apologise and politely explain why.







## Buggies

We know that, sometimes, the number of people wanting to travel on your bus with buggies can be difficult to manage. The following guidelines are designed to help you cope with these situations at busy times.

Customers with single buggies should board by the front door only. However, if they wish to board by the middle door because their buggy is too large, they must ask your permission first. Users will still need to touch their Oyster/contactless card or show you a valid ticket.

### When there is more than one buggy

- I It is safe to have up to **two** unfolded buggies in the wheelchair priority area, when there is no wheelchair or mobility scooter user in the space.

If you have been told there is a wheelchair or mobility scooter user waiting at a stop further along the route, it would be good practice to tell both buggy owners that they should be prepared to move, share or fold their buggy when the wheelchair or mobility scooter user wishes to board the bus. Other buggy owners wishing to board should only be allowed on the bus if they are prepared to fold their buggy.

On some buses, generally single deck vehicles, there is another area where one small unfolded buggy can be parked.

- 
- 2** Often, a wheelchair or mobility scooter user and an unfolded buggy can share the priority area. It would be helpful to explain this to the customers concerned, as they will be happier and will feel more in control of the situation. You should allow this provided the wheelchair or mobility scooter user is in the correct position (against the padded back rest), is happy to share the space and the buggy does not block the gangway.
  - 3** Ask customers to move or fold their buggy if there is not enough space for an unfolded buggy to share the priority area with a wheelchair or mobility scooter user, or if it will cause an obstruction. Do not move off until they are safely repositioned.

See page I06 for further details about the mobility aid card and how this can be used by customers who have adapted buggies for disabled children.



### Dealing with double or large single buggies

Customers with these types of buggies can board by the middle doors, as it may be too difficult for them to get on at the front. Customers must ask your permission first and will still need to touch their Oyster/contactless card or show you a valid ticket.

If customers ask why they need your permission to board, politely explain the following reasons:

- There may be another buggy owner who was at the stop first, boarding by the front door
- They may block the aisle of the bus if the priority area is already full
- There may be a wheelchair or mobility scooter user waiting at a stop further along the route and you need to keep the priority area free for them
- They may become trapped if you are unaware a buggy owner is boarding through the middle doors, when these are closed



## Using your Electronic Ticket Machine

It is important you log on to your Electronic Ticket Machine (ETM) correctly using the details on your duty card. This ensures your journeys can be tracked and appear on customer Countdown signs, as well as the live bus departures website/mobile phone apps.

### Wireless operation with no module

#### Signing on to the ticket machine

##### Idle screen

- Press **ENTER** to begin signing on



### Driver sign-on screen

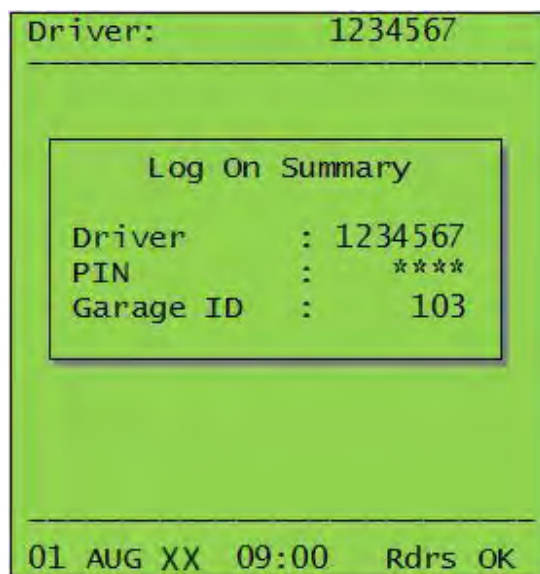

- Enter your seven-digit driver number and four-digit driver PIN followed by **ENTER**
- Key in the Garage ID number followed by **ENTER**
- Key in answers to questions on the screen, pressing **ENTER** after every answer
- For 'Checked Bus' and 'Route Number' use **↑** and **↓** to show correct details

**(Note – 'Checked Bus' only appears at some garages)**



- Wait until the ETM checks the data with iBus
- You may also need to sign on to the MDT as well (see page 53)

**You must check your ETM and card reader are working before leaving the garage**

### Running light

Before running light, remember to log off the MDT by pressing the 'log off' key and confirming log off.

### End of trip

At the last stop the ETM screen will show details of the next trip.

- If the details are correct, press **ENTER**
- If the details are not correct, press **C**, then key in the correct route and trip details. If you need to change other details perform Driver Sign Off



## Driver functions menu

### Driver sign-off screen

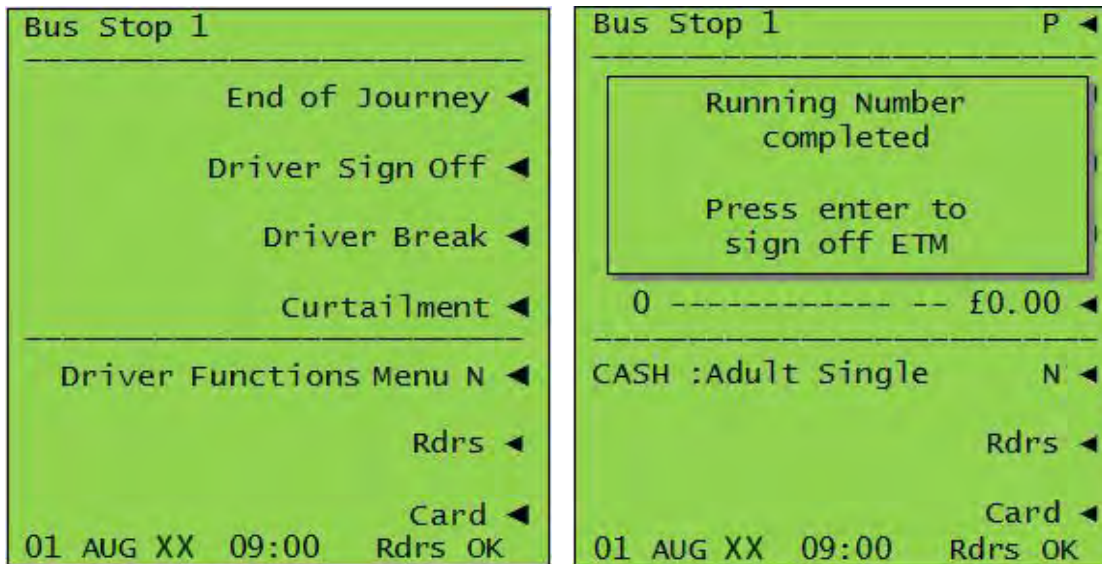

- At the end of your driving spell press Driver Sign Off followed by **ENTER** to sign-off the ETM
- If this is the last trip for the running number, press **ENTER** when back at the garage to sign-off the ETM

## Driver break screen

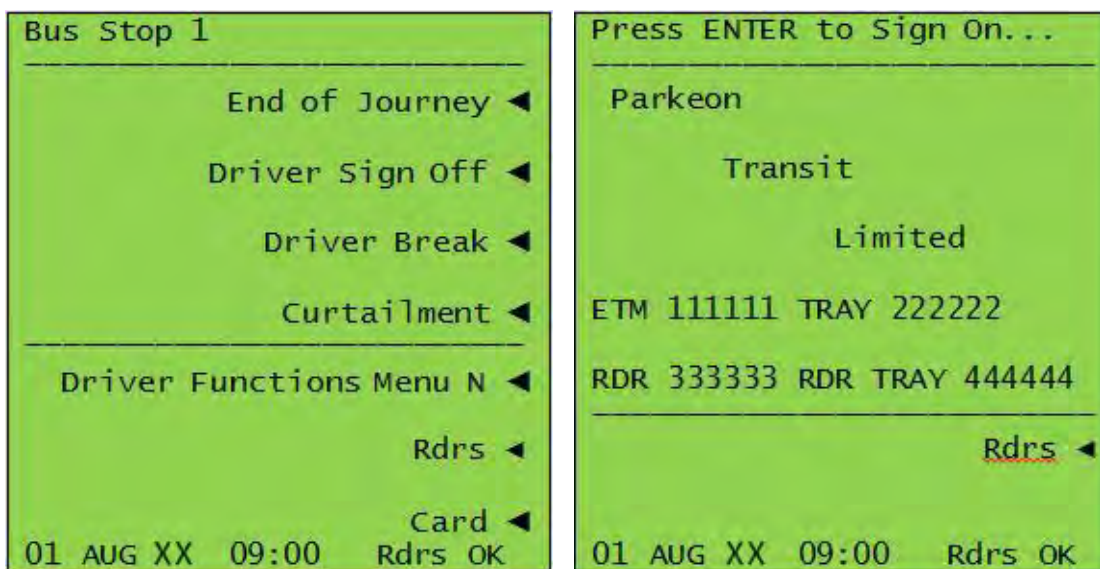

- If you are going on a break press Driver Break to lock the ETM until you return
- To return from Driver Break key in your four-digit driver PIN followed by **ENTER**
- If the ETM is already in Driver Break from a previous driver, when you start your duty, you must press **C** followed by **ENTER** to sign-off the previous driver
- If necessary, sign on separately to the MDT (see page 53)

## Traditional operation with a separate ticket machine module

(This type of operation will be gradually phased-out during 2019)

### Signing on driver module at the garage

- Insert module in Garage Terminal
- Key-in your seven-digit driver number, press **ENTER**
- Wait for the beeps, then remove module

### Signing on to the ETM

- Insert module in ETM
- Key in answers to questions on the screen, pressing **ENTER** after every answer
- For 'Checked Bus' and 'Route Number' use **↑** and **↓** to show correct details

### (Note – 'Checked Bus' only appears at some garages)

- Wait until the ETM checks the data with iBus
- You may also need to sign on to the MDT as well (see page 53)



## End of a trip/driving spell/duty

### End of a trip

At the last stop, the ETM screen will show details of the next trip.

- If details are correct: press **ENTER**
- If details are not correct: press **C**, then key in the correct route and trip details. If you need to change other details remove and re-insert the module
- If necessary, sign on separately to the MDT, as shown on page 53

Details of the trip may appear on the ETM again later. If they do, check and accept or change them as above.

### End of a driving spell

- Remove module, take waybill

### End of duty

At garage:

- Insert module in garage terminal
- Key in your seven-digit driver number, press **ENTER**

Wait for beeps, take paying-in slip, then remove module.

## Using your Mobile Data Terminal

Make sure your Mobile Data Terminal (MDT) logs on at the same time as your ETM. It is important you log on to your ETM correctly using the details on your duty card. This ensures your journeys can be tracked and can appear on customer Countdown signs, as well as the live bus departures website and mobile phone apps.

If you need to sign on to the MDT separately from the ETM, enter your details as below:

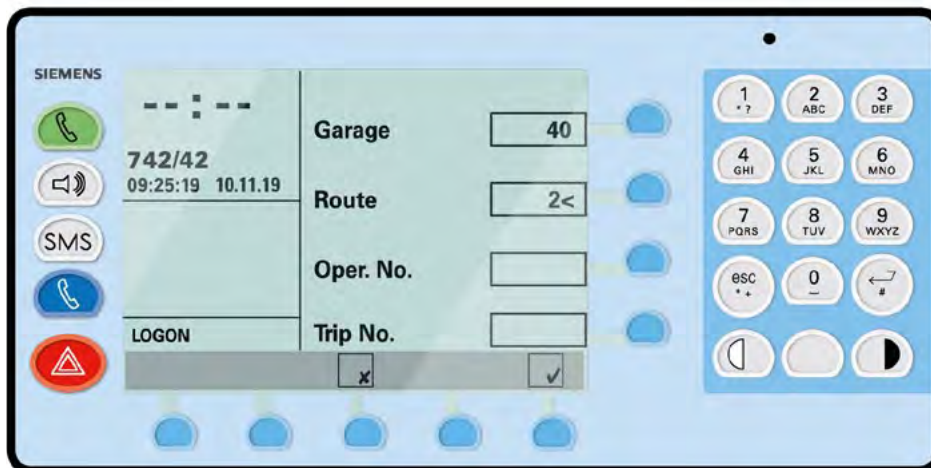

Remember, when you are running out of service to/from the garage, you must log off from your MDT to ensure the mileage is recorded correctly and your bus does not appear on customer Countdown signs and the live departures website.



You may also need to use the following process to ensure your MDT is fully operational and you have proper radio communications with your garage:

- 1 Enter a route variant.

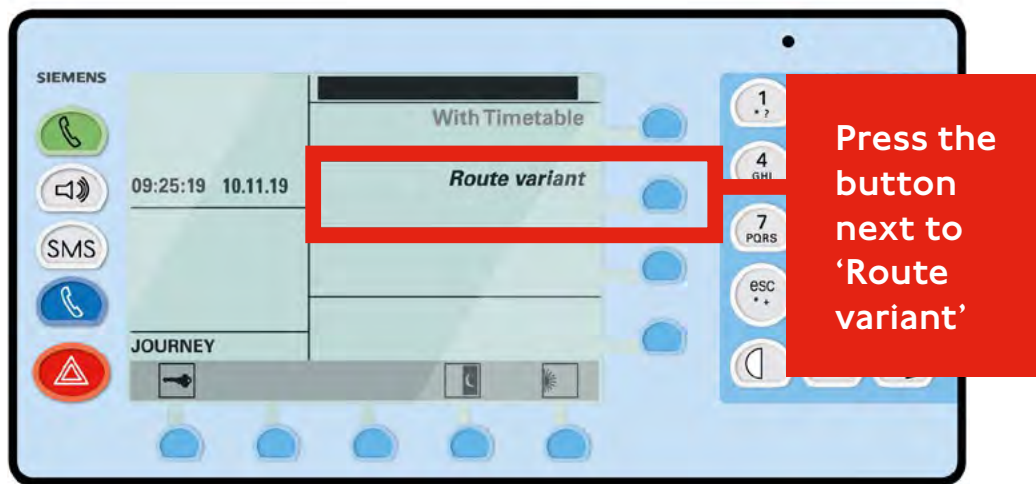

- 2 Select where your journey starts and where it ends.

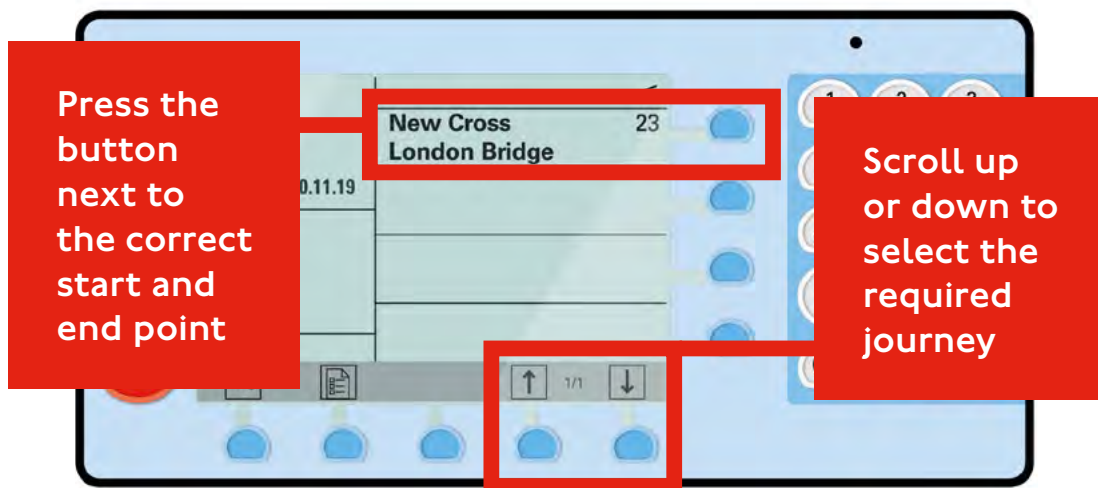

- 3 Do the same when you enter the details for your return trip.

### Driver-entered curtailments

If you need to enter a curtailment, follow the steps below (after a short while you will see a confirmation screen):

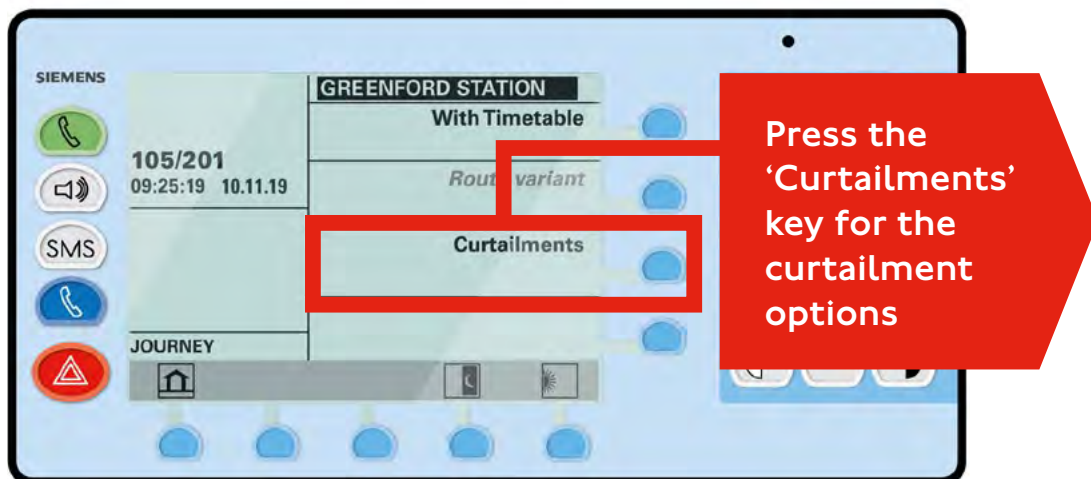
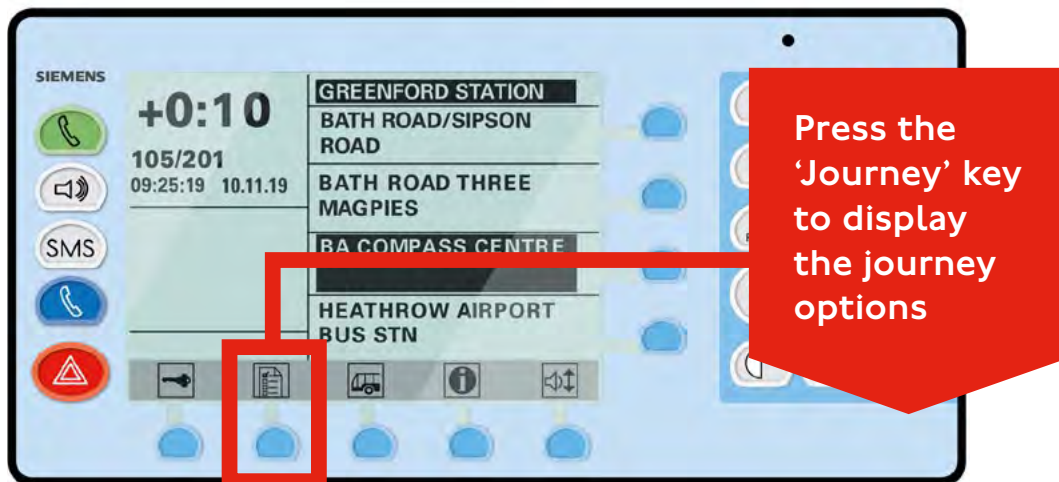

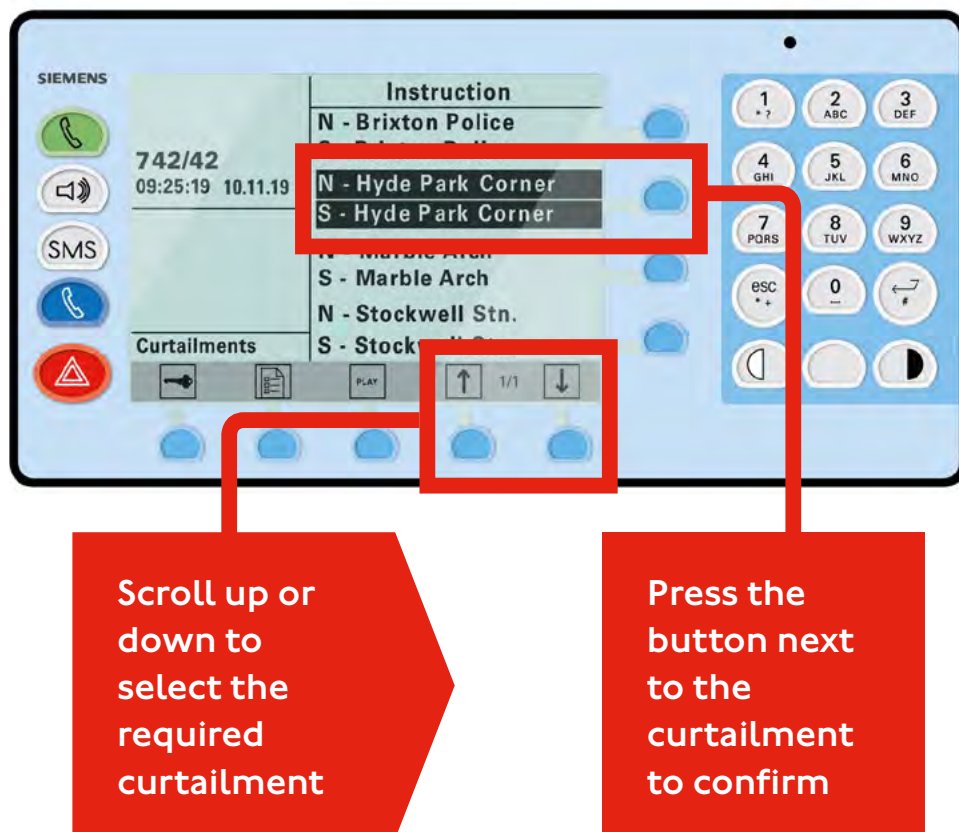

- Acknowledge the instruction by pressing the button below  or select the button below  as shown on page 57, if there is a mistake and the service controller needs to reset the instruction for you
- When acknowledged, the destination announcement will change
- It would be helpful to make a PA announcement to tell your customers what is happening (see pages 62 – 66)



## Curtailements by a service controller

These are shown to you as an instruction (and the authorisation code will be given over the radio).

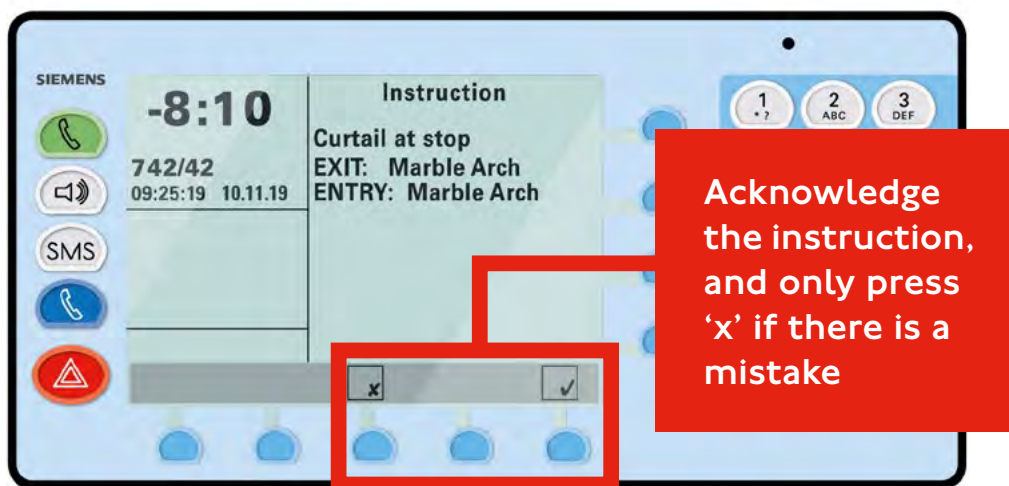

- It would be helpful to make a PA announcement to tell your customers what is happening (see pages 62 – 66)



### Using pre-recorded announcements

For more on this topic, see pages 60 and 61.

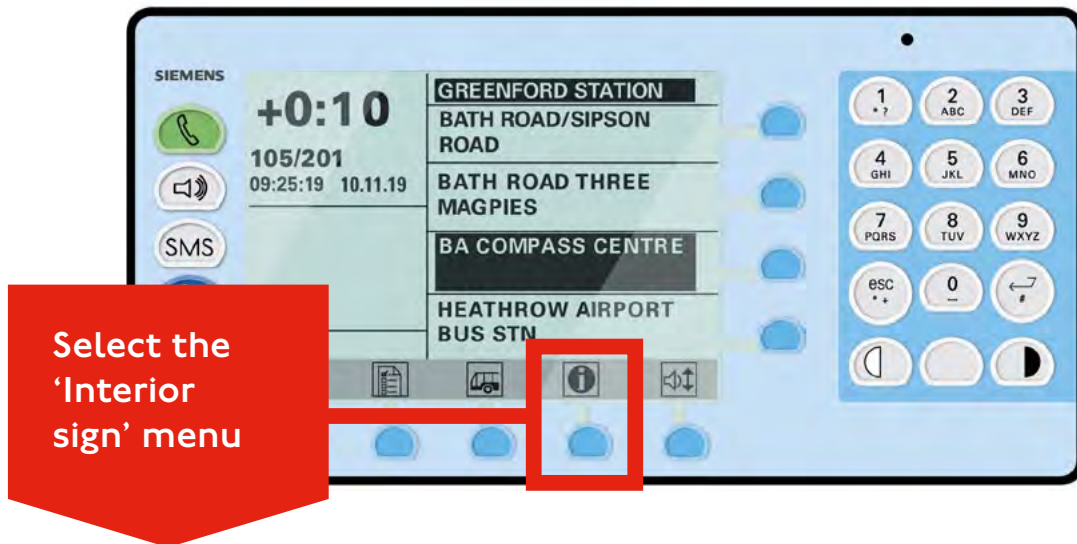

Scroll up or down until the announcement you want is shown

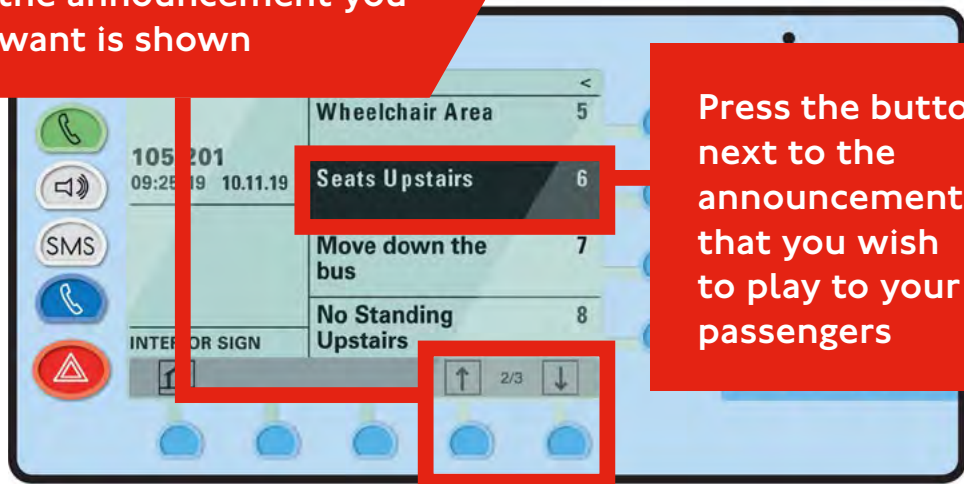

Press the button next to the announcement that you wish to play to your passengers

### Low bridge warning alarm

Whether you are logged on to the MDT or not, it will warn you about any low bridges in the area around your bus. This will be given as an audible warning alarm. If you hear the alarm, or see the information shown below on your MDT screen, make sure you check the height of any bridge you are approaching – especially if you have been asked to go on diversion. Remember your ABCDs (see page 8).

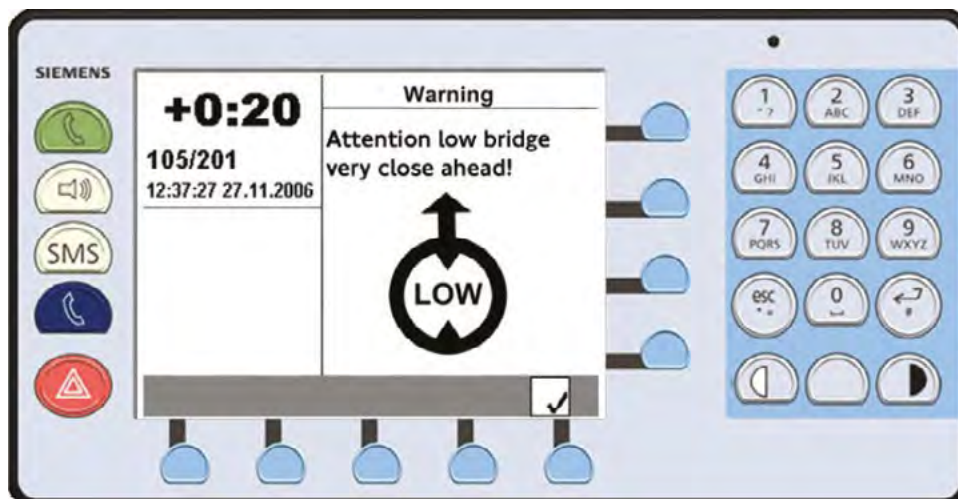



## Pre-recorded announcements

iBus can help you communicate with your customers through pre-recorded announcements that, among other things, let them know about stop closures or a change of driver. Also, you can ask customers to move down the bus or out of the wheelchair priority area and, if your bus is busy, you can let them know that seats are available on the upper deck.

The pre-recorded iBus announcements also help in situations where conflict might occur. For example, if you suspect antisocial behaviour or unwanted sexual attention on your bus, play the pre-recorded announcement '**Closed circuit television is in operation on this bus**'.

For information on how to use your MDT to play these pre-recorded announcements, see page 58.

**Note: Customers have told us that a PA announcement after a pre-recorded announcement can be very helpful to them (see pages 62 - 66).**

### The pre-recorded announcements on iBus\* are:

- This bus terminates here. Please take your belongings with you
- This bus is on diversion. Please listen for further announcements

\*as at March 2019



- The destination of this bus has changed. Please listen for further information
- The next bus stop is closed
- A customer needs the wheelchair priority area. Please make space
- Please move down inside the bus
- Seats are available on the upper deck
- No standing on the upper deck or stairs please
- Closed circuit television is in operation on this bus
- The driver will open the doors as soon as it is safe to do so
- For your child's safety please remain with your buggy
- The bus will wait a short time for a change of drivers to take place
- Customers are required to make space for a wheelchair user. The bus will wait while this happens
- The driver has been instructed to wait at this bus stop for a short time to help even out the service
- This bus is ready to depart

This list may change from time to time, and the reinstatement of 'The driver has been instructed to wait...' announcement has been made following requests from drivers. Please check your MDT and look out for notices in your garage.

## Using the PA system

It is important to keep customers informed, especially when things go wrong, as it helps them and makes things easier for you. While pre-recorded announcements are useful, many customers tell us the PA system is the best way to do this.

You can also use the PA system together with the pre-recorded announcements to help you move customers down the bus or out of the wheelchair priority area, also to give further details about a change of destination or a diversion to reassure customers.

When you press the PA button to speak, customers will





hear a 'bong' so they know you are about to make an announcement. While you are speaking, the iBus customer display will show **'Announcement in progress'** until you finish.

Remember, you have up to 40 seconds to make your announcement.

You will usually need to give your customers advance warning of disruption. On a diversion, for example, tell them at least twice what is happening. Make the first announcement a few stops before the beginning of the diversion, and the second at the stop closest to the start of the revised route.

### The benefits to you are:

- You can talk to all your customers at once
- You feel more in control of the situation
- Customers see you as a professional
- You will be asked fewer questions

### The benefits to your customers are:

- It gives them control of their journey and allows them to make alternative plans
- It makes them feel safer
- They can let other people know they may be delayed



**Here are some simple guidelines to help you:**

- 1 Before you speak, close the doors so people can hear you.
- 2 Think about what you need to tell your customers and the best place to tell them – write down a few important points if it helps and keep the message short and simple.
- 3 Make sure you face the microphone – looking at the yellow sticker around the black stub microphone attached to the small black box (often it is above your head but sometimes it could be in front of you or to one side). Press the PA button – see page 62.

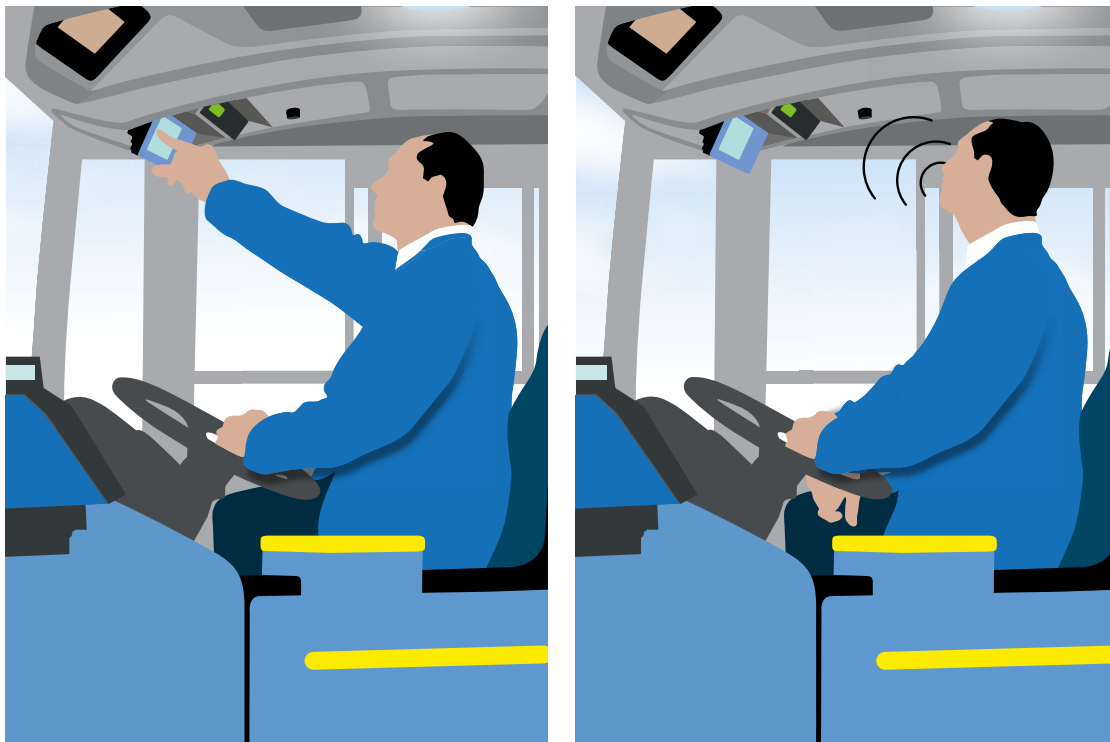





- 4 Think of your announcement as having three parts – an introduction, the main message and a few words at the end:
  - Introduce yourself and get customers' attention with something like:
    - 'This is your driver speaking'
    - 'Good morning/afternoon/evening'
    - 'May I have your attention please?'
  - For the main message, keep it short, speaking slowly and clearly:
    - Apologise or say sorry for the disruption, delay or inconvenience
    - Use simple words, not jargon such as RTC (road traffic collision)
    - Smile as you speak, as this will lift your tone
    - Suggest customer options
  - End the message with 'thank you' or 'thank you for your patience'
- 5 Suggestions for announcements:
  - 'This is your driver speaking. I have been asked to wait for two minutes as we are running early. You may leave the bus here if you wish. Sorry for the delay to your journey. We will be on our way soon. Thank you for your patience'



- 'Good morning. I am sorry to say the next bus stop for [name of station] is closed due to roadworks. You may leave the bus here if you wish. Our next stop will now be [name of next stop on line of route]. Thank you'
- 'May I have your attention please? This bus is about to go on diversion after [name of next stop]. We will not be calling at [one/two missing stops], so if you need these stops you should get off at [name of next stop]. We will go back to our usual route at [name of next stop on line of route]. Please ring the bell if you wish to get off while we are on diversion. Sorry for any inconvenience. Thank you for listening'

**6** Practise when no one is on the bus. You can also try a non-urgent message such as: 'Good morning/afternoon. This bus will terminate at the next stop. Please take your belongings with you. Have a good day.' This will give you the confidence to use the PA system when you need to.

Some drivers worry because English is not their first language, or they do not feel comfortable using the PA system. Remember that many customers also do not have English as their first language, but everyone will appreciate your efforts to give them information that makes their journey easier. Just think about what you need to say and follow the guidelines above.

### You said, we did...

This is a series of posters produced during 2018 about our stopping policy. It is aimed at customers and supports the information provided to bus staff.

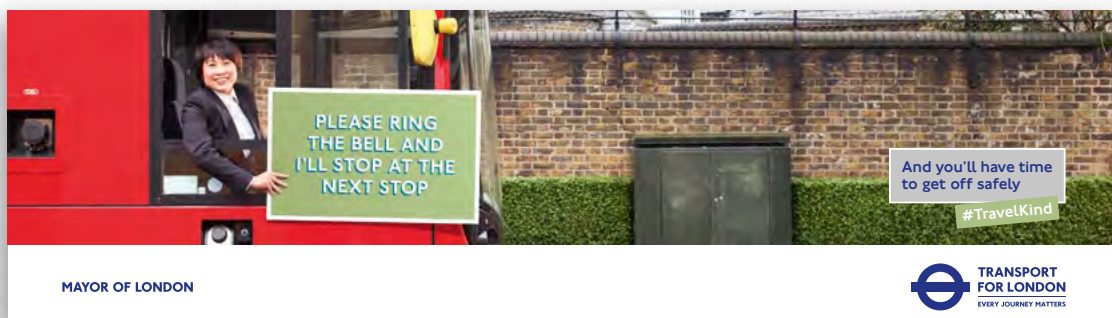

# London's safe bus drivers

- 71 Pedestrians, cyclists, motorcyclists and other road users
- 74 Vision Zero
- 77 London's Bus Safety Programme
- 79 Fatigue and how to combat it



High Street 461



## London's safe bus drivers

This section contains guidance on how you can keep yourself and your customers safe, while providing a professional service that we can be truly proud of. When we leave our homes each day we should feel safe and confident about the journey ahead.

Anybody who is killed or seriously injured on our transport network is someone's mum, dad, brother, sister, daughter, son, partner or friend – and no incident should ever be seen as inevitable or acceptable.

Our target is Vision Zero, which means eliminating fatalities and serious injuries from London's transport network by 2041. Major cities around the world are committing to Vision Zero, but London is at the forefront of this approach. To highlight this, the Mayor's Transport Strategy sets out a further pledge to ensure that, by 2030, no one is killed on, or by, a bus.

For more information, see pages 74 – 76.

## Pedestrians, cyclists, motorcyclists and other road users

There are increasing numbers of cyclists on London's roads and, at all times, you should make sure you are aware of them – take great care, for instance, around Cycle Highways and cycle users across the capital. You also need to look out for pedestrians and other vulnerable road users. Here are some important guidelines to follow:

- 1 Give all cyclists space as you overtake (about half the width of your bus, or 1.2 metres at least) and make sure the whole bus is clear of the cyclist before you pull back in. Do not cut in on cyclists as you approach bus stops or road junctions. It is often safer to hold back for a few seconds and wait for cyclists to go past a stop or through a road junction. Overall, this will not affect your schedule.

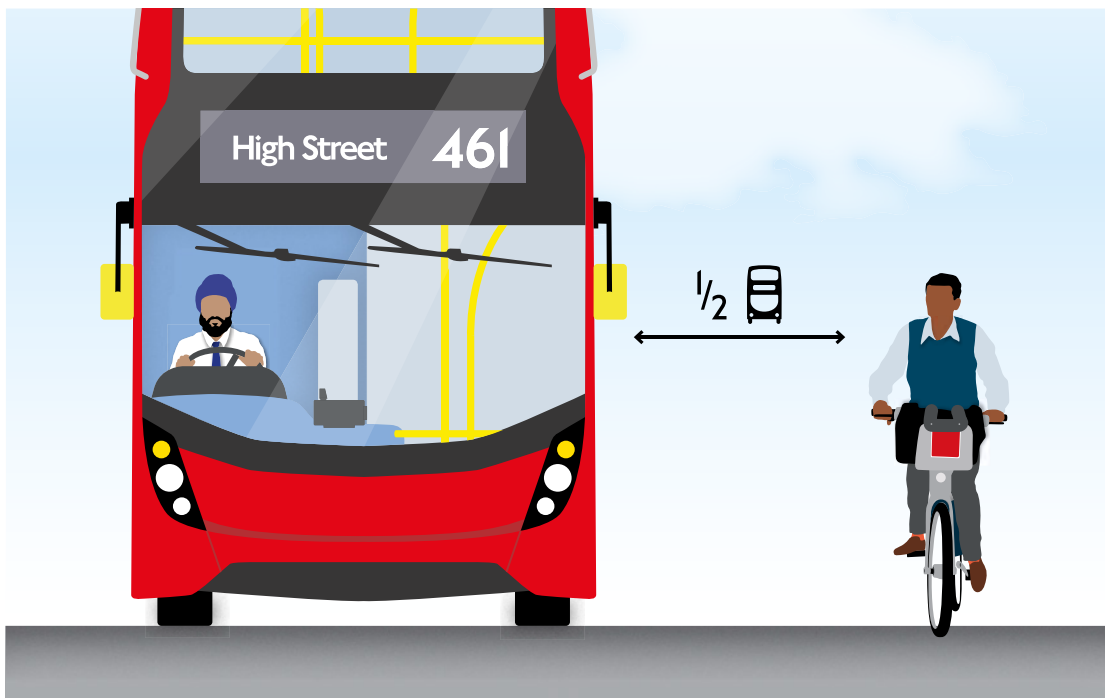

- 2 Do not stop in the advanced stop box as it must be left clear for cyclists. The police may issue a fixed penalty fine and you may receive three penalty points on your licence.



- 3 Watch out for pedestrians and keep your speed low. Be aware of bus customers alighting your bus or another bus and crossing the road in front of you.





- 4 Use dipped headlights, especially in contraflow bus lanes and central areas, such as Piccadilly or within a busy bus station like Victoria. Your company procedures may require you to use dipped headlights at all times.
- 5 If you are driving a hybrid or electric bus, it is important that you look out for children and older or disabled people – especially blind and partially sighted people – as your bus will be quieter than other models and they may not know you are there. As part of the Bus Safety Programme, from late 2019 new-build hybrid and electric vehicles will be fitted with an audible alert to make sure pedestrians and other road users are aware that these buses are nearby.
- 6 During school hours, look out for children and young people around schools or in built-up areas.
- 7 Watch out for wheelchair and mobility scooter users, especially where their mobility aids have been designed to be used on the road.
- 8 Be aware of motorcyclists, who can use certain bus lanes.
- 9 At road junctions, be aware of lorries and other large vehicles. Like buses, they need a wide area to turn.
- 10 Be prepared to stop if taxis are picking up or setting down customers in bus lanes. Other vehicles may also pick up or set down in bus lanes.



## Vision Zero

This is an international road safety initiative based on the belief that it is never acceptable for people to be killed or seriously injured on the road transport network.

The Mayor's Transport Strategy sets out the commitment that fatalities and serious injuries will be eliminated from London's roads by 2041. Alongside this, the industry has set an even more challenging target that, by 2030, no one should be killed on, or by, a London bus. To achieve this, Vision Zero is underpinned by the principle that human fallibility is inevitable and people will make mistakes, but it is a shared responsibility to keep them as safe as possible.

Vision Zero's 'safe system' principles are:

- Safe speeds
- Safe behaviour
- Safe vehicles
- Safe streets

These will be explored in detail, and the shared responsibility explained, in the safer bus driving programme called 'Destination Zero'.



All drivers will participate in this innovative programme. It will be delivered at your bus operator training centre, but the content will be the same for all 25,000 London bus drivers. The programme will begin in April 2019 and the aim is to complete the training by the end of 2020.

Destination Zero will:

- Introduce the Mayor's Vision Zero programme
- Provide drivers with an alternative perspective on safe driving
- Identify specific actions that drivers can take to contribute to Vision Zero

The programme will draw on current thinking around safer driving and incorporate new and creative learning methods. It is designed to support your existing safe driving practices.

All driving instructors will also attend a one-day workshop to make sure the safer driving messages are shared with new drivers and those who attend bus operator training schools.



# London's Bus Safety Programme

There are fewer than three injuries for every million journeys on London's buses, and we recognise this is down to the hard work you put in every day. As part of Vision Zero, our Bus Safety Programme is also driving major safety improvements across our network.

We fund a range of initiatives to reduce collisions and improve existing safety processes and data collection. These are outlined below.

## **Safe speeds**

Speed is one of the most important factors in determining whether a collision occurs and how severe it is. Intelligent Speed Assistance (ISA) technology, which prevents vehicles from exceeding the speed limit, has already been fitted on some vehicles in our fleet and will continue to be rolled out on new buses from 2019.

## **Safe streets**

Streets must be designed, built and maintained to support a mix of safe walking, cycling and public transport use. TfL works with bus operators, the police and the boroughs to make sure our streets are safe.

## **Safe vehicles**

We have developed a world-leading Bus Safety Standard that is now incorporated into bus operator route contracts.



It includes:

- Mandating the fitting of ISA technology to all buses
- Trialling technologies such as Autonomous Emergency Braking, which detects other road users in a vehicle's path and brakes automatically
- Improving direct and indirect vision for drivers
- Redesigning the front of buses to help reduce the impact of a collision
- Using audible warnings to alert pedestrians and other road users to the presence of buses
- New bus interior designs to reduce customer injuries

Not all technologies trialled for the Bus Safety Standard are available immediately. Some will become available as we work towards achieving Vision Zero.

### **Safe behaviours**

All road users are responsible for safe driving, especially those in charge of large vehicles with the most potential to cause danger to others.

### **Sarah Hope Line**

For customers affected by serious or fatal incidents involving TfL services, our specially trained Sarah Hope Line support staff can provide guidance and practical advice. To find out more, go to [tfl.gov.uk/campaign/incident-support-service](https://tfl.gov.uk/campaign/incident-support-service)



# Fatigue and how to combat it

## What is fatigue?

People who experience fatigue feel very tired, weary or sleepy. However, you can combat it with improvements to your sleep, diet and exercise, as detailed below.

### Sleep

- Plan your sleep periods so you get enough undisturbed rest. Lack of sleep builds up over days and weeks and leads to fatigue
- Where possible, create the right environment for sleep – a dark room, limited noise and no interruptions
- Develop a wind-down routine before bed that involves relaxation, listening to music or reading, a warm bath or light stretching exercises

Try to eliminate distractions before going to bed, such as TV, computers or electronic games in the bedroom, bright lights or an external light shining in.



### **Diet**

- Hydrate to concentrate – try drinking more water to help you concentrate and stay alert
- Eat often, eat healthier and eat small portions to beat tiredness
- Breakfast gives you the energy you need to face the day
- Fruit and vegetables are good sources of vitamins, minerals and fibre – essential nutrients that your body needs to work properly
- Slow-burning starches or carbohydrates, for instance, potatoes, breads, cereals and pasta, are good for sustained energy
- Sugar steals your stamina – it gives you an instant rush of energy that wears off quickly
- Eating healthy snacks between meals is a great way to keep energy levels up

### **Exercise**

- Get moving. Regular exercise will make you feel less tired in the long run, so you'll have more energy
- Start with a small amount of exercise. Even one 15-minute walk can give you an energy boost and the benefits increase with more frequent physical activity





### You said, we did...



This is one of a series of posters produced during 2018 that highlight customer safety messages and support information provided to bus staff.

# London's accessible bus network

- 87 Customers with invisible disabilities
- 89 Travel support card
- 90 Assistance dogs
- 92 Blind and partially sighted customers
- 93 Deaf customers
- 94 Please offer me a seat badge and card
- 95 Who can use ramps on buses?
- 96 Wheelchairs and mobility scooters allowed on the bus
- 98 Boarding procedure for wheelchair and mobility scooter users
- 104 Mobility walkers and shopping trolleys
- 106 Mobility Aid card





## London's accessible bus network

Our fleet is made up of low-floor buses and each one can be lowered further so the height of the floor is in line with the kerb and every bus has an accessibility ramp. In addition, 95 per cent of London's bus stops are wheelchair accessible (at March 2019).

While it is helpful to have accessible buses and wheelchair accessible stops, it is London's bus drivers who can make a huge difference to the travelling experience of older and disabled people. Accessibility is not just about making journeys easier for wheelchair users, it's about ensuring the network is a realistic travel option for every one of our customers.

A good bus trip will have a positive effect on an individual and could lead to a commendation for a memorable experience. Where the driver is less than helpful, it is likely to have a negative effect and may result in a complaint. In some situations, it could be the difference between someone having the confidence to use London's bus network and them staying at home for fear of another bad journey. Or worse, a bad bus trip could result in injury or pain to the individual.

Be aware that disabled customers and people with impairments or conditions may feel vulnerable or concerned about hostility from other people when using London's bus network. Show that you care and remember your ABCDs. If you are aware of any threatening behaviour or a customer brings a situation to your attention, call **Code Red** when you need emergency help. For more details, see page 8.



On the following pages there are important guidelines that will benefit all your customers, especially those who are older or disabled.

- 1** At bus stops, you must pull in close to the kerb wherever possible. Before you open the doors, assess whether lowering the bus will help your customers, especially if they have to step up on to the platform.
- 2** You must also lower the bus, if:
  - Someone asks. Advise the customer you may have to shut the doors before lowering the bus
  - You can see somebody needs it, for example, they may be using a walking stick or crutch(es) and it could help a wheelchair or mobility aid user board the bus by reducing the steepness of the accessibility ramp
- 3** Older and disabled customers may need more time to board, so lowering the bus will help. For their safety, please be patient and make sure they are seated, or at least holding on, before you move off.
- 4** Remember, not all impairments or conditions can be seen, so never make assumptions and do not question anyone's entitlement to a disabled person's Freedom Pass. They may, for example, be deaf, have a learning disability or live with dementia.



- 5 Be ready to offer help. This could be something as simple as facing customers so they can lip read, writing things down or giving some customers a little extra time.
- 6 If a customer says they need a seat, is wearing a Please offer me a seat badge (see page 94 for details) or a Baby on board badge, be prepared to ask other customers to give up their seat if they are able to do so.
- 7 If you are driving a hybrid or electric bus, look out for older and disabled people – especially those who are blind or partially sighted – as your bus will be quieter than other vehicles so they may not be aware that you are there.
- 8 The instructions listed in the section 'Boarding procedure for wheelchair and mobility scooter users' (see pages 98 – 103) also apply to Mobility Aid card users.
- 9 If a stop is closed or you are diverted from your usual route, tell your customers what is occurring. This will reassure everyone, but especially older and disabled people who could become distressed or frightened if something happens that is not explained to them.
- 10 If you are aware the audio and visual announcements are not working correctly, or a customer informs you that this is the case, report it immediately to your controller and record it on your log card. Using your PA system, make your own announcements at major stops along the route as customers will appreciate your help.

## Customers with invisible disabilities

Not all impairments or conditions can be seen. For example, customers may be autistic, living with dementia or have a learning disability (see page 88 for an example of a communication tool adopted by a charity, the National Autistic Society's Autism alert wallet used by some autistic people).

- If someone appears confused or unsure at the bus stop, call out your route number and destination as it could reassure them that they have the right bus
- The customer may show you a travel support card with a specific request or message. Please provide the help they need wherever possible (see page 89)
- If a customer appears distressed or confused as they board the bus, ask if you can help. A bit of reassurance and empathy will go a long way
  - An autistic person could be disorientated if you are driving a bus that is different from the type that usually appears on that route
  - A person living with dementia could become confused and might panic if they cannot find their pass. Allow them to take a seat and ask them to come back when they have found it. This can often help as, once they relax, the situation can become clearer

- An autistic person or someone living with dementia could become distressed or disorientated by an unexpected change of route or a diversion. A PA announcement from you to explain what is happening would help to reassure all customers (see pages 62 - 66)
- During a trip, or at the end of a journey, if you feel something may be wrong, ask the customer if everything is okay. If you think they could be vulnerable and need some help, use your ABCDs – assess the situation, ensure the person is safe, call **Code Red** for assistance and do as advised

Many autistic people use the National Autistic Society's Autism alert card or wallet to make other people aware of their condition, as shown below:





## Travel support card

We provide a travel support card that customers can show you if they need help or want to make you aware of something.

- Inside the card there is a space for people to write down a short message
- The card can be used by any older or disabled customer, but is mainly aimed at those who have difficulty communicating or who might lack the confidence to ask staff for help
- The card, plus an example of how it might be used, is shown below:

<p><b>How you can help me:</b></p>	<p><b>My name is:</b></p>
<p><i>Please tell me if I'm on the right bus for Victoria Station?</i></p>	<p><i>Simon Brown</i></p>
	<p><b>My emergency contact number is:</b></p>
	<p><i>07123 456789</i></p>
<p><b>Thank you.</b></p>	<p><small>This is not a ticket and does not entitle the holder to any discount.</small></p>

We are working with organisations that support people with learning disabilities to promote the use of the travel support card for those who could become vulnerable. Please look out for customers with this card and offer help where you can.

A number of other charities and organisations have adopted similar communication tools, including the National Autistic Society's Autism alert card and wallet (see previous page).



## Assistance dogs

These dogs are specially trained to help disabled people travel more independently. As well as guide dogs for blind and partially sighted people, there are assistance dogs that support, for example, autistic people, those with epilepsy or other disabilities. All assistance dogs are welcome on London's buses. Look out for their distinctive jackets or harnesses and be patient and ready to offer help during boarding.

If there is space, there is no limit on the number of assistance dogs you can allow on board. They may travel on any deck of the bus.



Guide Dogs

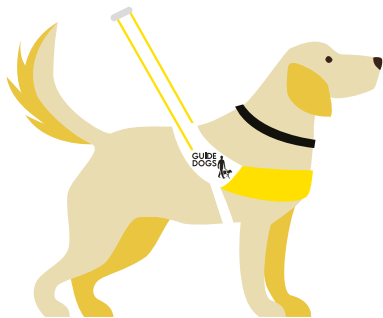

Canine Partners



Support Dogs



Dogs for Good



Medical Detection Dogs



Hearing Dogs for Deaf People



Dog AID (Assistance in disability)



## Blind and partially sighted customers

Look out for customers who are blind or partially sighted when you approach bus stops, especially where you are the second or third bus to arrive at the stop. They may also need you to pull in close to the kerb and lower the bus.

- If a blind or partially sighted customer is waiting at a bus stop, let them know the route number and where your bus is going before they board. Although iBus announces the destination, it will only do so once the customer is on board, so it will be helpful for them to hear you say it first
- Ask where they are going so you can tell them when you reach their stop. Some blind people use a white cane, but not all do. For example, young people may feel it draws attention to them
- Let blind and partially sighted people know where a seat is available and how far away it is from where they are standing. For example, 'there's a seat on your right or left about three steps in front of you', is better than 'over there'. Make sure you give them enough time to get to a seat
- Blind and deaf customers use a white cane with red stripes
- Blind and partially sighted people with guide dogs do not need to show a concessionary ticket or validate a Freedom Pass. This is because it can be difficult to touch their pass on the reader while holding the dog's harness

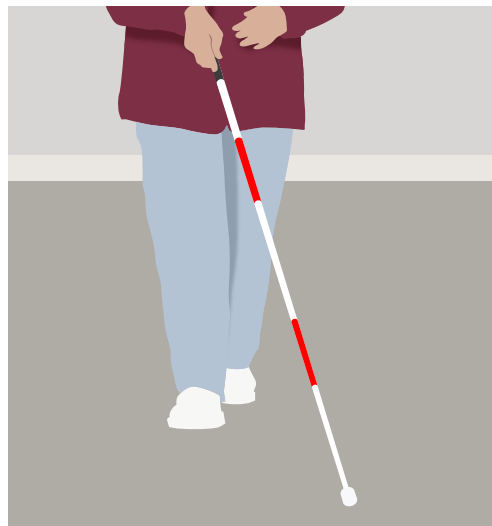

## Deaf customers

If a customer says they are deaf or hard of hearing, face them and speak a little slower as they may be able to lip read.

- Do not shout as this will distort any sound and the shape of your mouth
- Be prepared to write down what you need to say if you think it would help
- Most modern buses are fitted with a T-loop, which amplifies the sound for customers with hearing aids. If your bus is fitted with a T-loop there will be a sign on the cab door and you should advise customers so they can select the 'T' position on their hearing aid. The T-loop operates in the driver's cab and the area around the wheelchair priority space



## Please offer me a seat badge and card

Many of our customers, particularly disabled people and those with invisible impairments, conditions or illnesses, find it difficult to get a seat. Our free Please offer me a seat badge and card make it easier for them to let other customers know that they need to sit down.

The badge and card can be ordered from TfL Customer Services on **0343 222 1234** or via our website at **[tfl.gov.uk](https://tfl.gov.uk)**

They can be used by any older or disabled customer but are mainly aimed at people with invisible impairments, conditions and illnesses.

The badge and card are shown below:



## Who can use ramps on buses?

The answer is anyone who needs them or asks. The maximum weight acceptable for the ramps fitted to London's buses is 300kg.

Ramps were originally introduced to allow wheelchair and mobility scooter users to access low-floor buses. However, we now know there are other customers who benefit from using this facility to get on and off the bus, such as those using a walking stick or mobility walker and holders of the Mobility Aid card (see page 106). The ramp is now properly referred to as an accessibility ramp, so extend it if a customer asks you.

This means it is important to make sure your ramp is working before you start your duty. If it fails while you are in service, contact your garage immediately.

**Note: Anyone using the accessibility ramp must always face forward for their own safety - this means facing towards the bus when they get on and towards the kerb when they get off.**





## Wheelchairs and mobility scooters allowed on the bus

Wheelchair and mobility scooter users travel free on London's buses. They do not need to have, or show, a concessionary ticket or Freedom Pass.

Most manual and electric wheelchairs will fit in the priority area. These, plus the user, will generally weigh less than the usual maximum amount acceptable for the ramps fitted to London's buses (which should be at least 300kg). Motorised mobility scooters are different and only the more compact designs will fit in the wheelchair priority area. Use your discretion and allow this where possible. Some types of mobility scooter are too large (for example, those with front and rear lights and hazard warning lights).

To board using the ramp, and to be positioned safely on a London bus, the mobility aid will need to fit within the following dimensions:

**Maximum width: 600mm (1.97ft)**

**Maximum length: 1,000mm (3.3ft)**

**Maximum turning radius: 1,200mm (3.9ft)**

Follow these guidelines to help you decide whether the mobility aid can fit.

Some customers may have a Mobility Aid card if they use a large wheelchair or mobility scooter. See page 106 for further details.

If you refuse a mobility scooter (or other mobility aid) because you think it will not fit, tell the user about the





Mobility Aid card. They can find out more about the card and how the travel mentor team could assist on our website at [tfl.gov.uk](https://www.tfl.gov.uk)

The Mobility Aid card is very helpful but users of wheelchairs and mobility scooters that fit may not have one. For customers without a Mobility Aid card, follow these guidelines to help you decide whether the mobility aid can fit:



Nearly all manual wheelchairs will fit



Nearly all electric wheelchairs will fit



Compact mobility scooters may fit



Large mobility scooters cannot be carried

## Boarding procedure for wheelchair and mobility scooter users

Wheelchair and mobility scooter users must be given access to the wheelchair priority area even if it is occupied by buggies and other customers. They can only travel safely in the priority area, so you must ask customers to move by using the pre-recorded announcements or making your own PA announcement.

It is important you stay professional and calm as this will help wheelchair and mobility scooter users feel valued and more confident about travelling on London's buses.

### Getting the wheelchair or mobility scooter user ON the bus

- 1 Acknowledge the wheelchair or mobility scooter user, so they know you have seen them. Be prepared to politely gesture to the wheelchair or mobility scooter user if they want to board your bus.

Pull in close to the kerb and make sure your bus is not parked where obstacles on the pavement, for instance litter bins or railings, could obstruct the ramp.



If you find that obstacles on the pavement or reduced space do not allow you to fully lower the ramp, be prepared to move to another part of the pavement.



- 3 Keep the front doors closed on two-door buses, so the wheelchair or mobility scooter user is given priority access (see illustration on page 100).
- 4 Check the wheelchair priority area is free. If it is not, use your PA system or play the first pre-recorded announcement, '**A customer needs the wheelchair priority area. Please make space**'.
- 5 Allow other customers off. Close the middle doors and extend the ramp. Ensure the ramp is fully lowered to the ground and audio/visual alerts indicate the ramp is ready to use before opening the doors. Re-open the middle doors and let the wheelchair or mobility scooter user on. Make sure they have enough time to position themselves safely in the priority area.
- 6 Open the front doors to let other customers on.

**Note: The wheelchair priority area is designed to safely carry one wheelchair or mobility scooter user with their back against the padded backrest, positioned against the direction of travel. If there is enough room, other customers can share the space.**



## Getting the wheelchair or mobility scooter user OFF the bus

- 1 Listen and look for the distinctive bell and dashboard light.
- 2 Pull in close to the kerb and make sure your bus is not parked where obstacles on the pavement, for instance litter bins or railings, could obstruct the ramp.
- 3 Let other customers off then close the middle doors and extend the ramp.
- 4 Re-open the middle doors and let the wheelchair or mobility scooter user off.
- 5 Keep the front doors closed on two-door buses to prevent conflicting movement.



- 6 When the wheelchair or mobility scooter user is safely off the bus, open the front doors to allow customers on.

**Note: On New Routemaster buses, it is currently not possible to open the doors separately, so drivers should make a PA announcement to inform other customers that a wheelchair or mobility scooter user wishes to get on or off the bus. We will let you know when this changes and ask that you look out for driver notices.**

### What if people don't make room?

If a wheelchair or mobility scooter user wishes to board your bus, you are required by law to ask non-disabled customers, more than once, to move, fold their buggy or share the space. You must speak to customers in the wheelchair space if they are unwilling to move.

- A wheelchair or mobility scooter user and one unfolded buggy can often share the priority area
- Do not put yourself at risk
- Explain to the wheelchair or mobility scooter user and buggy owner that they may be able to share the space, as this could resolve the situation. You should allow this provided the wheelchair or mobility scooter user is in the correct position (against the padded back rest), is happy to share the space and the buggy does not block the gangway



- Reassure buggy owners that you will not move off until they are safely repositioned
- If a buggy owner or other customer already on the bus is willing to get off to provide more space, thank them and remind them (if they used pay as you go) that the Hopper fare allows them to make unlimited journeys for one single fare when they change buses within one hour of touching in on the first bus



- If customers are still unwilling to move from the priority area:
  - Make your own PA announcement to emphasise that people must make space for the wheelchair or mobility scooter user or play the second pre-recorded announcement, **'Customers are required to make space for a wheelchair user. The bus will wait while this happens'**
- If other customers create space, thank them as this will make them feel valued

If, despite all your efforts, customers remain unwilling to move from the priority area, do not insist they leave the bus:

- Tell the wheelchair or mobility scooter user they will need to catch the next bus. Apologise and explain why you were unable to make space for them. Let them know that you will contact your garage
- Contact your garage to make sure the next driver knows the customer is waiting
- Do not close the doors and move off until you have done this



## Mobility walkers and shopping trolleys

Some customers who use wheeled walkers or shopping trolleys to help with their mobility may ask if they can use the middle doors and ramp to enter and leave the bus. This is because it is the safest and easiest way for them to do so.

If you are asked, extend the ramp or lower the bus if this helps. If they do not ask, check whether they would like the bus lowered to make boarding easier. Do the same when they want to get off.







Customers with mobility walkers and shopping trolleys should be allowed to position their mobility aids in the wheelchair priority area. Make sure they have time to position themselves safely, either seated on a mobility walker or seated nearby, before you move off.

- If a wheelchair or mobility scooter user is already in the wheelchair priority area and a customer with a mobility walker wishes to board the bus, the wheelchair or mobility scooter user should remain in the space
- If the boarding customer is unable to fold their mobility walker and needs to sit on it, any non-disabled people sharing the space should be asked to fold their buggies or move so the mobility walker user can travel in the priority area
- The user of a shopping trolley (as a mobility aid) or a mobility walker that can fold should be allowed to place it in the priority area while the customer sits on a seat nearby
- If, despite your best efforts, customers remain unwilling to move from the priority area, do not force them to leave the bus. Explain the position politely to the mobility walker user. Let them know that you will contact your garage
- Contact your garage to make sure the next driver knows the customer is waiting
- Do not close the doors and move off until you have done this

## Mobility Aid card

We have introduced a revised Mobility Aid card, approved by both TfL and bus operators, for customers whose mobility aids (mobility scooters, shopping trolleys (used as mobility aids) and adapted buggies for disabled children) are able to have access to the wheelchair priority area. It includes photos of the holder and their aid. A larger mobility aid label should be displayed on the aid itself. Please look out for these as the instructions listed in the section 'Boarding procedure for wheelchair and mobility scooter users' (see pages 98 - 103) also apply to Mobility Aid card users.

The Mobility Aid card is very helpful, but some customers with scooters that fit may not have one. For anyone without the card, use your best judgement (see page 96).



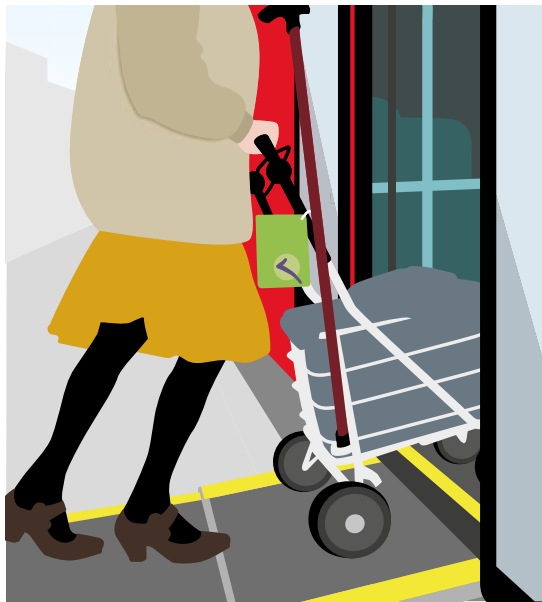

Customers can find out more about the Mobility Aid card and how the travel mentor team could assist on our website at [tfl.gov.uk](https://www.tfl.gov.uk)



## What do I do if the ramp fails...

### ...while I am in service?

If the ramp fails after you have left the garage, your bus can be kept in service but you must contact your garage immediately so the problem can be fixed or your bus substituted at the earliest opportunity.

### ...when a wheelchair or other mobility aid user is on board?

Reposition your bus and try again as the ramp may be blocked by the pavement or something on it. If this does not work, contact your garage for advice. Some wheelchair or mobility aid users may decide to try to get off without the ramp, and it may help if you lower the bus. Talk to them and work out the best option, but do not put yourself or the customer in danger. Other people may be willing to help but always discuss this with the wheelchair or mobility aid user first.

### ...and I have to evacuate the bus with a wheelchair or mobility aid user on board?

Evacuate all other customers first then call **Code Red**, explaining that you have a wheelchair or mobility aid user on your bus. If the situation becomes dangerous and you need to get the customer off before help arrives, you must ask what support they need before you attempt to move them. If necessary, get assistance from other customers or people nearby.

**You said, we did...**

This is the poster produced during 2018 asking buggy owners to make space for wheelchair users. It supports the information provided to bus staff.



# Support for London's bus drivers

- 113 Network Management Control Centre
- 122 Pre-loaded SMS text messages on iBus
- 125 Radio use during major incidents
- 126 Should the worst happen
- 130 Security and terrorism awareness





## Support for London's bus drivers

We understand things don't always run smoothly, but we will do everything we can to make sure you are safe at work.

If something does go wrong, Network Management Control Centre can get you help fast. This section contains details of the support services available, as well as information to keep you and your customers safe and secure.

Use your ABCDs:

**A – Assess situation**

**B – Be safe**

**C – Call for help**

**D – Do as advised**

For more details see page 8.



# Network Management Control Centre

The Network Management Control Centre (NMCC) is TfL's emergency command and control centre (the name CentreComm no longer exists). It operates 24-hours-a-day, seven-days-a-week to monitor and support London's bus and road network.

NMCC helps you by:

- Managing your emergency calls and making sure the right help gets to you
- Working with the emergency services, other TfL employees, your operating company and you to make sure the service is safe and secure at all times
- Monitoring more than 1,400 traffic cameras across London to help bus drivers and identify potential issues. NMCC also has access to other cameras
- Diverting buses when there are problems ahead
- Receiving and dealing with road traffic collisions (RTCs) and crime reports
- Making sure buses are given priority when things go wrong
- Working closely with the police to share information and prevent future problems by identifying trouble hotspots
- Manage and monitor more than 6,500 sets of traffic signals to keep London moving



### Call **Code Red** when you need emergency help, for example, if:



- You or your customers are threatened or are in danger from a violent or aggressive customer or another road user
- A customer is hurt or has been taken ill on your bus
- A customer tells you they have been a victim of a crime such as theft, assault, a hate crime\* or unwanted sexual attention\*\*
- You notice someone committing a crime or acting in a way that causes you concern about the safety of other people
- You feel a customer could be in danger or something about them does not look right. For example, a young or vulnerable person is travelling while dressed in pyjamas, they look visibly distressed or a very young person is travelling on their own late at night or early in the morning
- A Revenue Protection Inspector (RPI), another TfL official or bus operator official asks you to call **Code Red** on their behalf

\* A hate crime is hostility towards someone because of their disability, gender, identity, race, religion or sexual orientation

\*\* Please note, if the suspect is still on the bus, use the code word 'Guardian' when you contact NMCC. If the suspect has gone, you should still contact NMCC and advise the customer to visit a police station or contact the police on 101 to officially report any crime. Victims of unwanted sexual attention can also report to the police by texting 61016



- There is a disturbance on or off your bus – a fight, pickpockets, ticket fraud or other antisocial behaviour
- There is an argument about paying a fare, for example, someone wants to use cash, has become aggressive and refuses to leave the bus (but would not be vulnerable)
- Your bus is badly damaged, has been involved in an RTC or has broken down and is causing an obstruction
- You see an incident that needs the emergency services, even if it doesn't involve your bus
- Someone is vandalising or damaging your bus
- The road ahead is blocked, or you cannot continue your journey safely
- You have been told to go on diversion and are not sure where to go

### Rough sleepers

We know that rough sleepers sometimes seek refuge on your bus as a place of safety and warmth. We are working with the support services to try to help these people.

Report non-threatening rough sleepers on your bus using the pre-loaded SMS text message option on iBus (see page I22). This information is collated and sent to outreach services to help direct their work towards the times and routes where people are sleeping rough. If you have a rough sleeper who is aggressive, needs urgent medical attention or you believe is under 18, call **Code Red** immediately.



Please see page 130 for guidance on dealing with suspicious packages, behaviour, and corrosive substance attacks.

Call **Code Blue** when you need to report an incident that does not require immediate help, for example:



- A minor RTC where no one is hurt. You should exchange details with the other party and continue your journey
- Your bus has broken down, but other traffic can get past
- Traffic light failure
- A bus stop or shelter has been damaged
- Something has happened on your bus, like graffiti or etching, especially if it is offensive (for instance, homophobic or racist comments). However, the individuals involved are no longer on board
- Someone has parked in the bus stop or bus lane, or a similar problem is making it difficult to continue your journey

If in doubt always call **Code Red**.



## Getting help fast

If you observe these guidelines, NMCC is the fastest way to get help in an emergency:

- Press the **Code Red** button for at least two seconds to get connected
- Stop the bus, as you will need to press the footswitch to speak to NMCC
- Tell NMCC what has happened
- NMCC will know where you are but be ready to confirm your exact location using streets/roads and junctions or local landmarks. This will help them or the emergency services to find you
- You may be asked a few questions by NMCC. This is because the emergency services need this information
- Use short, clear sentences. Speak calmly and clearly
- If you are cleared to go or the problem goes away, call **Code Red** again to cancel any call for emergency services – this will free them up to help other bus drivers

It is important that you tell NMCC exactly what is happening when you call **Code Red**, as this will make sure you get the best response. For example, if a customer has a knife or is threatening you, say so. Stay where you are and remain in the cab so you can answer any further calls from NMCC if they need to talk to you again. Remember to call **Code Red** again if the situation changes or the emergency services are no longer needed.



### Your call to NMCC

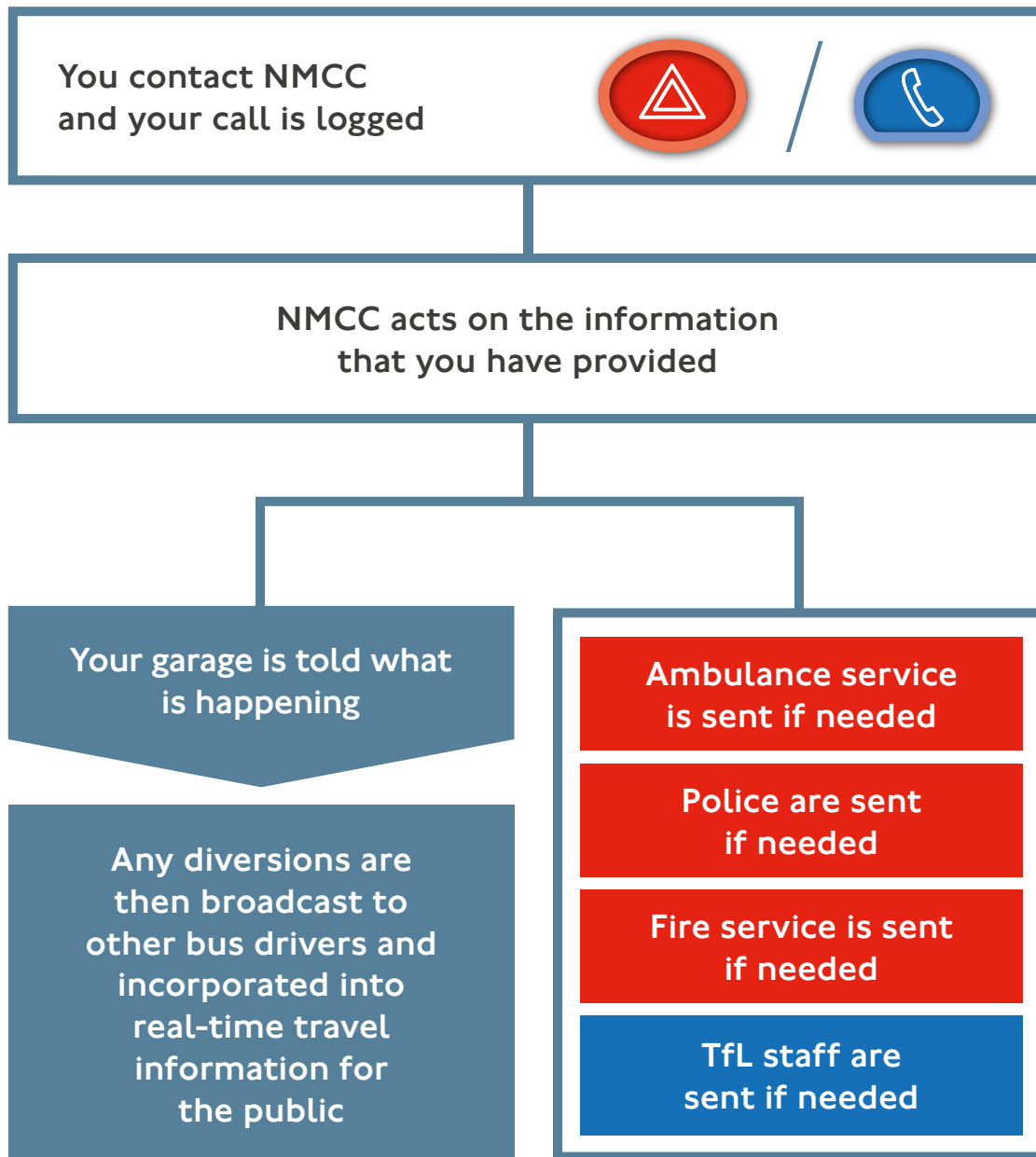



## Getting the help you need

The information you provide to NMCC is used to target problem areas.

Even if the police do not attend an incident on your bus, every **Code Red** call is entered into a database. This information is used to identify the best way to support you.

### Police and enforcement teams decide where to send:

- Police teams
- Traffic Enforcement teams

### Bus Operations decide which:

- Stops and stands need attention
- Roadside trees need cutting back
- Other changes are required across the network

### Bus Enforcement decide where to send:

- Individual RPIs
- Larger teams of RPIs with police support

### The Schools Liaison Team decide which schools to visit to:

- Talk to children about safe travel and respect for drivers
- Meet head teachers to talk about ongoing issues



## Should I call 999?

No, unless you are unable to use a bus radio. NMCC will know where you are and has a direct link to the emergency services operators, so they will know it is a call relating to London's bus network. Anyone calling 999 must identify themselves before giving details of the emergency, meaning it will take longer to get help. Calling **Code Red** will get you the right sort of help more quickly. We may also send TfL staff to attend or let other bus drivers and garages know about an incident.

## Police on the road

Sometimes the police might approach you while you are on the road. Please comply with their requests, but always check diversion routes with NMCC as the police may not be aware of any height, weight, length or width restrictions that will affect your bus while on a diversion route.

## Low-hanging branches or other obstacles

Let NMCC know if you see any low-hanging tree branches or obstacles on your route, and call **Code Red** if there is immediate danger or damage. In less urgent situations, complete an occurrence report at your garage. At TfL, we work with the London boroughs and other tree owners to make sure bus routes are safe.





## Going on diversion

Official diversions provided by TfL staff or NMCC must be followed and are checked regularly to make sure they are safe for buses. If you go on an unofficial diversion, stop your bus, call **Code Red** and let your customers know by using your PA system. For more details about diversions, see page 32.

## Identification codes

These codes are used by the police and NMCC to help identify individuals. They may help when you report an incident.

- IC 1:** White European
- IC 2:** Mediterranean European
- IC 3:** Afro-Caribbean/African
- IC 4:** (South) Asian – Indian, Pakistani, Sri Lankan, etc
- IC 5:** (East) Asian – Chinese, Japanese, Korean, etc
- IC 6:** Arabic

## Pre-loaded SMS text messages on iBus

Use the text message facility on the MDT whenever possible to keep radio contact (especially use of Code Blue) to a minimum. This will allow NMCC to respond faster to **Code Red** and other urgent calls.

The available SMS text messages\* are:

- 1 Please call me
- 2 Yes
- 3 No
- 4 Delay for toilet break
- 5 Fare evasion
- 6 Parking
- 7 Criminal damage
- 8 Rough sleepers
- 9 Departing now
- 10 Arrived at point
- 11 Clear to continue
- 12 Repeat your last message please

\*as at March 2019



- 13 Unable to transmit radio messages
- 14 Unable to receive radio messages
- 15 Lost property found
- 16 Awaiting assistance – revenue problem
- 17 Mechanical problem, can continue
- 18 Mechanical problem, unable to continue
- 19 Road closed ahead
- 20 Adverse weather at this location
- 21 ETM defective
- 22 RTD defective
- 23 Announcement error – On Bus Next Stop Sign (OBNSS) switched off
- 24 Bus in RTC – exchanged details/fit to continue
- 25 Bus in RTC – injury/major bus damage
- 26 Heavy traffic ahead
- 27 Heavy loadings



## The phonetic alphabet

This is used by NMCC, the police and other emergency services to make sure details are recorded accurately. For example, it allows you to clearly spell out a street name over the radio. Refer to the table below when you make a call to NMCC.

<b>A</b> lpha	<b>J</b> uliet	<b>S</b> ierra
<b>B</b> ravo	<b>K</b> ilo	<b>T</b> ango
<b>C</b> harlie	<b>L</b> ima	<b>U</b> niform
<b>D</b> elta	<b>M</b> ike	<b>V</b> ictor
<b>E</b> cho	<b>N</b> ovember	<b>W</b> hiskey
<b>F</b> oxtrot	<b>O</b> scar	<b>X</b> -ray
<b>G</b> olf	<b>P</b> apa	<b>Y</b> ankee
<b>H</b> otel	<b>Q</b> uebec	<b>Z</b> ulu
<b>I</b> ndia	<b>R</b> omeo	

## Radio use during major incidents

In bad weather, or during a terrorist attack or other major incident, radio use must be limited to essential calls only. This will ensure genuine emergency situations are dealt with quickly and effectively. The instruction to limit radio use will be announced by NMCC over the radio. Essential calls will still be broadcast from NMCC and service controllers to buses.

### Do:

- Make emergency calls to NMCC using **Code Red**
- Restrict your radio use as much as possible and keep your messages short
- Look out for, and use, the pre-loaded SMS text message facility on the MDT (see pages 122 – 123)
- Listen carefully to all broadcast calls from NMCC and your service controllers

### Do not:

- Make non-emergency calls, use **Code Blue** or report weather or traffic conditions unless asked to do so

When the major incident is over, NMCC will broadcast a message to all drivers.



## Should the worst happen

Most of your trips will be trouble-free but, on occasion, things do happen. To get the best help in the best way, remember your ABCDs:

### A – Assess the situation

You will need to let others, such as the NMCC, know what is going on. This means you will need to assess the situation. Ask yourself:

- What has happened?
- What is happening now?
- What seems out of the ordinary?
- Where are you?
- How many people are involved?

### B – Be safe

It is important that you and your customers are safe and kept out of danger. Ask yourself:

- Where is the safest place for me and my customers?



## C – Call for help

When you are safe, you need to get the best help and advice.

- If 'safe' is on the bus – call **Code Red** (keep the button pressed for at least two seconds to connect to NMCC and press the footswitch to speak)
- If 'safe' is 50 metres away from the bus – Call **Code Red** from another bus or call the emergency services on 999

## D – Do as advised

- Listen to what NMCC/the emergency services have advised as they are the experts

## Avoiding conflict

We want you to stay safe. Occasionally, customers may become aggressive so here are some guidelines to help keep you from harm:

- Stay in your cab if you feel unsafe
- Look and listen for signs of anger, such as shouting or swearing
- Be aware of your own tone of voice or body language. Do not use sarcasm as this could make the situation worse



- Assess the risk of harm to yourself and your customers. If you are out of your cab for any reason, think about your exit route and, if possible, put some distance between you and the threatening individual
- If customers raise their voice at you, politely but firmly ask them to stop, rather than tell them
- If a customer is making a complaint, listen to what they have to say, acknowledge their point and offer a genuine apology, even if you think it is not your fault. This will calm most situations
- Try to offer the customer help or a way out of the situation. For example, explain that they can complain to TfL (if this is appropriate) and point out the contact information on the main on-bus notice
- If you feel threatened and unable to resolve the issue yourself, call **Code Red** immediately. NMCC will tell you what to do and send help if necessary
- Remember, you have the right to carry out your work without the fear of attack, and this is widely publicised across the network





## Workplace Support Team

If you are assaulted, the Workplace Support Team (WST) can help you.

If you call **Code Red** and the police can attend, report the incident to them. If they are unable to attend, you still need to report the crime. This can be done by calling 101 or by going to a police station and quoting the computer aided dispatch (CAD) reference number given to you by NMCC. A member of police staff from the WST will contact you.

### **The WST will assist in investigating:**

- Physical assaults
- Offences involving weapons and firearms
- Offences with aggravating factors (for example, hate crimes or unwanted sexual attention)
- Spitting (if it lands on your skin – see below)

If you have been spat at, you can use a DNA collection kit to gather a saliva sample. Saliva that lands on clothing or the assault screen could be contaminated by another person's DNA. Samples from the skin provide the best chance of identifying the offender.



# Security and terrorism awareness

Attacks and serious situations are rare, but we all have a responsibility to know what to do if something does happen. Customers will be looking to you for guidance and help, so you must remember and act on your ABCDs (see page 8):

**A – Assess the situation**

**B – Be safe**

**C – Call for help**

**D – Do as advised**

Remain vigilant at all times, both on and off duty. Trust your instincts and have the confidence to report things that don't seem right. You could save lives.

## Suspicious packages

Security begins before customers board the bus.

- Check the bus for unattended bags or packages:
  - Before leaving your garage
  - At the end of each journey
  - When you get back to the garage

- Ask customers if the suspect item belongs to them. Do not touch or move it
- Use the HOT procedure to determine whether a package is suspicious:
  - H – Hidden:** Has the package been hidden?
  - O – Obvious:** Is it obviously suspicious?
  - T – Typical:** Is this typically left behind on a bus by accident?

**If it is suspicious:**

- Evacuate customers from the bus, switch off the engine and call **Code Red** from another bus radio at a safe distance away (50 metres – roughly the length of five buses)
- You can also call 999 using a landline. If you use a mobile phone make sure you are at a safe distance (as above, we recommend you move 50 metres away)
- Do not touch or move the package yourself
- Do not drive into a bus station



## Suspicious behaviour

Suspicious behaviour can take many forms. Remember to focus on the behaviour and not the individual's appearance.

If you see a customer acting suspiciously (for example, if they are wearing heavy clothing during hot weather) or a customer tips you off:

- You must pull over safely (not at a bus stop)
- Evacuate your customers – tell them the bus has broken down – and switch off the engine
- Call **Code Red** from another bus radio at a safe distance away (50 metres – roughly the length of five buses) as the person may have left a suspicious package on your bus
- You can also call 999 using a landline. If you use a mobile phone make sure you are at a safe distance (as above, we recommend you move 50 metres away)
- Stay near the scene to identify yourself when police arrive
- Be prepared to give a description of the suspicious person and their behaviour
- When you have been cleared by the police, call **Code Red** and let NMCC know



## Weapons – knife or firearms attacks

If you see or hear an attack outside the bus, the best action may be to keep driving away from danger, if there is a safe route. If this is not possible, tell your customers to hide. Once it is safe, evacuate the bus only if it DOES NOT put you and your customers in greater danger. This is how you should respond to a firearms or weapons attack while on your bus – Run, Hide, Tell.

### Run:

- If there is a safe route, run – if not, hide
- Insist others go with you
- Don't let them slow you down
- Leave all belongings behind

### Hide:

- If you can't run, hide
- Take cover from gunfire
- Be aware of your emergency exits
- Be very quiet and turn off mobiles

### Tell:

- When safe, call **Code Red** or dial 999
- Give details of your location
- Describe attacker/s and weapon/s
- Stop others from entering the area, if you are able to



## Corrosive substances

Remember your ABCDs (see page 8). Don't touch the person, the chemicals, the bus or the immediate area.

### Ask yourself:

- Where is most safe for you and your customers – on or off the bus?

Call **Code Red** so the experts can get to you as soon as possible.

### For information only:

In the event of an acid attack, a constant flow of water will be required for at least 20 minutes to wash the substance away. Whoever assists, they must not contaminate themselves by touching the person or by coming into contact with the water being used to remove the acid.

For the individual being treated, the pain will quickly reach an extreme level as the water will dramatically increase the temperature. However, it will soon cool and wash away the acid. They should be warned that they may experience a warm sensation.

### You said, we did...

This is one of a series of posters produced during 2018 to help customers understand that it is not acceptable to abuse our people. The posters support the information provided to bus staff.



# London bus driver's guide to tickets and passes

- 139 Cash-free operation on London's buses
- 141 Oyster and contactless cards
- 151 Tickets and passes that customers show the driver
- 163 Customers who do not need to show a valid ticket
- 164 Still accepted but no longer on general sale
- 165 Tickets not usually accepted on buses
- 166 Unpaid Fare Reports and Pass Withdrawal Envelopes
- 170 Helpful ticketing information





Emergency fare charged

oyster

Transport for London



# London bus driver's guide to tickets and passes

This guide gives you some basic information about ticketing on London's buses. Other ticketing information you may see includes:

## Using your ticket machine and dealing with smartcards

An overview of your ticket machine and how it works, with additional information about your MDT.

## Using your wireless ticket machine

Details of the rebuilt ticket machine and how it works.

## A driver's pocket guide to tickets and passes accepted on London's buses

More detailed information about ticketing on London's buses with more printed ticket and card images.

This information is correct at the time of printing (March 2019).

## Cash-free operation on London's buses

London's buses have been cash-free since 2014. Customers who try to use cash should be asked if they have another means of paying for their journey. If they do not, they should be politely refused travel on your bus unless you feel they could be vulnerable.

See page 140 for information about vulnerable customers.

### One more journey

This Oyster card feature allows the customer to 'dip' into their balance if they do not have the price of the full fare remaining on their card. If they have at least £0.00 available, they will hear a different sound on the ticket machine and 'Emergency fare charged' will appear on the driver and customer displays. You can help by politely explaining that they will need to top up before their next journey. The reader shows a green light and emits high-low-high beeps.

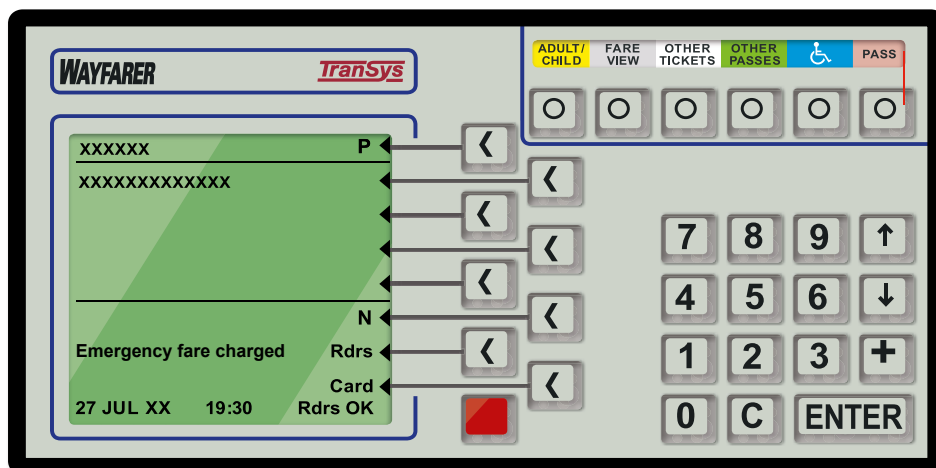



## Hopper fare

Customers who have used pay as you go on Oyster or contactless cards can make unlimited journeys for one single fare when they change bus within one hour of touching in on the first bus.

## Vulnerable customers

Do not leave anyone stranded if they are vulnerable or obviously in distress. This includes:

- Young or older people
- People who could be at risk if left behind, especially during quiet times and in isolated places
- People who are disabled, injured, unwell, frightened or who have had an accident, experienced an assault or similar incident
- Customers who show you a travel support card or Please offer me a seat card and who may appear confused. They may have an invisible impairment or condition – not all disabilities can be seen

If you decide to let someone travel in these circumstances, you must issue an Unpaid Fare Report (UFR), as a receipt for travel, in line with PSV Regulations. For more information, see page 166.

## Oyster and contactless cards

Listen for the beeps and watch your ticket machine screen. Do not press the **PASS** button for a valid Oyster or contactless card – the card reader records it for you.

Customers using an Oyster or contactless card must touch it flat on the yellow card reader when they board. If they present a card and nothing is displayed on your ETM screen, ask them to try again. If it keeps being rejected, it could be that the customer has more than one card in their wallet. In this instance, they should take out the card they wish to use and re-present it to the reader. Otherwise, they will have to use another valid ticket or card.

**Note: Reference to contactless cards includes contactless payment using mobile electronic devices (such as watches, wrist bands, mobile phones and tokens).**



## Oyster or contactless card validity

### Valid

Green light on the reader and one short beep (or eight quick beeps for Oyster photocard used by under-16s).

The reader will show details of the card on both the customer and driver displays.

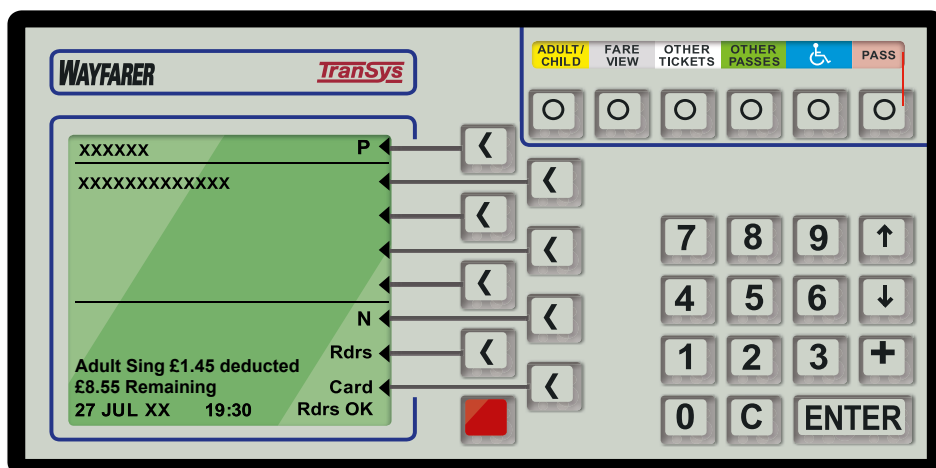

### Not valid

Red light on the reader and two low beeps.

## Card not read or more than one card presented

If the card is not touched flat on the yellow target of the card reader, the ticket machine may reject it and display 'card not read – try again' or 'more than one card presented'.

Ask the customer if they have more than one card in their wallet. If they do, they will experience card clash. They should take out the card they wish to use and re-present it to the reader. If it keeps being rejected, the customer will have to use another valid ticket or card.

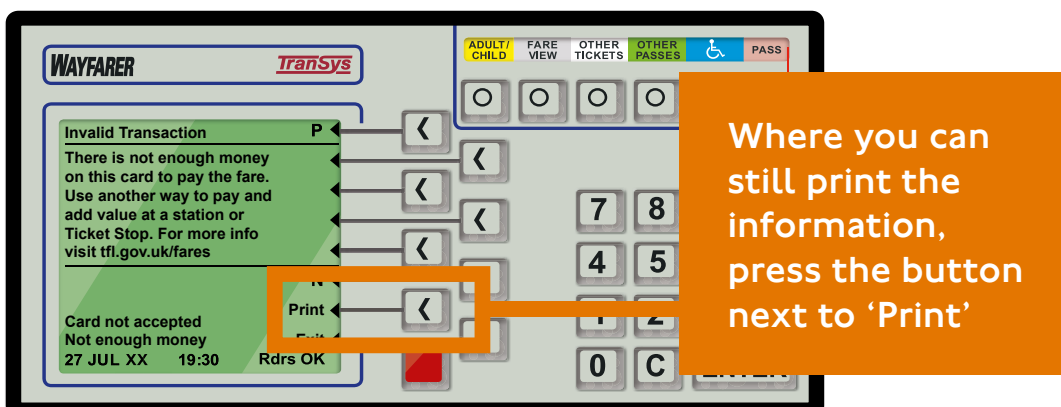
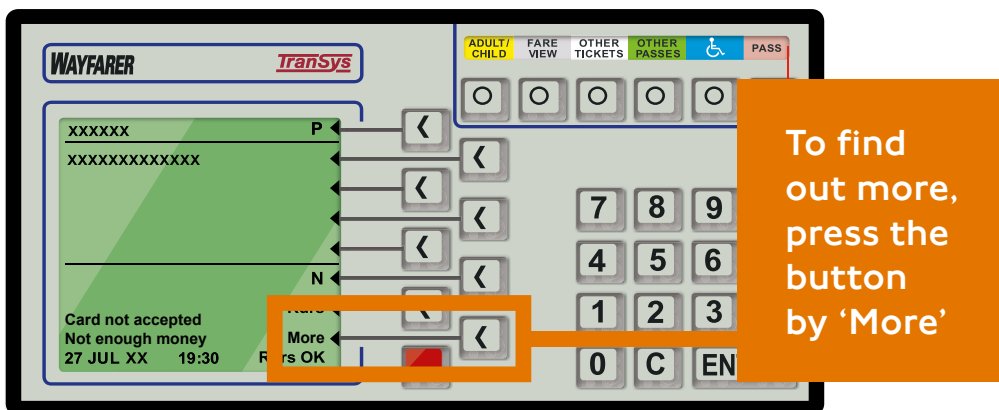



### Other card problems

The driver and customer displays will show what is wrong.

You can help by politely explaining the situation to the customer. If they still want to travel, they will need to use another valid ticket or card.

### Other transport smartcards

Other transport smartcards with a valid Travelcard loaded on to them will be accepted for travel by your card reader.

If another operator's smartcard or an English National Concessionary Travel Scheme (ENCTS) pass is touched on the card reader, the ticket machine will reject it and display 'ITSO card, not accepted'. Ask to see the card. If it is an ENCTS pass, you should accept it if it is valid (see page 151).

For any other smartcard, you should explain that you currently cannot accept it for travel and ask the customer if they have another valid ticket or card.

We will let you know if this changes and ask that you look out for driver notices.





## Under-11s

Under-11s travel free and do not need to show any valid ticket or pass to travel, unless they look older. If this is the case, they should use a 5-10 Zip Oyster photocard.

## 11 to 18-year-olds



Young people, over 11 years of age, can travel for free or at a discounted rate on London's bus network on production of a valid Zip Oyster photocard. This includes:

- 11-15 Zip Oyster photocard – entitles 11 to 15-year-olds to free travel
- 11 to 15-year-olds using an 11-15N Zip Oyster photocard pay half-rate fares. See page 146
- 16+ Zip Oyster photocard – London residents aged 16 and 17 get free travel while non-London residents get half-rate travel

Wearing a school uniform does not automatically allow a young person to travel free. Only holding and using a valid Zip Oyster photocard entitles them to free or reduced-rate journeys.

Do not withdraw a Zip Oyster photocard unless it has been stopped, is badly damaged or defaced, or is obviously not being used by the person it was issued to.

- A school authorisation letter is not acceptable as a valid ticket
- If the card is not valid (red light, reader beeps twice) and there is insufficient balance, ask to see the customer's Zip Oyster photocard. If it displays their photograph and is a card that allows free travel, they should be allowed to travel on your bus. If it is not a card that allows free travel, they should use another valid ticket or card. It has been rejected because the customer owes money for a rail journey, so please ask them to top up their card as soon as possible
- Zip Oyster photocards that show 'N' (for example I1-I5N) do not allow free travel – holders pay half-rate fares. These are issued where the photocard holder has had free travel withdrawn or withheld



- 11 to 15-year-olds may show a Day Travelcard – there is no need for an accompanying photocard

See page 140 for information about vulnerable customers.

On this page and the next page a selection of Oyster cards are shown for your information.

### Apprentice/War Veteran/Elite Athlete Oyster





60+ Oyster photocard



Bus & Tram pass

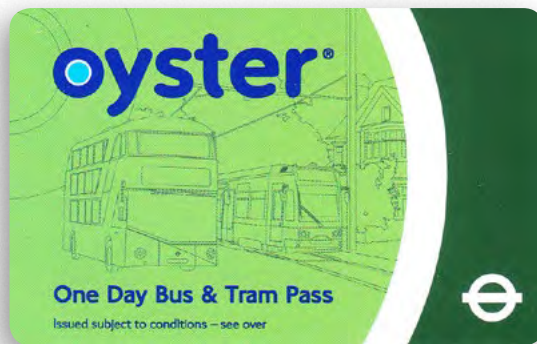

Staff Oyster cards

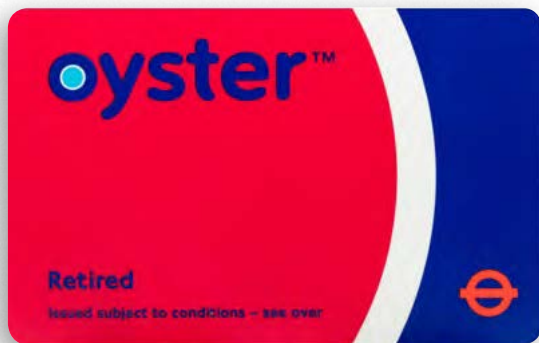



## Freedom Passes

These are Oyster-style cards that allow qualifying older Londoners and qualifying disabled people of any age to travel free.

They look similar to the ENCTS pass but clearly show 'Freedom Pass' instead of a local authority name.

When they are touched on the card reader, both you and the customer will see 'Freedom Pas' on the ETM, but only you will see 'E' for an older person's card or 'D' for a disabled person's card.

Remember that not all impairments and conditions can be seen. Only ask to see a customer's card if you have a good reason to suspect it does not belong to them, and always ask politely.

- All Freedom Passes are valid at any time on London's buses
- Freedom Passes do not allow free travel for companions
- Blind, disabled or older people may need help to use the card reader. Do not insist they use it if it causes them a problem
- A blind or partially sighted person with a guide dog does not need to show a concessionary ticket or validate a Freedom Pass to travel (see page 163)
- Wheelchair or mobility scooter users do not need to have, or show, a concessionary ticket or validate a Freedom Pass to travel (see page 163)

- Some people use a disabled person's Freedom Pass that is valid on London's buses only. These cover a range of disabilities, some of which are invisible and not covered by the national scheme
- Customers aged 60+, not yet eligible for a Freedom Pass, can use a 60+ London Oyster photocard. These are accepted on buses in the same way as an older person's Freedom Pass (see page 148)

If a Freedom Pass shows as 'not valid' on the card reader:

- Politely ask to see the customer's card
- Check it is their photograph and look at the date
- If everything seems ok and the photograph is a true likeness, allow the customer to travel (press the **OTHER PASSES** button once) and advise them to get a replacement Freedom Pass



**Older person's  
Freedom Pass**



**Disabled person's  
Freedom Pass**



**Disabled person's  
Freedom Pass  
(London only)**

## Tickets and passes that customers show the driver

### ENCTS pass

Older and disabled people across England can travel free anywhere on London's bus network with the ENCTS pass. It looks similar to a Freedom Pass, but it does not currently work on Oyster readers, so holders must show it to you.



Press the **OTHER PASSES** button once to record each customer with this kind of pass.

Each pass includes:

- A red Tudor rose logo
- A red ribbon forming a St George's cross
- A hologram

**Please note:**

- On TfL bus services, the ENCTS pass is valid at any time, just like the Freedom Pass
- Some TfL bus services that operate beyond Greater London to Buckinghamshire, Essex, Hertfordshire, Kent and Surrey may offer additional features, such as free travel for companions. Drivers on these routes should check their route information sheets for further details
- Companions do not get free travel for journeys that start and finish within Greater London
- Older and disabled people's passes from outside London are not valid for free travel on trams, the Tube, Docklands Light Railway (DLR), London Overground and National Rail services
- Older and disabled people's passes issued in Northern Ireland, Scotland and Wales have different logos and images and are not valid for free travel on London's bus network





## Tickets and passes

Press the **PASS** button once to record each customer. This helps us to monitor the number of people using our services.

## Bus Passes and Travelcards

There are a number of tickets and passes that customers can use across the London bus network. You should look out for the following:



Check the expiry date. Tickets are valid up to 04:30 the following morning. For example, if it says '31 DMR', you can accept it until 04:30 on 1 January.

## Day Bus & Tram Passes and Travelcards

Under-16s can use a child-rate Day Travelcard instead of an Oyster photocard. Anyone aged 16 or over must use an adult-rate Day Travelcard.

Day Bus & Tram Passes and Anytime Day Travelcards can be used from 00:01 on the date printed on the card, until 04:30 the following morning. Anytime Day Travelcards are issued Monday to Friday (except public holidays).

Off-peak Day Travelcards can be used from 09:30 Monday to Friday, and from 00:01 on Saturday, Sunday and public holidays. They are valid for the date printed on the card up until 04:30 the following day.

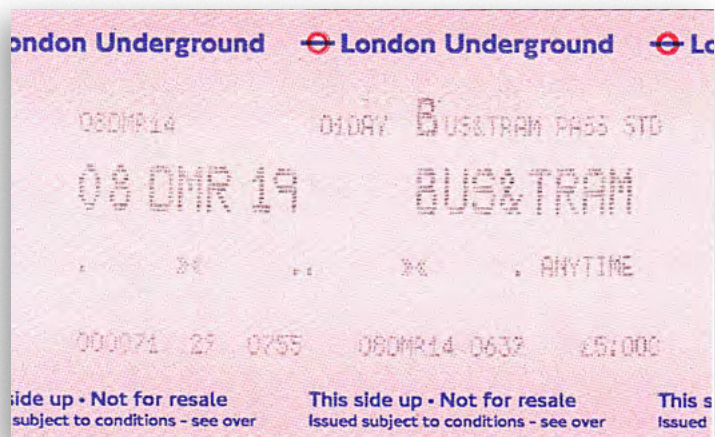

## 7 Day and longer-period Travelcards

- Adults only need a photocard with a printed Travelcard lasting one month or longer
- Under-16s need a photocard with a printed Travelcard that lasts seven days or longer

## Puppy walkers

Puppy walkers train guide dogs. They are not blind but can travel free with their puppy on either deck if they produce their pass. These passes will show 'Staff' or 'Volunteer'.

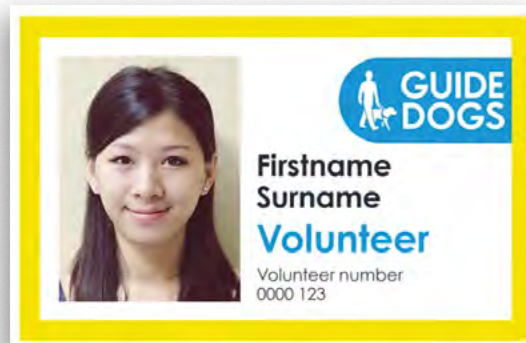

## Armed Services personnel

Members of the Armed Services (Army/Navy/Air Force/Reservists) who are in full uniform and show a valid military ID can travel free on London's buses.

- Check the expiry date
- Armed Services personnel not in full uniform must show another valid ticket or validate a card

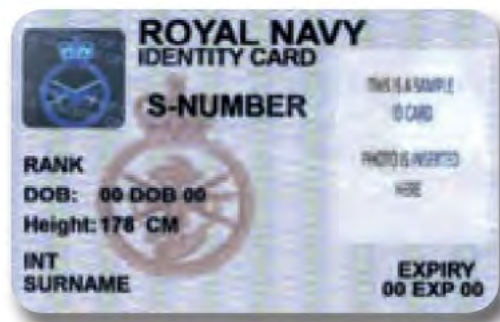



## School party ticket

This is valid after 09:30 and before 16:30 on school days only.

One ticket allows a group of up to 10 school children aged 18 or under to travel with a maximum of two adults.

- If there are disruptions on the network, the return journey can start after 16:30
- Each group will only have one ticket, which they keep. However, the **PASS** button should be pressed for every member of the group



### Temporary Authority to Travel Ticket

RPIs sometimes issue Temporary Authority to Travel Tickets (TATTs) to customers after withdrawing a ticket or pass. The RPI will make the TATT valid by highlighting the sections that apply to the customer, as shown.





## Police officers and special constables

London's police officers – those in the British Transport Police, City of London Police and Metropolitan Police Service – have been issued with a Police Oyster card that allows free travel at all times on London's bus network and works in the same way as a staff Oyster card (see page 148).



Officers from other surrounding county forces will need to show you their warrant card instead.

**Please note:**

Free travel is offered, at all times, to these other forces only:

- Essex Police
- Hertfordshire Police
- Kent Police
- Surrey Police
- Thames Valley Police







## Police Community Support Officers

Free travel is offered, at all times, to holders of a police staff card and a red or blue Bus Pass.

- The police staff card on the left can only be used by itself if the holder is in full uniform

### Please note:

Police Community Support Officers (PCSOs) are highly trained and help to make travel on our network safer. If an incident occurs on the bus, PCSOs can help by:

- Acting as witnesses if required
- Using their training in emergency life support, evidence gathering and communicating with the public
- Calling the police or other emergency services



### Parking/Council attendant staff pass

Free travel is only permitted with this pass when the holder is in full uniform.



### How do I recognise a Revenue Protection Inspector (RPI)?

RPIs have a silver metal badge in a black wallet, which they will show you. The RPI's number is displayed on the badge (below the TfL roundel).

- If you think someone may have been trying to avoid using a valid card or ticket, tell the RPI when they board your bus
- If you had good reason not to issue an Unpaid Fare Report to a customer who did not have a valid card or ticket, or they walked off before you could issue one, tell the RPI immediately



# Customers who do not need to show a valid ticket

## Children under 11

Press the **PASS** button once to record each customer.

Children under 11 do not need to have, or show, a ticket or photocard unless they look older (see page 145).

## Blind and partially sighted people with guide dogs

Press the **PASS** button once to record each customer.

Blind and partially sighted people with guide dogs do not need to show their concessionary ticket or Freedom Pass. This is because it can be difficult to touch their pass on the reader while holding the dog's harness.

Those without guide dogs also travel free, but should validate their Freedom Pass or show an ENCTS pass.

## Wheelchair or mobility scooter users

Press the  button once to record each customer using a wheelchair or mobility scooter.

People who use these mobility aids do not need to have, or show, a ticket or photocard. However, their companions do not automatically travel free – they must show a valid ticket or validate a card.

## Still accepted but no longer on general sale

Although they are not on general sale, these tickets must be accepted for travel as they are still issued to certain people and organisations.

### 7 Day Bus & Tram Passes



### Saver tickets

- Keep the hexagonal part that says 'Staff receipt only' until the end of the trip. When an RPI boards your bus, you must give the staff receipts to them
- If there is a crew change during a trip, give the staff receipts to the new driver
- At the end of the trip, tear the staff receipts in half completely and dispose of them in a bin



## Tickets not usually accepted on buses

Tube, DLR and rail-only tickets (either printed or handwritten) are not usually accepted on the London bus network.

You may have to accept these tickets when there is disruption on Tube, rail or DLR services. If this is the case, you will be told by NMCC over your radio and given a three-digit resolution number. If there is a planned rail closure, a fares notice will be posted at your garage to say where and when tickets should be accepted.

### What to do with a resolution number

This is used to prevent customers from being overcharged when there is disruption on Tube, rail or DLR services.

On your ETM, press the  button once:

- Select 'End Journey' and sign on to the ticket machine again
- As you sign on, 'LUL Resolution?' will come up on the screen. Press the 'up' arrow to select 'Y'
- Type in the resolution number when the screen says 'LUL No'
- Until usual services have resumed, answer 'Y' to 'LUL Resolution?' when you sign on to the ticket machine for your next trip



## Unpaid Fare Reports and Pass Withdrawal Envelopes

In line with PSV Regulations, you must issue a UFR (as a receipt for travel) when:

- A customer is potentially vulnerable or distressed and does not have a valid ticket or card. This includes:
  - Young or older people
  - Those who could be at risk if left behind, especially in isolated places or at quieter times
  - Customers who are disabled, injured, unwell, frightened, or who have had an accident or experienced an assault or similar incident
  - People who show you a travel support card or Please offer me a seat card and may appear confused. They may have an invisible impairment or condition – not all disabilities can be seen

### Remember:

- Do not put yourself at risk, especially if you do not feel comfortable challenging the customer
- Think about how you would want to be treated if you were in the same situation

### How to use UFRs:

- Always fill in the driver section completely, including the date, time, route number and full location. Ask the customer for their postcode, unless you feel this could lead to a confrontation

- Make sure you tick a 'reason for issue' box and add extra information on the back that would be helpful. This enables us to identify routes and times that RPIs should be targeting
- Please do not use abbreviations as the police and revenue teams will need as much detail as possible to help establish where and when UFRs are being issued
- Tear off the bottom part of the UFR and give it to the customer. Politely explain that they will need to pay their unpaid fare within five days
- When you return to the garage at the end of the day's duty, hand in the completed top parts of any UFRs issued
- If you have good reason not to issue a UFR to a customer or they walked off before you could issue one, use the pre-loaded SMS text message 'Fare evasion' on iBus (see page 122)

**Unpaid Fare Report – Driver copy**

Date       Time

Route  UFR **0000000**

Location

Passenger's home postcode

**Reason for issue (tick box and add details overleaf)**

Confrontation  Vulnerable/in distress

Other (reason must be given on other side)

---

**Unpaid Fare Demand – Passenger copy**

Date       Time

Fare due  UFR **0000**

This form authorises you to travel on the bus on which it was issued. See the other side for ways to pay.

**You must pay the outstanding fare within five days of issue.**

## Pass Withdrawal Envelopes

- Do not put yourself at risk, especially if you do not feel comfortable challenging the customer. Instead, use the pre-loaded SMS text message 'Fare evasion' on iBus (see page 122)
- Complete a Pass Withdrawal Envelope (PWE) when you feel comfortable challenging a customer to withdraw a damaged or invalid ticket or Oyster card/photocard. Do not withdraw a Freedom Pass or ENCTS pass, unless it is being used by someone other than the registered owner. Do not withdraw a contactless card
- On the envelope, always fill in the date, time, route number and location. Also, fill in the reason for the withdrawal. This information will help us track why a ticket or Oyster card was withdrawn
- Tear off the PWE and seal the top part. Hand this in at your garage at the end of that day's duty
- Tear off the customer's copy and give it to them. Politely explain that they will need to pay any unpaid fare within five days

**Pass Withdrawal Receipt – Passenger copy**

Date  Time

Fare due  PWE **0000000**

Must be paid within five days

Your pass/ticket has been withdrawn because it is not valid for this journey. It is your responsibility to ensure you have the correct pass/ticket for your entire journey.

This receipt allows you to travel on the bus on which it was issued. If you owe an outstanding fare, you must pay within five days of issue.

To appeal this withdrawal, write to the address below, quoting the reference number above. Transport for London will not be liable for any travel costs.

**Ways to pay:**

- **At any Tube station ticket office**
- **By phone**  
Call **020 3054 0326** to use your credit or debit card
- **By post**  
Send cheque or postal order [payable to Transport for London] to: **Bus Enforcement, PO Box 68800, London SE1P 4RE**

---

**Pass Withdrawal Envelope – Driver copy**

Date  Time

Route  PWE **0000000**

Location

**Reason for withdrawal (tick box and add details overleaf)**

Altered/defaced <input type="checkbox"/>	Transferred <input type="checkbox"/>
Out of date <input type="checkbox"/>	Stopped <input type="checkbox"/>
Copied <input type="checkbox"/>	Other <input type="checkbox"/>

Fare due





See page 171 for more information about withdrawing tickets and cards.

If an RPI gets on your bus, tell them if you have issued any UFRs or customer copies of PWEs on that trip.

If you had good reason not to issue a UFR to a customer who did not have a valid ticket or card, or they walked off before you could issue one, tell an RPI immediately.



## Helpful ticketing information

### Problems with paying

Very few printed tickets are now used on London's buses. Oyster and contactless cards, and contactless payment via mobile devices, make things easier for everyone. The following pages highlight some typical problems you might come up against and advice on how to deal with them.

### What if a customer cannot, or will not, show a valid pass or validate a card?

- Do not allow them to travel (except in the circumstances below) and do not accept cash. Be polite but firm
- However, do not leave anyone stranded if they are vulnerable or obviously in distress. This includes:
  - Young children or older people
  - Anyone who might be at risk if left behind, especially in isolated places or at quieter times
  - Customers who are disabled, injured, unwell, frightened or who have had an accident, or experienced an assault or similar incident
  - People who show you a travel support card or Please offer me a seat card, and who might appear confused. They may have an invisible impairment or condition – not all disabilities can be seen

- If you decide to let someone travel in these circumstances, you must issue a UFR (see page I66)
- Do not put yourself at risk, especially if you do not feel comfortable challenging the customer
- If you have good reason not to issue a UFR to a customer or they walked off before you could issue one, use the pre-loaded SMS text message 'Fare evasion' on iBus (see page I22)
- Think about how you would want to be treated if you were in the same situation

### **What if a customer presents an invalid ticket or card?**

- Point out the problem and explain that they need to use another valid ticket or card
- Always be polite and never accuse anyone of fraud. The customer might not have realised their pass has expired or is out of credit
- Never withdraw a card if it has failed. Advise the customer that they should get it replaced immediately and explain that they need to use another valid ticket or card
- Do not withdraw an Oyster card because the customer does not have enough money. Simply explain that they need to use another valid ticket or card



- You can only withdraw an Oyster card or printed pass if:
  - The card has been damaged or defaced (such as a broken Zip Oyster photocard)
  - It is obviously not being used by the person it was issued to
  - It is a stopped Oyster card
  - It is a printed pass that is more than one day out of date or an obvious forgery (see page 168)
- You must never withdraw a contactless card – it is the customer's credit/debit card as well as their ticket
- Do not put yourself at risk, especially if you do not feel comfortable challenging the customer. Instead use the pre-loaded SMS text message 'Fare evasion' on iBus (see page 122)
- If necessary, use the Vulnerable Person Procedure to allow customers to travel, and issue a UFR (see page 166)

### **What if a customer aged 11 to 18 claims free travel without an Oyster photocard?**

- Explain that they must touch their Oyster photocard on the reader to get free travel
- If they are not willing to pay using a valid ticket or Oyster card, you can refuse to take them (unless they could be vulnerable)
- Use your common sense and do not leave young people stranded if they could be in a vulnerable position or are in obvious distress. Instead, issue a UFR (see page 166)

- If there are too many under-18s to stop them all, and you feel unsafe, call **Code Red**. Otherwise, use the pre-loaded SMS text message 'Fare evasion' on iBus (see page 122) or complete an occurrence report when you are back at the garage and tell us the location(s) of any regular problems

### What if my ticketing equipment breaks down?

- Report it immediately so it can be replaced quickly
- If the card reader is not working or is not fitted, allow all customers with Oyster or contactless cards to travel without having to use another valid ticket
- People without Oyster or contactless cards still need to show a valid printed ticket in the usual way
- Speak to a supervisor if you are unsure or if you have any problems

### What if my bus breaks down or is turned?

- If this happens short of the original destination, customers should be transferred on to another London bus service going the same way
- Remind customers who have used pay as you go that the Hopper fare allows them to make unlimited journeys for one single fare when they change buses within one hour of touching in on the first bus
- Make sure all your customers have been able to safely board another bus (see page 34)



### What if a customer's Oyster or contactless card is not accepted for travel?

- Ask the customer if they have more than one card in their wallet. If so, they could experience card clash. They should take out the card they wish to use and re-present it to the reader
- If the card is not working, there is little you can do to solve the problem, but always be patient and polite. Ask the customer to try again, touching their card flat on the yellow target of the reader
- If it still does not work, use the information on the card reader display to explain what is wrong and print it out if necessary, where you are still able to do this
- Customers can get help to sort the problem via:
  - [tfl.gov.uk/fares](https://tfl.gov.uk/fares)
  - Tube stations
  - Customer Services on **0343 222 1234**
  - Their card issuer, for contactless cards or devices
- Freedom Pass holders do not have to pay if their card is not working, provided you have checked the expiry date and their photocard is a true likeness. If it has been stopped, advise the customer that they need to get their pass replaced as soon as possible



### What if a customer says there should be more money on their Oyster card?

- There could be a number of reasons for this, and there is little you can do
- If they have been allowed 'one more journey' on their Oyster card, they can continue to travel on your bus. Explain that they need to top up their card before making their next journey
- If a customer boards your bus at night, you can issue a UFR for further travel if you feel they could be vulnerable (see earlier question, 'What if a customer cannot, or will not, show a valid pass or validate a card?')
- If you do not feel a customer could be vulnerable, they must use another card or valid ticket if they want to travel. They can contact Customer Services or their card issuer to sort out the problem
- Remember that a receipt is not valid for travel

### What if an RPI gets on my bus?

- If you think someone may have been trying to avoid using a valid card or ticket, tell the RPI when they board your bus
- If you had good reason not to issue a UFR to a customer who did not have a valid ticket or card, or they walked off before you could issue one, tell the RPI immediately



### What if a customer wants to know where to buy tickets and Oyster cards, top up their Oyster card or get a refund?

- Advise them to ask at:
  - Oyster Ticket Stops
  - TfL Visitor Centres
  - Staffed National Rail stations
  - Tube stations
- Or:
  - Visit our website at [tfl.gov.uk](https://tfl.gov.uk). There are also details of how to order top-ups, Travelcards and Bus & Tram Passes online and collect them 30 minutes later by touching in on the bus
  - Call Customer Services on **0343 222 1234**



### You said, we did...

This is one of a series of posters produced during 2018 to inform our customers about the ability to top-up via an app on their phone or device. It supports the information provided to bus staff.

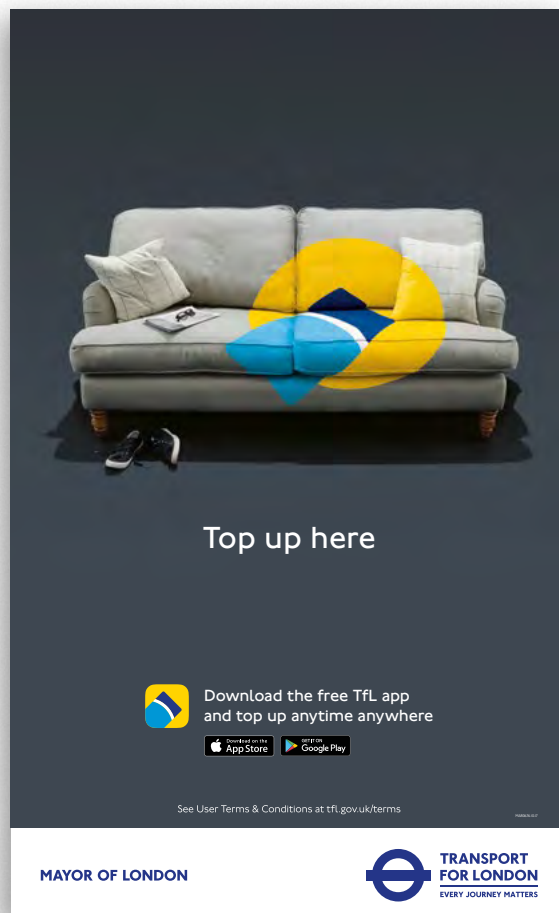

# Further helpful information

179 Useful contacts

181 What does it mean?

190 Where can I find...?

198 Notes

## Useful contacts

### TfL Customer Services (including Oyster and contactless card questions, plus travel information)

0343 222 1234

(08:00–20:00, Monday to Friday)

### TfL's Lost Property Office

0343 222 1234

(08:30–16:00, Monday to Friday except public holidays)

Any lost property found on your bus should be kept in a secure place until you can hand it in at your garage at the end of your shift.

### Live bus departures

[countdown.tfl.gov.uk](https://countdown.tfl.gov.uk)

### Text messages

Customers can send a text to **87287** with the unique bus stop code and we'll send a reply with live bus arrival information for that stop. From overseas networks, they should use **+44 7797 800 287**.

Texts cost the standard network rate, plus a small charge to receive the response. Texts via overseas networks are charged at the network's standard roaming rate only, but are limited to five per day. See [tfl.gov.uk](https://tfl.gov.uk) for more details.





**If you see a vandalised bus stop/shelter**

Call **0800 731 3699** or NMCC (**Code Blue**)

**If you see or are told about a fault with the Live Bus Arrivals service or a Countdown sign**

Email details of the fault to:

**TechServicesHelpdesk@tfl.gov.uk**

**Report it**

Report disruptive roadworks at **tfl.gov.uk/roadworks**

or by tweeting **@report\_it** with the hashtag **#roadworks**

**TfL website**

**tfl.gov.uk**

The following pages are for you to make a note of anything you want to know that is not covered in this book.

If there is anything you would like to ask or tell us about, let us know by texting **07860 023080\*** or emailing **busdriverfeedback@tfl.gov.uk** and we'll get back to you.

\*Your normal network rate applies

## What does it mean?

**Accessibility ramp** – The ramp fitted to low floor buses is often referred to as a wheelchair ramp. Its actual purpose is to allow anyone who needs it to be able to board the bus, if that is easier than using the front door, subject to the 300kg weight limit (see page 95).

**Advanced stop box** – at junctions, this is an area at the top of a road where cyclists can wait at the front of traffic at an advanced stop line. All other vehicles, including buses, should not stop in this box and should wait at the first stop line (see page 72).

**Assistance dogs** – specially trained dogs that help disabled people to travel more independently. All assistance dogs are welcome on London's buses. There is no limit on the number you can allow on your bus (see page 90).

**Bus Customer Experience Survey (BCES)** – The BCES looks at the experience of bus travel from the customer's point of view. The assessors, employed by an external agency, travel on different buses for about 15 minutes each time looking at the cleanliness of the bus as well as the helpfulness and driving skills of the driver. Drivers get a score out of 100, with 100 being the best.

**Bus stand** – a place away from the bus route where a bus may stand. The engine should be switched off on arrival (see page 28).

**Bus station controller** – TfL staff who help to maintain safe operation in and around bus stations (see page 29).



**Card clash** – if a customer has more than one card in their wallet, they will experience card clash and the reader will reject their cards. You should ask them to take out the card they wish to use and re-present it to the reader (see page 143).

**Cash-free operation** – on London's buses we no longer accept cash to pay fares. Customers need to pay for travel using an Oyster card, contactless payment card or printed ticket (see page 139).

**CentreComm** – former name for London Buses' emergency command and control centre. Now known as the Network Management Control Centre (see page 113).

**Closed-circuit television (CCTV)** – cameras are fitted in various places on London's buses to digitally record visual images for safety, security and crime prevention.

**Code Blue** – when you need to report an incident (not an emergency), press the blue button on your MDT to call NMCC (see page 116).

**Code Red** – when you need emergency help, press the red button on your MDT to call NMCC (see page 114).

**Computer aided dispatch (CAD) reference number** – if you are a victim of crime, you will be given a CAD reference number by the police. They will use this to refer to your case (see page 129).

**Contactless card** – a credit or debit card issued by a bank or building society that includes the 'contactless' symbol and can be used for contactless payments. Note:

- The card is a customer's ticket so can only be used by one person at a time
- Many cards issued by foreign banks will not work on bus readers



**Curtailement** – you may be asked to turn your bus short of its usual destination by a bus company official, a TfL official or the police. When this happens, you should inform your customers using the PA (see page 34).

**Cycle hire** – cycles provided by TfL that can be hired by users from docking stations in central and east London.

**Cycle Highways** – in some parts of London, cycle routes are marked out in blue to help provide a clearer, direct and continuous route for cyclists (see page 71).

**Driver Quality Monitoring (DQM)** – DQM provides a technical assessment of bus driving, with a major concern for safety. The assessors, employed by an external agency, travel on different buses for about 20 minutes each time looking at the safety and smoothness of driving. The two areas of focus are, making sure the driver keeps two hands on the steering wheel as well as not going through amber lights, unless it is unavoidable, and not going through red lights at any time. Drivers get a score of Box 1 - 4, where 0 (Box 1) is the best and Box 4 is given if the driver does something dangerous. Usually drivers are given a Box 1 (no faults) or Box 2 (minor faults).



**Electronic ticket machine (ETM)** – the standard ticket machine, plus card reader, used on London’s bus network. Drivers sign-on a module at their garage which is then signed onto the ETM (see page 46).

**Electronic ticket machine wireless** – The standard ticket machine, plus card reader, used on London’s bus network but drivers sign-on using a unique PIN rather than a separate module (see page 46).

**English National Concessionary Travel Scheme (ENCTS) pass** – issued outside London, these passes allow free travel across England for older and disabled customers. The issuing area is shown on the top right-hand corner (see page 151).

**Freedom Pass** – similar to the ENCTS pass, these generally allow free travel across England for older and disabled residents of London. The words ‘Freedom Pass’ appear on the top right-hand corner (see page 149).

**Hail and Ride** – a section of bus route with no fixed bus stops, often within housing estates, where customers can hail the bus. You should only stop where it is safe to do so. Avoid areas where your view is limited or where you could block other road users (see page 27).

**Hate crime** – Hostility towards someone because of their disability, gender, identity, race, religion or sexual orientation (see page 114).





**Hopper fare** – Customers who have used pay as you go on Oyster or contactless cards can make unlimited journeys for one single fare when they change bus within one hour of touching in on the first bus.

**iBus** – the system that supports the MDT and allows your bus company, TfL and others (where necessary) to know where you are. It also provides the information for audio and visual stop announcements on your bus (see page 53).

**Lower the bus** – the facility to lower the height of the bus so that your entry and exit doors are closer to the kerb. It may help an older or disabled person to get on or off if you lower the bus before you open the doors.

**Mobile data terminal (MDT)** – the standard iBus radio unit fitted to all buses that operate on London's bus network (see page 53).

**Mobility aid** – a device that helps people to be more mobile. This could be as straightforward as a walking stick or crutches, or it could be a mobility scooter, a shopping trolley (used as a mobility aid) or an adapted buggy for disabled children (see Mobility Aid card below and page 106).

**Mobility Aid card** – a card that confirms the holder is using an approved mobility aid that can be taken on to the bus using the accessibility ramp. This is used mainly by mobility scooter users, as well as users of shopping trolleys (used as mobility aids) and adapted buggies for disabled children (see page 106).



**Mobility walkers and shopping trolleys** – a wheeled device or shopping trolley used by people to assist with their mobility. Customers may ask to use the middle doors and ramp to enter and leave the bus, and this is allowed as it is the safest and easiest way for them to do so. Mobility walkers and shopping trolleys should be positioned in the wheelchair priority area, with the user nearby (see page I04).

**Network Management Control Centre (NMCC)** – TfL's emergency command and control centre. It operates 24-hours-a-day, seven-days-a-week and monitors the bus network. NMCC is the fastest way to get help in an emergency (see page I13).

**Network traffic controller** – TfL staff who help with incidents and emergencies that affect London's bus network.

**One more journey** – a feature on Oyster cards that allows the user to 'dip' into their balance and make one more bus journey if they do not have a valid Bus Pass, Travelcard or the full Oyster fare remaining on their card. If customers have at least £0.00 value on their card, they will hear a different sound on the ticket machine. You can help by politely explaining the situation to them (see page I39).

**Other transport smartcards** – smartcards issued by other transport operators. Currently, only those with a valid Travelcard will be accepted on TfL card readers (see page I44).

**Oxygen cylinder** – a small portable oxygen canister that helps the user with their breathing and is generally carried in a bag or pouch. You should allow customers carrying these oxygen cylinders to board the bus (see page 39).



**Please offer me a seat badge and card** – many of our customers, particularly disabled people and those with invisible impairments, conditions or illnesses, find it difficult to get a seat. This free badge and accompanying card makes it easier for them to let other customers know that they need to sit down (see page 94).

**Police Community Support Officer (PCSO)** – a member of police staff who can assist and support you with issues on your route. Some of their powers are similar to those of a police officer and they are trained in particular skills such as evidence gathering and communicating with the public.

**Pre-loaded SMS text messages on iBus** – iBus includes a set of pre-loaded SMS (short message service) text messages that help to get important information to your service controller more quickly and reduces the number of radio calls (see page 122).

**Pre-recorded announcements on iBus** – another feature of iBus is a set of pre-recorded automated announcements to support you. They include 'Seats are available on the upper deck' and 'A customer needs the wheelchair priority area. Please make space' (see page 60).

**Public address (PA) system** – every bus in London is fitted with a black stub microphone, with a yellow sticker around it, that allows you to make announcements to your customers.

PA announcements can be helpful and reassuring, for example, before you go on diversion (see page 62).



**Report it** – roadworks should be tidy, safe, have clear signage to explain what is happening, and take up as little space as possible. If you see any roadworks that are not meeting these standards, report them at [tfl.gov.uk/roadworks](https://tfl.gov.uk/roadworks) or tweet [@report\\_it](https://twitter.com/report_it) with hashtag [#roadworks](https://twitter.com/roadworks).

**Resolution number** – a three-digit number that you enter into the ticket machine to prevent Oyster users from being overcharged when there is disruption on Tube or rail services (see page 165).

**Revenue Protection Inspector (RPI)** – TfL staff who are employed to ensure customers are paying the right fares and using the correct tickets (see page 162).

**T-loop** – this amplifies sound for customers with hearing aids. If the bus is fitted with a T-loop, there will be a sign on the cab door and customers should select the 'T' position on their hearing aid. The T-loop operates in the driver's cab and the area around the wheelchair priority space.

**Transfer ticket** – a voucher issued to each customer using Oyster pay as you go or a contactless payment card, when you are asked to curtail your bus and they need to transfer to another bus (as at March 2019). This facility will end when the printer is removed from your ETM, during the lifetime of this book. Remind customers that the Hopper fare allows unlimited journeys for one single fare when they change bus within one hour of touching in on the first bus.



**Transport for London (TfL)** – we are the integrated body responsible for the Capital’s transport system. Our role is to implement the Mayor’s Transport Strategy and manage transport services across London, for which the Mayor has ultimate responsibility. We manage London’s buses, London Underground, Docklands Light Railway, London Overground and London Trams. We also run London River Services, Victoria Coach Station and London Transport Museum. We manage a 580km network of main roads and London’s 6,000 traffic lights, regulate taxis and the private hire trade and run the main cycle hire scheme.

**Travel support card** – a card that allows the holder to write down important information that helps them explain their transport needs so they can travel with confidence. It may be used, for example, by someone with learning difficulties (see page 89).

**Vulnerable customers** – people who might look to you for help and could be at risk if left behind (see page 140).

**Vulnerable road users** – these are road users who could be at risk if involved in a collision with a motor vehicle, such as pedestrians, cyclists or motor cyclists (see page 71).

**Workplace Support Team (WST)** – a partnership between TfL and the Metropolitan Police Service dedicated to the investigation of assaults on frontline bus staff (see page 129).



## Where can I find...?

11 to 18-year-olds	145
Accessibility ramp	95
Advanced stop box	72
Alcohol on the bus	40
Animals on the bus	38
Announcements	
• Personal	62
• Pre-recorded	60
Assistance dogs	37, 90
Avoiding conflict	127
Bicycle (see Cycles)	
Blind and partially sighted customers	92
Branches, low hanging and other obstacles	120
Breakdowns	34
Buggies	42
• Adapted buggies for disabled children	106
Bus & Tram Pass	
• 1 Day	154
• 7 Day	164

Bus Customer Experience Survey	181
Bus stand	28
Bus station	28
Bus station controller	181
Bus stops	19 – 27
• Busy stops	21
• Stopping policy	19 – 20
Card clash	143
Cash-free operation	139
Checking tickets	30
Code Blue	116
Code Red	114
Contactless cards	141
• Mobile electronic device	141
• Problems	143
• Validity	142
Council attendant staff pass	162
Curtailments	34

Customers	
• 11 to 18-year-olds	145
• Disabled	84
• Older	85
• Unable to pay	166
• Under 11	145
Cycles	
• On the bus	39 – 40
• On the road	71
Deaf and hard of hearing customers	93
Disabled customers	84
Diversions	32
Dogs	
• Assistance dogs	37, 90
• Guide dogs	37, 90
• Other dogs	38
• Puppy walkers	155
Driver Quality Monitoring	183
Electronic cigarettes on the bus	40
Electronic ticket machine (ETM)	46



Emergency, getting help	8
English National Concessionary Travel Scheme (ENCTS)	151
Food on the bus	40
Freedom Pass	149
Getting help	8
Guide dogs	37, 90
Hail and Ride	27
Hate Crime	114, 129
Hopper fare	140
Identification codes (ICs)	121
Invisible disabilities	87
Lower the bus	185
Major incidents	125
Mobile data terminal (MDT)	53
Mobility Aid card	106
Mobility scooters	96, 106
Mobility walkers	104

Network Management Control Centre (NMCC)	113
Network traffic controller	186
Older customers	85
One more journey feature	139
Other road users	71
Other transport smartcards	144
Oxygen cylinders	39
Oyster	141
• Problems	143
• Validity	142
Paint, on the bus	40
Parking/council attendant staff pass	162
Pass Withdrawal Envelope (PWE)	168
Phonetic alphabet	124
Please offer me a seat badge and card	94
Police – free travel	159 – 161
• Police Community Support Officers (PCSOs)	161
• Police officers and specials (county forces)	160
• Police officers and specials (London)	159

Pre-loaded SMS text messages	122
Pre-recorded announcements	60
Public address (PA) system	62
Puppy walkers	155
Resolution number	165
Revenue Protection Inspector (RPI)	162
Saver tickets	164
School party tickets	157
Scooters (not mobility)	39
Security awareness and terrorism	130
Serving the stop	19
Shopping trolleys (used as mobility aids)	106
SMS text messages (available on the MDT)	122
Suspicious behaviour	132

Suspicious packages	130
T-loop	93
Temporary Authority to Travel Tickets (TATTs)	158
Text messages (available on the MDT)	122
Tickets	136
• Not usually accepted on buses	165
• Still accepted but not on general sale	164
Transfer ticket	36
Travelcard	153
• Day	154
• 7 Day and longer	155
Travel information for customers	179
Travel support card	89
Under-11s	145
Unpaid Fare Report (UFR)	166
Unwanted sexual attention	114, 129
Useful contacts	179
Vandalism	115

Victims of crime	114
Vulnerable customers	140
Wheelchair bell	15, 100
Wheelchair priority area	98
Wheelchair ramp (see accessibility ramp)	
Wheelchair and mobility scooter users	96
Workplace Support Team (WST)	129
Zip Oyster photocard	145

